



INDEX

A

ABADI Intestinal Clamp Forceps	101
Adenotomes	88
ADSON Brain Forceps	24
ADSON Forceps	68
Airway	9
ALEXANDER Cervial Biopsy Forceps	118
ALLIS-ADAIR Tissue Forceps	98
ALLIS Tissue Forceps	97-98
Applicators, Cotton	50
ARRUGA Capsular Forceps	76
ARRUGA Eye Specula	70
ARRUGA Needle Holder	54
ARTHUR Splinter Forceps	26
ASCH Septum Forceps	86
AUVARD Vaginal Specula	111
AUVARD-ZWEIFEL Cranioclast & Cephotribe	124
AXENFELD Lacrimal Sac Dissector	74
AYER Chalazian Forceps	77

B

BABCOCK Tissue Forceps	99
BABINSKY Neurological Hammer	7
BACKHAUS Towel Clamps	38
BACKHAUS-ROEDER Towel Clamp	38
BAINBRIDGE Haemostatic Forceps	32
BAKES Gall Duct Dilators	105
BALFOUR Abdominal Retractor	49
BALLENGER Gouge	87
BALLENGER Nazal Knife	86
BALLENGER Septum Knife	86
BALLENGER Sponge Forceps	41
BALLENGER Tonsil Seizing	93
BARKER Ear Curette	79
BARNES-NEVILLE Obstetrical Forceps	123
BARNES-NEVILLE-SIMPSON Obstetrical Forceps	123
BECKMANN Adenoid Curettes	88
BECKMANN Nazal Scissors	19
BEEBEE Dental Wire Cutting Scissors	22
BEER Cataract Knife	71
BEESON Plaster Spreader	58
Bell End for Chestpieces	6
BERKLEY BONNEY Hysterectomy Forceps	116
BERLINER Percussion Hammer	7
BISHOP HARMAN Iris Forceps	75

BLAKE Gall Stone Forceps	105
BLAKE Uterine Curettes	118
BLALOCK Coarctation Clamp	68
BOERMA Obstetrical Forceps	122
BONNEY Hysterectomy Forceps	116
BONNEY Myomectomy Clamp	116
BONNEY Tissue Forceps	25
BOSWORTH Tongue Depressor	91
Bougies	107
BOWLES Chest pieces	6
BOWLES Stethoscopes	8
BOWMAN Discision Needle	72
BOWMAN Eye Specula	70
BOWMAN Lacrimal Probas	74
BOZEMANN Needle Holder	52
BOZEMANN Uterine Dressing Forceps	41
BOZEMANN Vaginal Specula	111
BOZEMANN-DOUGLAS Uterine Dressing Forceps	41
BOZEMANN-FRITSCH Uterine Catheter	127
BRAUN Craniotomy Forceps	124
BRAUN Obstetrical Hook	125
BRAUN Uterine Depressor	113
BRAUN Uterine Tenaculum Forceps	114
BRAUN-STADLER Epistotomy Scissors	20
BREISKY Pelvimeter	126
BREISKY Vaginal Specula	111
BROPHY Cleft Plate Knife	93
BROPHY Dura Dressing Forceps	23
BROPHY Tissue Forceps	24
BRUCE-CLARK Needle Holder	51
BRUENINGS Septatome	86
BRUENINGS Septum Compression Forceps	84
BRUENINGS Tongue Depressor	91
BRUENINGS Tonsil Scissors	94
BRUNNER Rib Shear	66
BRUNS Bone Spoon	60
BRUNS Plaster Shear	57
BRYANT Dressing Forceps	39
BUCHWALD Tongue Depressor	91
BUCK Neurological Hammer	7
BUSCH Umbilical Scissors	20
BUXTON Mouth Gag	89

C

CARBOULD Tongue Forceps	92
-------------------------	----



INDEX

DESJARDINE Gall Stone Scoop	105
DESMARRES Chalazion Forceps	78
DESMARRES Eye Specula	70
DESMARRES Entropium Forceps	77
DEWEY Obstetrical Forceps	123
Diagnostic Set	5
Dilators, Gall Duct	105
Uterine	112-113

"E"

Ear Specula	79
Ear Syringe	79
EASTMAN Vaginal Specula	110
EICKEN—KILLIAN Frontal Sinus Cannula	87
Elevators	61,87
ELLIOT Obstetrical Forceps	121
ELSCHING Capsular Forceps	76
ELSCHING Tissue Forceps	76
EMMET Swab Holding Forceps	41
ENGEL Plaster Saw	58
ENGLISH Pattern Dissecting Forceps	41
ESMARCH Plaster Shear	57
EVES Tonsil Snare	94
Eye Specula	70

"F"

FARABEUF Bone Holding Forceps	62
FARABEUF Raspatory	61
FARABEUF Retractor	42
FARREL Cotton Applicator	50
FAURE Cervial Biopsy Forceps	118
FAURE Hysterectomy Forceps	36
FAURE Peritoneal Forceps	37
FEILCHENFELD Splinter Forceps	25
FERGUSSON Bone Holding Forceps	62
FERGUSSON Mouth Gag	89
FERRIS-SMITH Rongeur Forceps	85
Finger Ring Cutter	58
FINOCHIETTO Gall Duct Forceps	34
FINOCHIETTO Needle Holder	52
FISCHER Iris Forceps	76
FOERSTER Sponge Holding Forceps	41
Forceps, Advancement	77
Antrum Punch	85
Approximation	56
Bone Cutting	65
Bone Holding	62-63

Bone Plate Holding	129
Bone Rongeur	64-65
Bone Screw Holding	129
Brain	24
Broncho-Esophagoscopy	95
Broncho	37
Capsular	76
Capsule	108
Cervial Biopsy	117-118
Chalazion	77
Clip Applying	56
Clip Applying & Removing	56
Clip Removing	56
Craniotomy	124
Dissecting	23
Dressing	23-24, 39-40
Ear Dressing	80-81
Ear Polypus	81
Entropium	78
Ethmoid	83-84
Fixation	76
Foreign Body	80
Gall Duct	33-35
Gall Stone	105
Goitre Seizing	97
Haemostatic	26-33
Hysterectomy	35-36 116
Intestinal	98-101
Intestinal Clamp	100-102
Iris	75-76
Kidney Pedicle	34
Kidney Stone	106
Laryngeal Polypus	96
Ligature Carrying	108
Lithotomy	107
Lung Grasping	67-68
Nail Tearing	129
Nasal Cutting	83-84
Nasal Dressing	83
Nasal Polypus	83
Obstetrical	121-123
Forceps, Ovum	126
Pedical Clamp	36
Peritoneal	35-37
Pile	104
Placenta	126-127
Polypus Dressing	40
Prostatic Dressing	107-108
Rectal Biopsy	104
Redressing	86



INDEX

Rongeur	64-65
Scalp Flap	31
Septum	86
Septum Compression	84
Septum Straightening	86
Sequestrum	62
Sinus	39
Splinter	25-26
Sponge Holding	41
Sterlizer	128
Stomach Clamp	101
Strabismus	77
Suture	168
Swab Holding	76
Thumb Dressing	23
Tissue	23-25, 30, 76, 98-99
Tongue	92
Tonsil	37
Tonsil Haemostatic	93
Tonsil Holding	93
Tonsil Punch	94
Trachael Dilating	96
Trachoma	78
Urethral Foreign Body	108
Uterine Elevating	117
Uterine Polypus	117
Uterine Tenaculum	114
Uterine Vulsellum	115-116
Utility	128
FORD Chestpieces	56
FORD Stethoscope	8
FORD BOWLES Stethoscope	8
Foreign Body Needle	72
FRAENKEL Laryngeal Forceps	95
FRANCKE Blood Lancets	5
FRAZIER Brain Suction Tube	69
FRAZIER NERVE Hook	69
FREER Chisel	87
FREER Gouge	87
FREER Hook	86
FREER Muscous Knife	86
FREER Elevator	87
FRENCH Pattern Dressing Forceps	39
FRIEDMANN Vaginal Retractor	111
FRITSCH Retractor	47
FUCHS Capsular Forceps	76
FULLER Tracheotomy Tube	96

“G”

GABRIEL Rectal Speculum	103
GALABIN Uterine Sound	113
GELPI Retractor	48
GIERTZ-STILLE Rib Shear	66
GILLIES HOOK	97
Needle Holder	53
Tissue Forceps	24
GOODELL Uterine Dilator	113
GOSSET Abdominal Retractor	49
Gouges	59
GRAEFE Cataract Knife	71
GRAEFE Cataract Spoon	72
GRAEFE Cystotomes	72
GRAEFE Eye Specula	70
GRAEFE Fixation Forceps	76
GRAEFE Fixation Hook	72
GRAEFE Hook	72
GRAEFE Iris Forceps	75
GRAEFE Strabismus Hook	73
GRAHAM Nerve Dura Hook	69
GRAVES Vaginal Specula	109
GRAY Gall Duct Forceps	35
GREEN—ARMYTAGE Uterine Haemostatic Forceps	127
GREY-TURNER Haemostatic Forceps	29
GROSS Dressing Forceps	39-40
GROSS Ear Curette & Hook	79
GRUBER Ear Specula	79
GUY Tongue Forceps	92
GUYON Kidney Pedicle Forceps	34

“H”

HAIG-FERGUSON Obstetrical Forceps	123
HAJEK Nazal Cutting Forceps	84
HAJEK-KOFLER Sphenoid Punch	85
HALSTEAD Mosquito Forceps	27,32
HALSTEAD Needle Holder	54
Hammers, Percussion	7
Handle, Laryngeal Mirror	95
HANK Uterine Dilators	112
HARRINGTON Retractor	43
HARRINGTON-ROCHESTER Tenaculum Forceps	68
HARRISON Sterlizer Forceps	128
HARTMANN Antrum Cannula	87
HARTMANN Bone Rongeur Forceps	65
HARTMANN Ear Dressing Forceps	80
HARTMANN Ear Polypus Forceps	81



INDEX

KRAUSE Ear Snare	80	LONDON HOSPITAL Sterlizer Forceps	128
KRAUSE Nazal Snare	83	LOVELACE Lung Grasping Forceps	68
KRAUSE-VOSS Ear Snare	83	LOWER Gall Duct Forceps	34
KRISTELLER Vaginal Specula	110	LUC Ethmoid Forceps	83-84
KROENLEIN Haemostatic Forceps	29	LUC Nazal Cutting Forceps	83-84
“L”			
LABORDE Trachael Dilating Forceps	96	LUCAE Ear Dressing Forceps	80
LACK Tongue Depressors	91	LUCAE Eustachian Catheter	79
LA-FORCE Adenotomes	88	LUCAE Tympanum Perforator	79
LAHEY Gall Duct Forceps	34	LUER Bone Rongeur Forceps	64
LAHEY Goitre Seizing Forceps	97	LUER Pile Clamp	104
LAMBOTTE Bone Holding Forceps	63	LYNCH Tonsil Knife	93
Laminectomy Rongeur	69	“M”	
LAMPBERT Chalazion Forceps	77	MACPHAIL Needle Holder	54
LANDAU Vaginal Retractor	111	MAGILL Catheter Introducing Forceps	9
LANE Bone Holding Forceps	63	MAIER Polypus Dressing Forceps	40
LANE Bone Plate Holding Forceps	129	MAINGOT Hysterectomy Forceps	116
LANE Bone Screw Holding Forceps	129	Mallets	60
LANE Stomach Clamp Forceps	101-102	MARTIN Pelvimeter	125
LANE Tissue Forceps	25, 30, 98-99	MARTIN Uterine Sound	113
LANGE-HOHMANN Bone Lever	62	MASON Mouth Gag	89
LANGENBECK Amputation Knife	15	MASSON Needle Holder	52
LANGENBECK Bone Holding Forceps	62	MASTIN Muscular Clamp	97
LANGENBECK Elevator	61	MATHIEU Needle Holders	53
LANGENBECK Needle Holder	53	MATHIEU Rectal Speculum	103
LANGENBECK Pile Clamp	104	MATHIEU Tongue Forceps	92
LANGENBACK Raspatory	61	MATHIEU Urethral Foreign Body Forceps	108
LANGENBECK Retractor	45	MAYO Dissecting Scissors	17
Laryngoscopes	9	MAYO Gall Stone Probe	106
LEGUEU Bladder Retractor	108	MAYO Gall Stone Scoop	105
LEKSELL-STILLE Bone Rongeur Forceps	64	MAYO Kidney Pedicle Forceps	34
LEMPERT Bone Rongeur Forceps	64	MAYO Safety Pin	50
Lever, Bone	62	MAYO Tongue Depressor	31
LEWKOWITZ Lithotomy Forceps	107	MAYO Towel Clamps	38
LEXER Operating Scissors	18	MAYO-ADAMS Retractor	49
LICHWITZ Antrum Trocar	11	MAYO-BLAKE Gall Stone Forceps	105
LIGHTWEIGHT Chestpiece	6	MAYO-GUYON Kidney Pedicle Forceps	34
LIGHTWEIGHT Stethoscope	8	MAYO-HEGAR Needle Holder	51
LISTER Bandage Scissors	57	MAYO-STILLE Operating Scissors	17
LISTER Bougies	107	McDONALD Dissector	50
LISTER Sinus Forceps	39	McINDOE Dissecting Forceps	24
LISTON Amputation Knife	15	McINDOE preparation Scissors	18
LISTON Bone Cutting Forceps	65	McINTOSH Laryngoscopes	9
LISTON-KEY Bone Cutting Forceps	65	McKENZIE Brain Suture Clamp	69
LITTAUER Stitch Scissors	19	McLEAN Obstetrical Forceps	122
LITTLEWOOD Tissue Forceps	98	McLEAN-TUCKER Obstetrical Forceps	122
LOCKWOOD Tissue Forceps	98	MELLINGER Eye Specula	70
LOCKWOOD-ALLIS Tissue Forceps	98	MERCIER Metal Catheter	106
		METZENBAUM Needle Holder	52
		METZENBAUM Operating Scissors	18



INDEX

METZENBAUM-Nelson Operating Scissors	18
MEYERDING Retractor	45,47
MEYHOEFER Chalazion Curette	74
MEYHOEFER Spoon	73
MICHEL Clip Applying	56
MICHEL Clip Applying & Removing Forceps	56
MICHEL Clip Removing Forceps	56
MIKULICZ Intestinal Clamp Forceps	101
MIKULICZ Peritoneal Forceps	37
MIKULICZ Retractor	47
MILLIN Capsule Forceps	108
MILLIN Bladder Neck Retractor	108
MILLIN Bladder Retractor	108
MILLIN Ligature Carrying Forceps	108
MILLIN Prostatic Lobe Holding Forceps	108
MILLIN Suction Tube	108
MILNE-MURRAY Obstetrical Forceps	124
MIXTER GALL Duct Forceps	33
MOLT Mouth Gag	89
Mouth Gags	89
MORRIS Retractors	89
MOYNIHAN Hysterectomy Forceps	36
MOYNIHAN Towel Clamps	36
MULLER Eye Specula	70
MUSEUX Vulsellum Forceps	115-116
MYLES Curettes	86
MYLES Nazal Cutting Forceps	84

“N”

NAEGELE Obstetrical Forceps	122
NAEGELE Perforator	125
Nail Nipper	129
Scissors	129
NAUTON-MORGAN Protoscope	103
Needle Aneurism	50
Cataract	72
Discision	72
Foreign Body	72
& Gouge	74
Holders	51-54
Ligature	54
& Spud	74
Suture	55
Tonsil	93
NEGUS Laryngoscopes	9
NEGUS Tonsil Forceps	37
NELSON Superapubic Trocar	10
NOTO Uterine Polypus Forceps	117
NOVAK Biopsy Curette	120

NOYES Iris Scissors	77
NUSSBAUM Intestinal Clamp Forceps	101

“O”

OCHSNER Gall Bladder Trocar	11
OLDBERG Laminectomy Rongeur	69
OLSEN HEGAR Needle Holder	53
Osteotomes	59
Otoscope Set	5
OVERHOLT-GEISSENDORFER Haemostatic Forceps	33

“P”

PARKER Retractor	42
PAYR Intestinal Crushing Clamp	102
PEAN Haemostatic Forceps	28
PEET Splinter Forceps	26
Pelvimeter	125-126
PENNINGTON Haemostatic Forceps	31
PERCY Retractor	64
PERCY Tissue Forceps	99
PHANEUF Peritoneal Forceps	35
PIMERROY Ear Syringe	79
PINARD Stethoscope	6
PIPER Obstetrical Forceps	122
Plaster, Cast Breaker	58
Knife	58
Spatula	50
Spreader	58
POOLE Suction Tube	11
POTTS-SMITH Dura Dressing Forceps	23
POTTS-SMITH Tissue Forceps	24
PORRIER Tissue Forceps	99
POZZI Uterine Tenaculum Forceps	114
PRATT Haemostatic Forceps	31
PRATT Vulsellum Forceps	116
PRICE-THOMAS Bronchus Clamp	67
Probe General	50
Proctoscopes	103
PROVIDENCE HOSPITAL Haemostatic Forceps	28
PROVIS Fallopian Tube	127

“Q”

QUIRE Foreign Body Forceps	80
----------------------------	----

“R”



INDEX

RADOLF Nail Tearing Forceps	129	SAUERBRUCH Bone Rongeur Forceps	65
RALKS Splinter Forceps	26	SAUERBRUCH Retractor	47
RAMPLEY Sponge Holding Forceps	41	Saws, Amputation	59
RAMSAY Tissue Forceps	25	Bone	59
RANDALL Biopsy Curette	120	Nazal	88
RANDALL Kidney Stone Forceps	106	Plaster	58
RANKIN Intestinal Crushing Clamp	102	Postmortem	59
RANKIN-CRILE Haemostatic Forceps	28	SAWTELL Tonsil Haemostatic Forceps	93
RANKIN-KELLY Haemostatic Forceps	27	Scalpel Handle	12
Raspatories	61	Operating	12-14
Razor	15	SCHAEDEL Towel Clamps	38
RECAMIER Uterine Curettes	119	SCHIMMELBUSCH Face Mask	9
REINER Plaster Knife	58	SCHMIDT-RIMPLEX Fixation Forceps	76
Retractors, Abdominal	49	SCHMIDT Tonsil Haemostatic Forceps	93
Appendectomy	49	SCHOEMAKER GOITRE Scissors	97
Bladder	108	SCHOEMAKER-LOTH Ligature Scissors	20
General Operating	42-48	SCHROEDER Uterine Tenaculum Forceps	114
Tonsil	93	SCHROEDER Vulsilum Forceps	115
Vaginal	111	SCHUBERT Cervial Biopsy Forceps	117
REVERDIN Suture Needle	55	-CISSORS, Bandage	57
RHEINSTATER Uterine Curettes	120	Cataract	78
RICHARDSON Retractor	46	Corneal	78
RICHARDSON-EASTMAN Retractor	46	Cuticle	129
RICHTER-HEATH Clip Removing Forceps	56	Dental	22
RIGBY Abdominal Retractor	49	Dissecting	21
ROBERTS Haemostatic Forceps	37	Enterotomy	22
ROCHESTER-CARMALT Haemostatic Forceps	30	Episiotomy	20
ROCHESTER-MAYO Needle Holder	54	Gauge	57
ROCHESTER-OCHSNER Haemostatic Forceps	30	Goite	97
ROCHESTER-PEAN Haemostatic Forceps	28	Incision	7
ROLLET Chisel	73	Iris	22
ROLLET Lacrimal Sac Hook	72	Ligature	20
ROSER-KONIG Mouth Gags	89	Nail	129
ROUX Retractor	42	Nazal	19
RUMMEL Haemostatic Forceps	32	Neurosurgical	18
RUSKIN Bone Rougeur Forceps	64	Operating	17-18
RUSKIN LISTON Bone Cutting Forceps	65	Stitch	19
RUSSIAN Tissue Forceps	25	Strabismus	22
		Suture	19
		Tenotomy	22
		Tonsil	18-19
		Umbilical	20
		Uterine	21
		Wire Cutting	20
		Scoops, Gall Duct	105
		SCUDDER Stomach Clamp Forceps	100
		SEMB Bone Holding Forceps	62
		SEMB Raspatory	61
		SEMKEN Dressing Forceps	24

“S”

SACHS Nerve Dura Hook	69
SAENGER Ovum Forceps	127
ST. CLAIR THOMSON Adenoid Curettes	88
ST. CLAIR Nazal Specula	82
SAROT Bronchus Forceps	67
SAROT Needle Holder	52
SATINSKY Anastomosis Clamps	67
SATTERLEE Amputation Saw	59



INDEX

TROELTSCH Nazal Dressing Forcep	83
TROELTSCH Tympanum Perforator	79
TROUSSEAU Tracheal Dilating Forceps	96
Tube Tracheotomy	96
TUFFIER Rib Spreader	66

“U”

UNIVERSAL Trocar	10
UNIVERSAL Wire Cutting Scissors	20
UNNA Comedone Extractor	97
U.S.A. Umbilical Scissors	20
U.S. Army Pattern Retractor	42
Uterine Curettes	119-120
Uterine Depressors	113
Uterine Sounds	113
Utility Forceps	128

“V”

VAN-BUREN Sequestrum Forceps	62
VAN-DOREN Cervial Biopsy Forceps	118
VIENNA Nazal Specula	82
VOLKMANN Bone Spoon	60
VOLKMAN Retractor	44
VOLTOLINI Nazal Specula	82

“W”

WACHENFELDT Clip Appling Forceps	56
WALSHAM Redressing Forceps	86
WALSHAM Septum Straightening Forceps	86
WALTER-CARMALT Splinter Forceps	26
WALTON Foreign Body Spud	73
WANGENSTEEN Ductus Clamp	67
WANGENSTEEN Needle Holder	52
WARTENBURG Pin Wheel	7
WEBER Lens Scoop	72
WESTER Needle Holder	51
WECKER Iris Scissors	78
WECKER Iris Spatula	73
WEIL Nazal Cutting Forceps	84
WEITLANER Retractor	48
WELLS Enuclation Scoop	73
WERTHEIM Hysterectomy Clamp	36
WERTHEIM Hysterectomy Forceps	37
WERTHEIM Peritoneal Forceps	37
WERTHEIM CULLEN Hysterectomy	36
WEST Retractor	48
WESTCOTT Strabismus Scissors	22

WHEELER Cyclodialysis Spatula	74
WHEELHOUSE Staff	107
WHITE Tonsil Seizing Forceps	93
WHITEHEAD Mouth Gags	90
WIEDER Tongue Depressors	91
WIEDER Tonsil Retractor	93
WILDE Ear Dressing Forceps	80
WILDE Ear Polypus Snare	80
WILDE Nazal Snare	80
WILDER Lacrimal Dilator	74
WILLET-MARTEL Scalp Flap Forceps	31
WILLET Placenta Forceps	127
WILLIGER Elevator	61
WILLIGER Mallet	60
WINTER Cranioclast & Cephalotribe	124
WINTER Placenta Forceps	126
WINTER Cervical Biopsy Forceps	118
WOAKES Eustachian Catheter	79
WOLFF Plaster Cast Breaker	58
WORTH Advancement Forceps	77
WRIGHT Needle Holder	51
WRIGLEY Obstetrical Forceps	121
WYLIE Uterine Dilator	113

“Y”

YANKAUER Ear Polypus Forceps	80
YANKAUER Face Mask	9
YANKAUER Nazal Specula	82
YANKAUER Suction Tube	11
YANKAUER Tonsil Scissors	19
YEOMAN Rectal Biopsy Punch Forceps	104
YOUNG Prostatic Lobe Holding Forceps	107
YOUNG Tongue Depressors	92
YOUNG-BOOMRANG Needle Holder	55

“Z”

ZIEGLER Iris Knife	72
ZWEIFEL Uterine Curette	119



SURGICAL INSTRUMENTS

DIAGNOSTICS

DIAGNOSTIC SETS

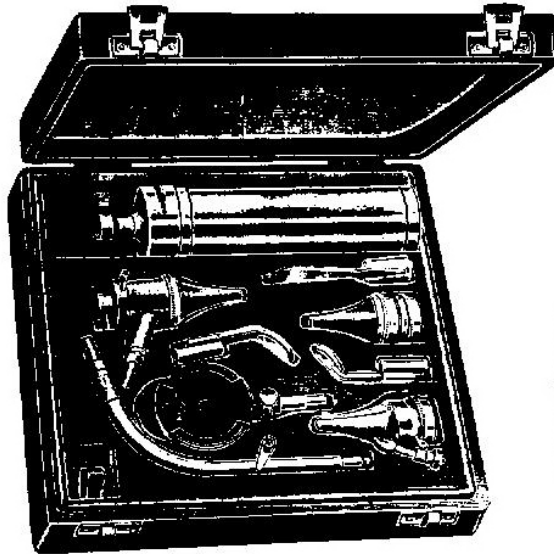

UNIVERSAL SET
1-100

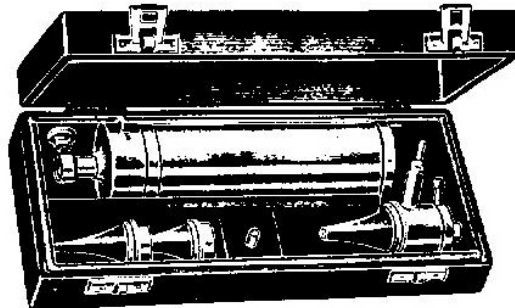

OTOSCOPE SET
1-110

BLOOD LANCETS



FRANCKE
1-120



FRANCKE
1-130

CHEST PIECES

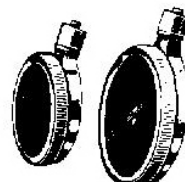

BOWLES
1-140

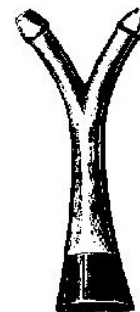

BOWLES
1-150



SURGICAL INSTRUMENTS

DIAGNOSTICS
CHEST PIECES AND STETHOSCOPES

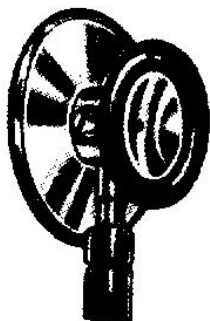

LIGHT WEIGHT
1-160

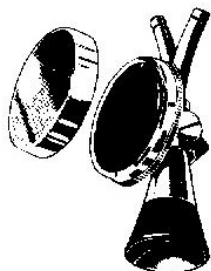

SPRAGUE-BOWLES
1-170

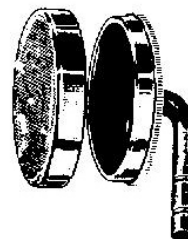

BOWLES
1-180



FORD
1-190



BELL-END
1-200



SPARE RUBBER
1-210



DIAPHARM
1-220

FRAMES

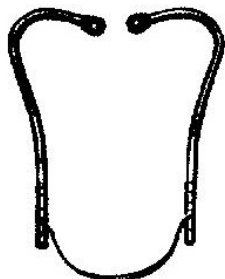

HEAD FRAME
FOR LIGHTWEIGHT
1-230

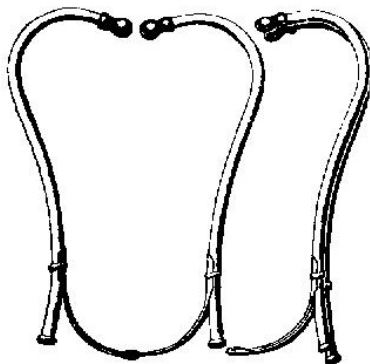

HEAD FRAME
FOR BINURAL
1-240

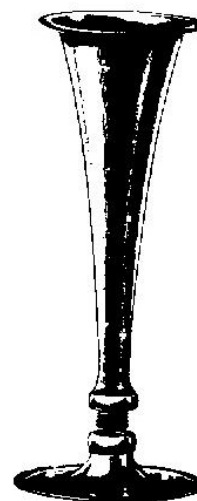

PINARD
1-250 ALUMINIUM
1-260 WOODEN



SURGICAL INSTRUMENTS

**DIAGNOSTICS
STETHOSCOPES**



BOWLES
1-270

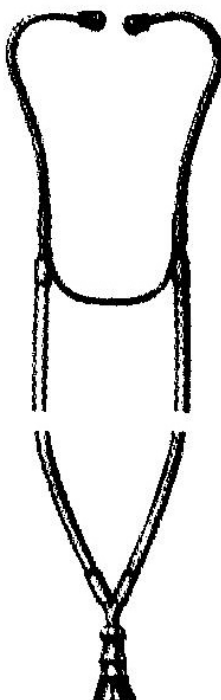

FORD
1-280



FORD-BOWLES
1-290

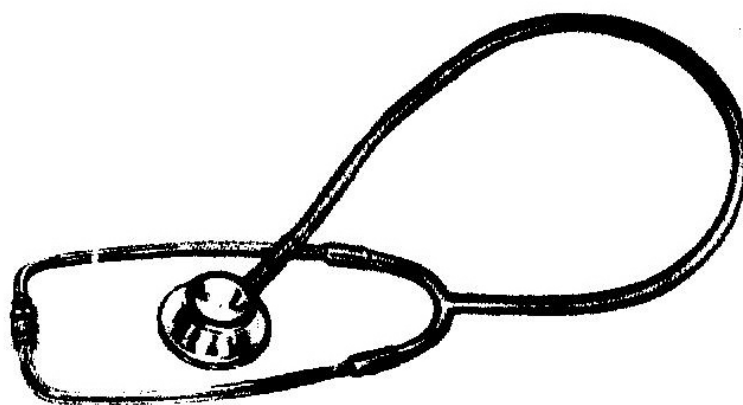

LIGHTWEIGHT
1-300



SURGICAL INSTRUMENTS

DIAGNOSTICS

PERCUSSION HAMMERS



TAYLOR
1-310 19 cm

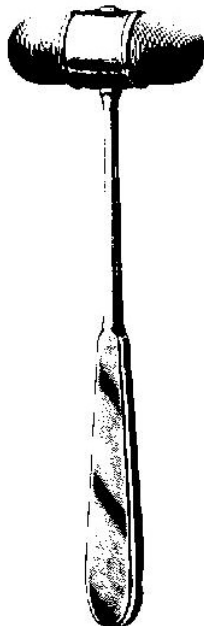

DEJERINE
1-320 20 cm

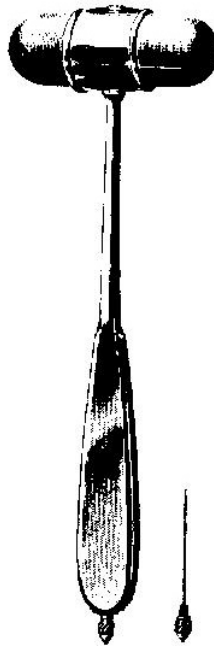

DEJERINE
1-330

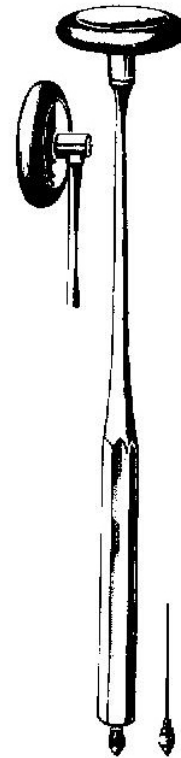

BABINSKY
1-340

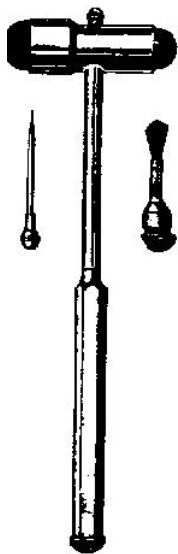

BUCK
1-350 18 cm
8

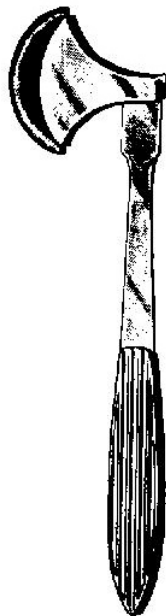

BERLINER
1-360

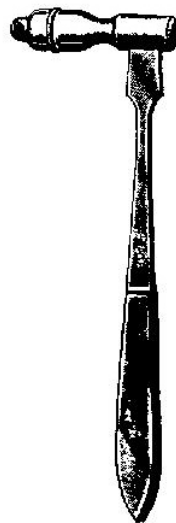

TRAUBE
1-370

PINWHEEL



WARTENBERG
1-380



ANAESTHESIA

INHALERS

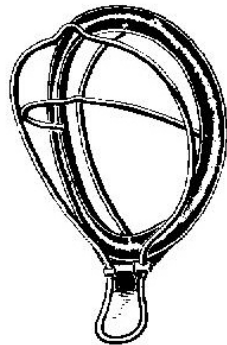

SCHIMMELBUSCH
3-100 ADULT
3-102 CHILD

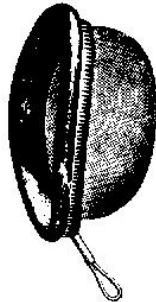

YANKAUER
3-120 ADULT
3-122 CHILD

AIRWAYS



CONNELL
3-130 ADULT
3-132 CHILD

CATHETER INTRODUCING FORCEPS

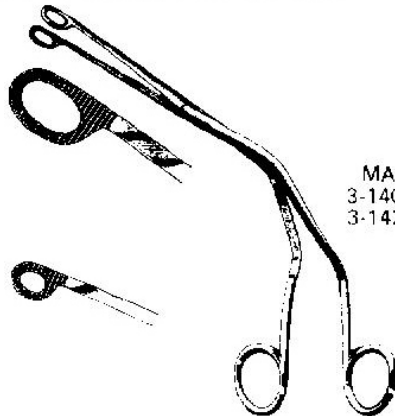

MAGILL
3-140 24 cm
3-142 20 cm

LARYNGOSCOPES

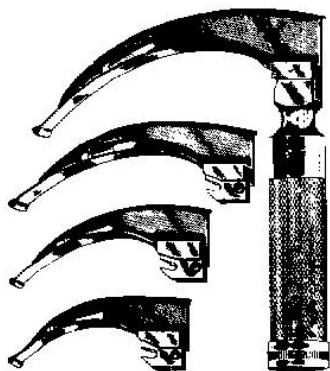

McINTOSH
3-150

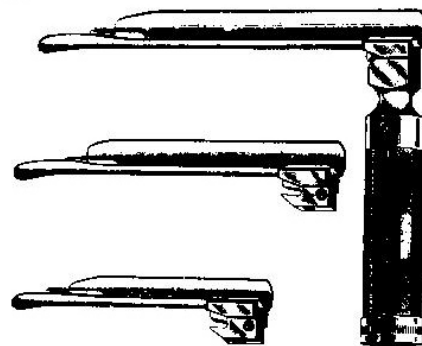

NEGUS
3-160

PUNCTURE
TROCARS ABDOMINAL



6/6 4 1/2 3 1 3/4 mm



UNIVERSAL
5-100 SET OF 4



UNIVERSAL
5-110 SET OF 3



ABDOMINAL

5-120 3 mm	5-130 3 mm	5-140
5-121 3.5mm	5-131 3.5mm	5-141
5-122 4 mm	5-132 4 mm	5-142
5-123 4.5mm	5-133 4.5mm	5-143
5-124 5 mm	5-134 5 mm	5-144
5-125 5.5mm	5-135 5.5mm	5-145
5-126 6 mm	5-136 6 mm	5-146



NELSON
5-150 25 Fg.
5-152 30 Fg.
5-154 33 Fg.
5-156 35 Fg.

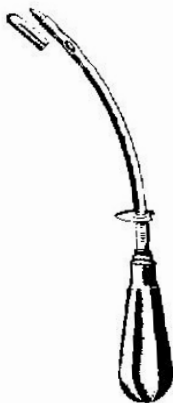

FLEURANT
5-160

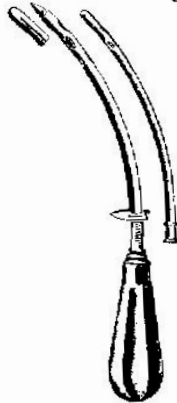

FLEURANT
5-170



HYDROCELE
5-180 8 Fg.
5-182 9 Fg.
5-184 10 Fg.



ACITES
5-190 16 Fg.
5-192 21 Fg.



SURGICAL INSTRUMENTS

**PUNCTURE
TROCARS ABDOMINAL**

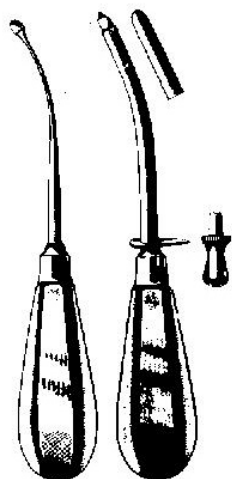

KRAUSE
5-200 5.5mm



LICHTWITZ
5-210 1.75mm



OCHSNER
5-220 10Fg.
5-221 12Fg.
5-222 14Fg.
5-223 16Fg.
5-224 18Fg.
5-225 20Fg.

**ASPIRATION
SUCTION TUBES**



POOLE
5-230 30 Fg.



POOLE
5-240 30Fg.



YANKAUER
5-250

GENERAL INSTRUMENTS

HANDLES

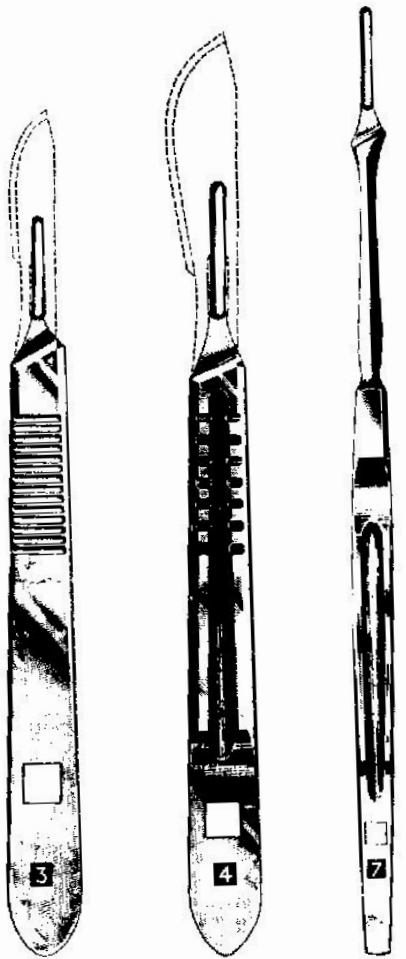

7-103

7-104

7-107

SCALPELS

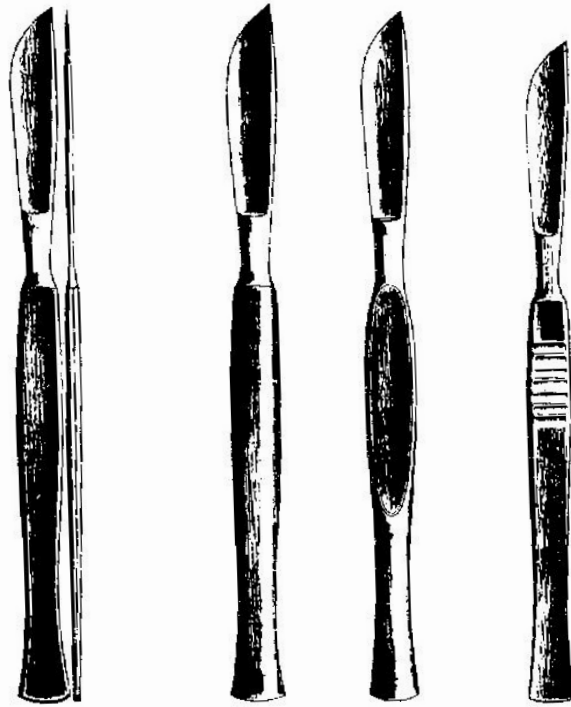

7-110
Fig. 1 to 18

7-120
Fig. 1 to 18

7-130
Fig. 1 to 18

7-140
Fig. 1 to 18

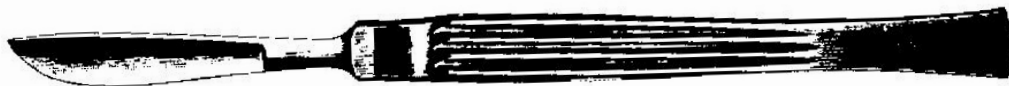

7-150
Fig. 1 to 18



GENERAL INSTRUMENTS
SCALPELS

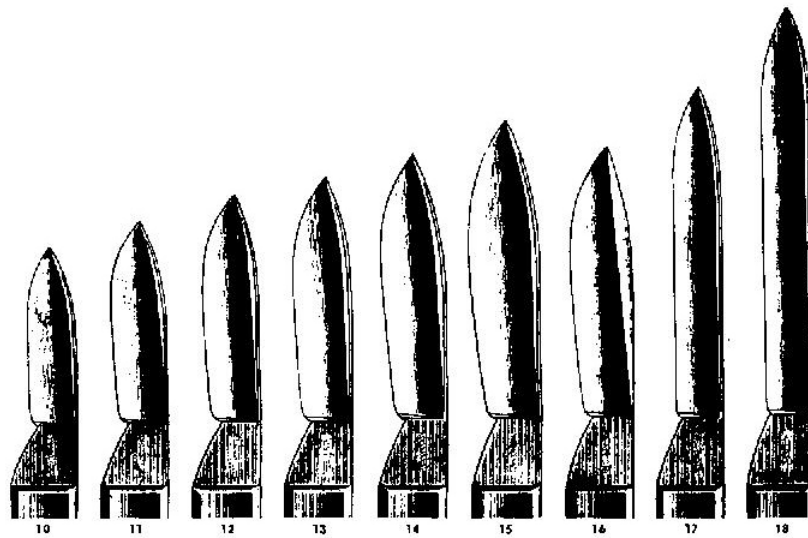
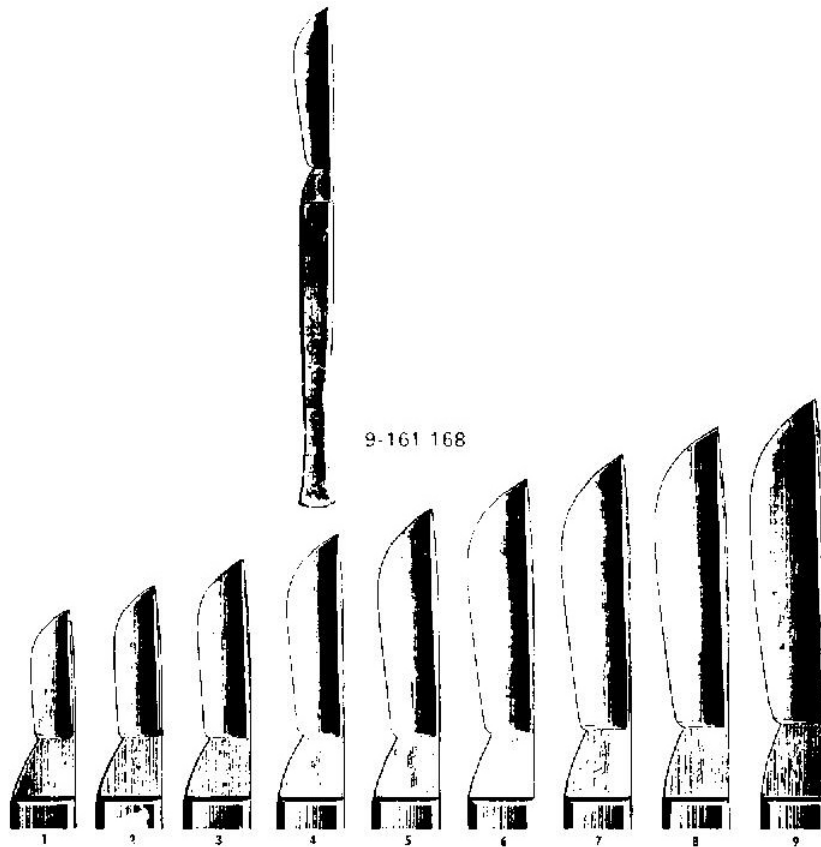

GENERAL INSTRUMENTS

SCALPELS

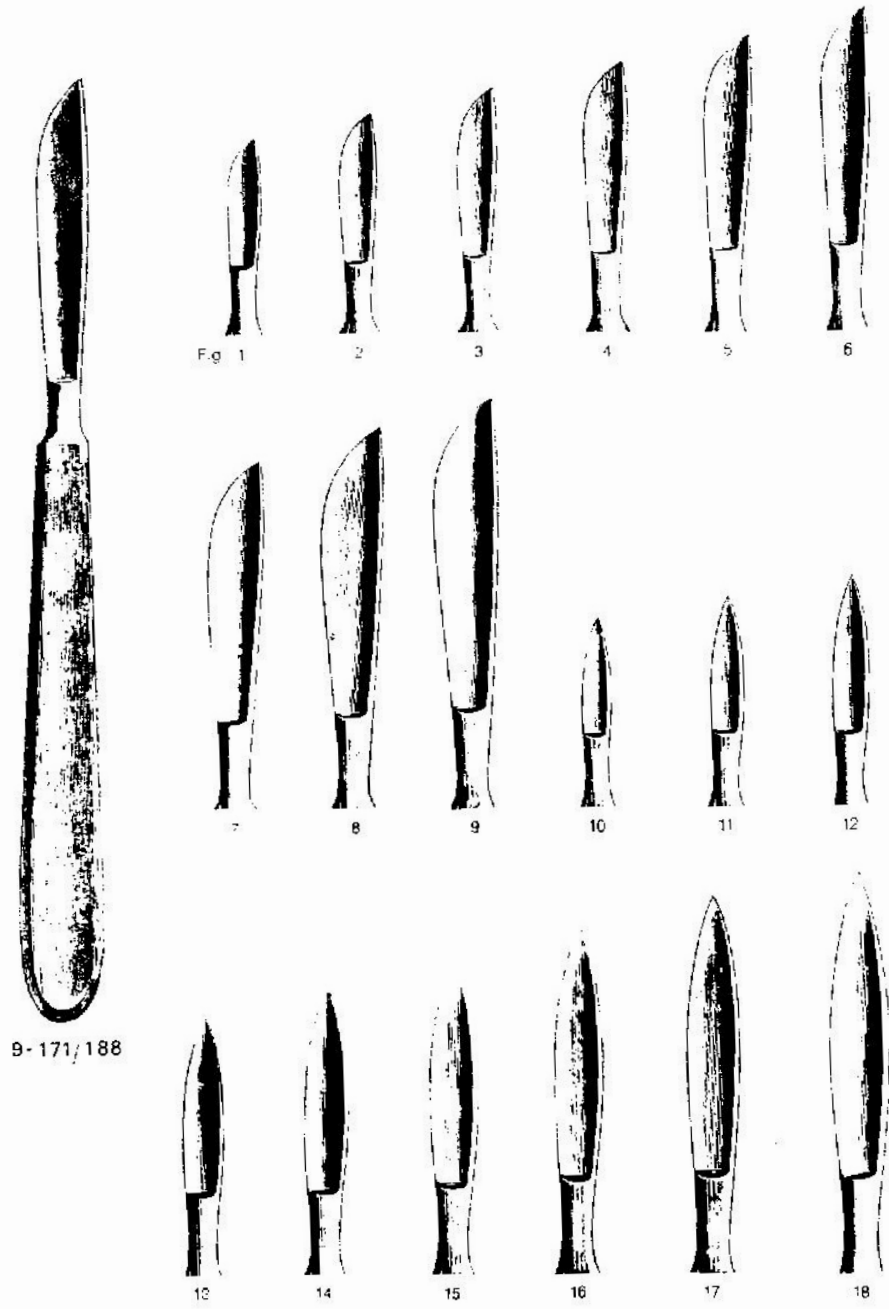



GENERAL INSTRUMENTS

KNIVES



LANGENBECK AMPUTATION
9-190 Blade 12cm

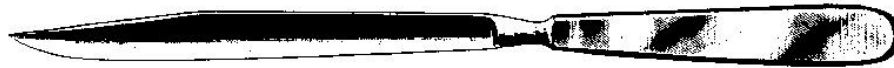

LISTON AMPUTATION
9-200 Blade 17, 20cm

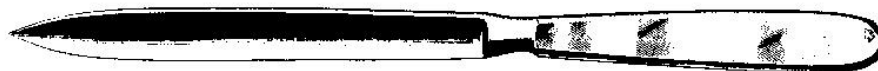

AMPUTATION
9-210
Blade 13, 16, 19, 22cm

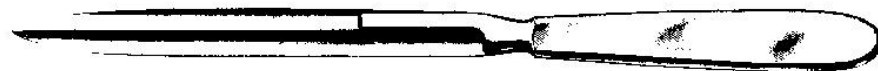

CATLIN
9-220
Blade 16, 19, 22cm



BRAIN
9-230
Blade 20, 22cm

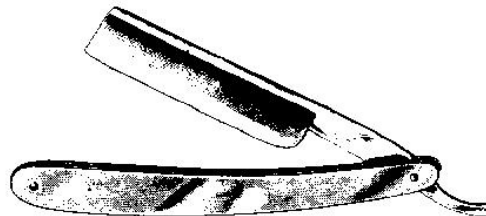

RAZOR
9-240



GENERAL INSTRUMENTS
DISSECTING SETS

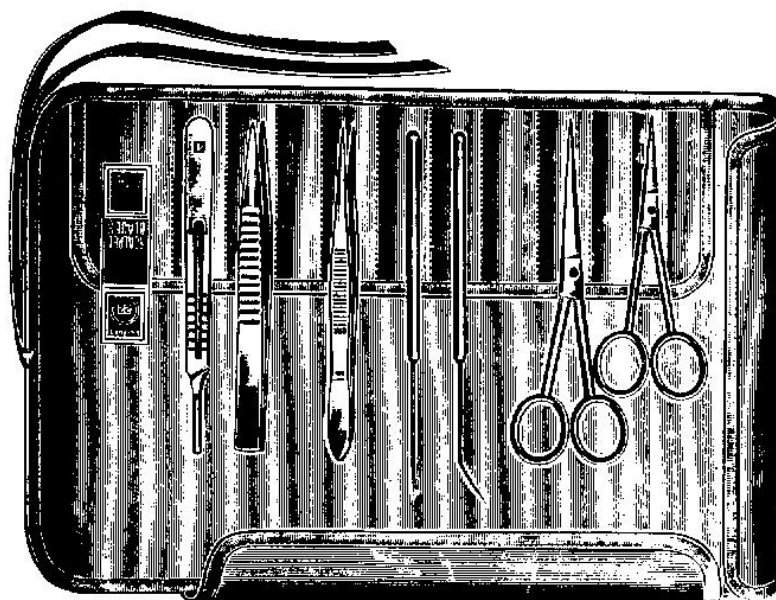

11-100

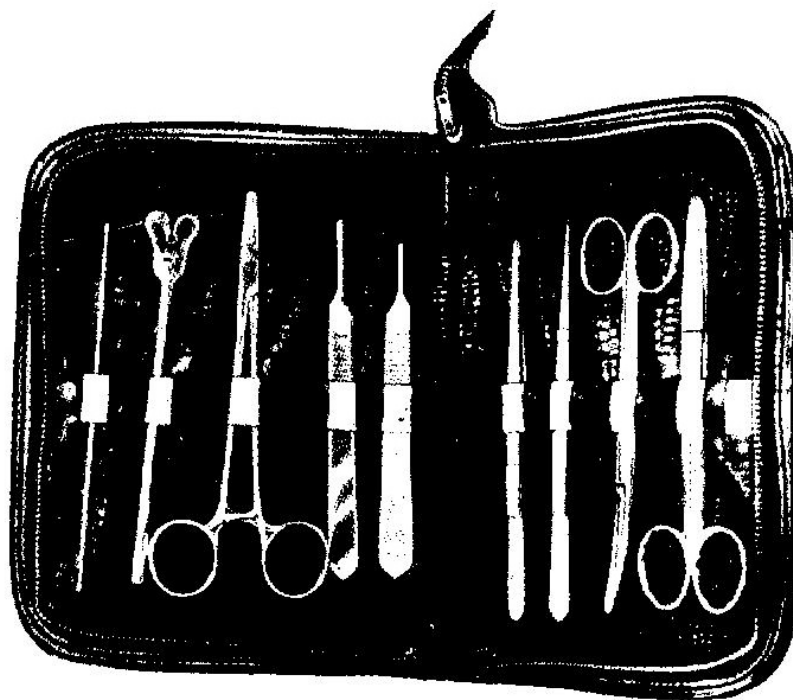

11-120



SURGICAL INSTRUMENTS

GENERAL INSTRUMENTS

OPERATING SCISSORS

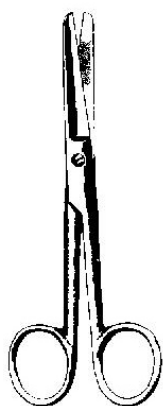

OPERATING

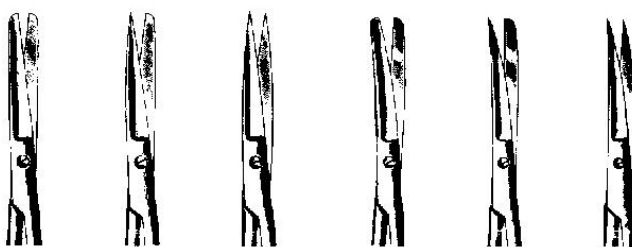

13-100	13cm	13-110	13cm	13-120	13-130	13cm	13-140	13cm	13-150
13-102	14cm	13-112	14cm	13-122	13-132	14cm	13-142	14cm	13-152
13-104	15cm	13-114	15cm	13-124	13-134	15cm	13-144	15cm	13-154
13-106	17.5cm	13-116	17.5cm	13-126	13-136	17.5cm	13-146	17.5cm	13-156
13-108	20cm	13-118	20cm	13-128	13-138	20cm	13-148	20cm	13-158

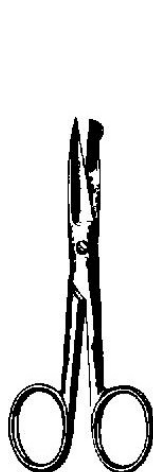

INCISION
13-160 13cm
13-162 14cm

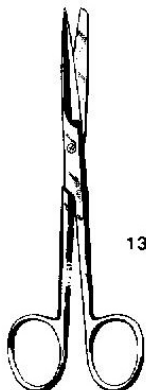

DEAVER
13-170 14cm



13-172 14cm

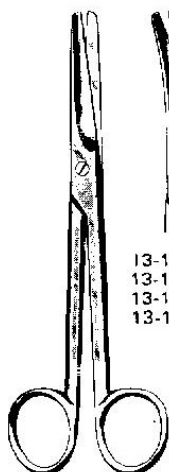

MAYO
13-180 14cm
13-182 15cm
13-184 17cm
13-186 23cm



13-190 14cm
13-192 15cm
13-194 17cm
13-196 23cm

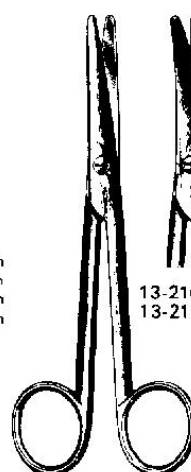

MAYO STILLE
13-200 15cm
13-202 17cm



13-210 15cm
13-212 17cm



**GENERAL INSTRUMENTS
OPERATING SCISSORS**

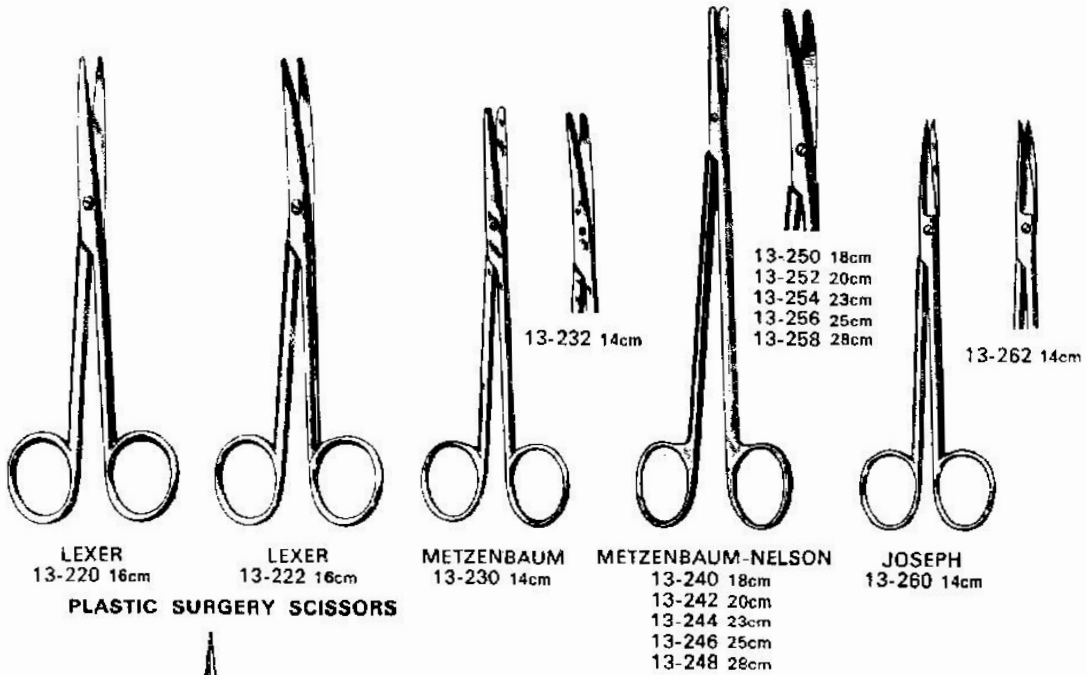

NEURO SCISSORS

TONSIL SCISSORS

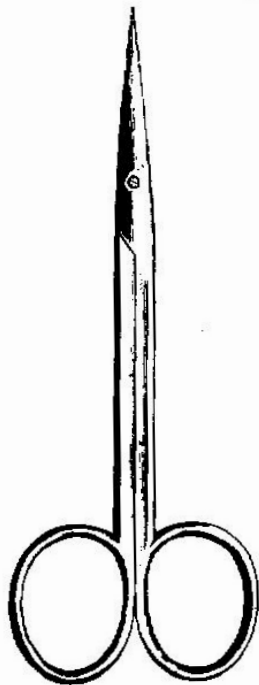

KILNER
13-270 12cm

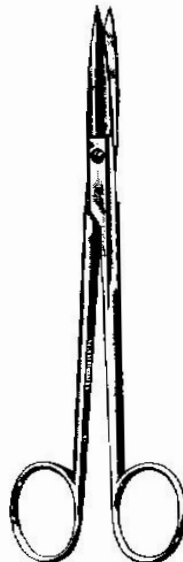

McINDOE
13-280 22cm

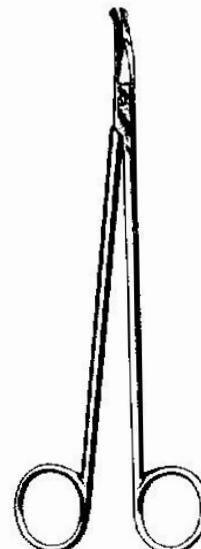

STRULLY
13-290 19cm

GENERAL INSTRUMENTS

TONSIL SCISSORS

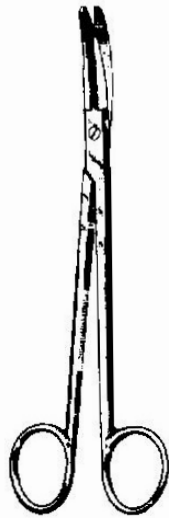

YANKAUER
13-300 17.5cm

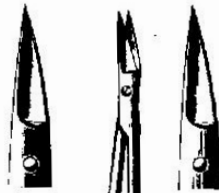

13-312 17cm

DEAN
13-310 17cm

NAZAL SCISSORS

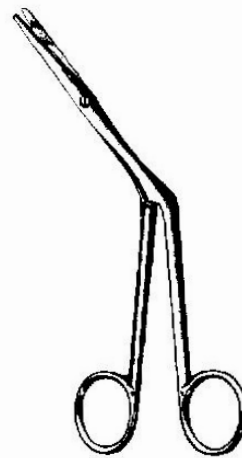

HEYMAN
13-320 18cm

NAZAL SCISSORS

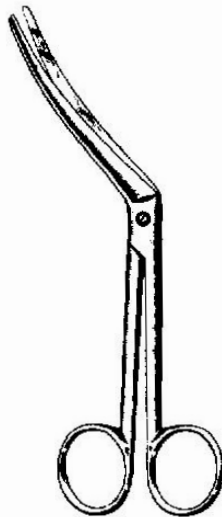

BECKMAN
13-330 19cm

LIGATURE SCISSORS

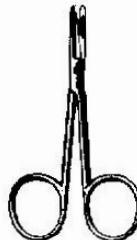

SPENCER
13-340 9cm

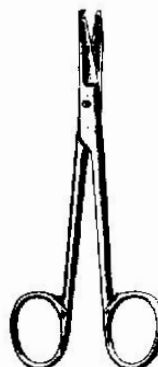

SPENCER
13-350 13cm

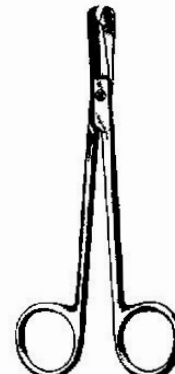

LITTAUER
13-360 14cm



SURGICAL INSTRUMENTS

GENERAL INSTRUMENTS

LIGATURE & WIRE SCISSORS



HEATH
13-370 15cm

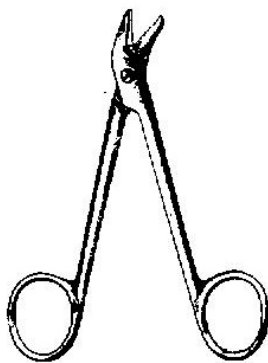

UNIVERSAL
13-380 12cm

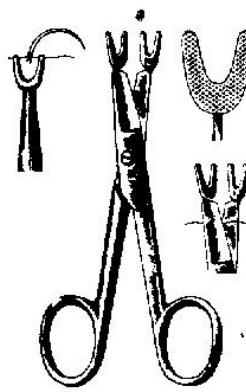

SCHOEMAKER
13-390 14.5cm

UMBILICAL SCISSORS

EPISITOMY SCISSORS

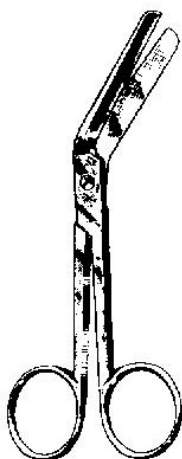

BRAUN-STADLER
13-400 14.5cm
13-402 22 cm

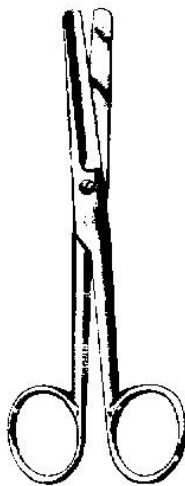

BUSCH
13-410 16cm

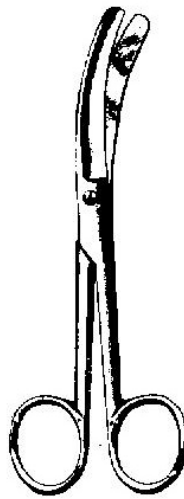

BUSCH
13-420 16cm



U.S.A. PATT.
13-430 10.5cm
13-432 12.5cm

GENERAL INSTRUMENTS

DISSECTING SCISSORS

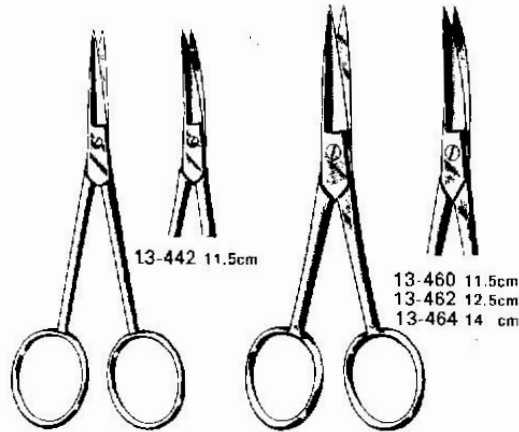

DISSECTING
13-440 11.5cm

DISSECTING
13-450 11.5cm
13-452 12.5cm
13-454 14 cm

UTERINE SCISSORS

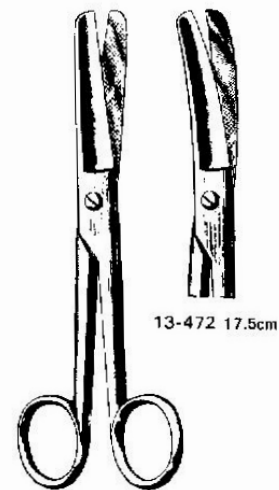

DOYEN
13-470 17.5cm

UTERINE SCISSORS

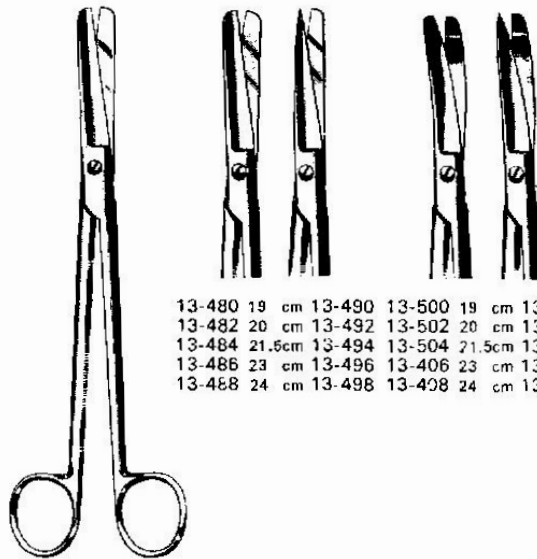

SIM'S

- | | | | |
|---------------|---------------|---------------|---------------|
| 13-480 19 cm | 13-490 19 cm | 13-500 19 cm | 13-510 19 cm |
| 13-482 20 cm | 13-492 20 cm | 13-502 20 cm | 13-512 20 cm |
| 13-484 21.5cm | 13-494 21.5cm | 13-504 21.5cm | 13-514 21.5cm |
| 13-486 23 cm | 13-496 23 cm | 13-406 23 cm | 13-516 23 cm |
| 13-488 24 cm | 13-498 24 cm | 13-408 24 cm | 13-518 24 cm |

FISTULA SCISSORS

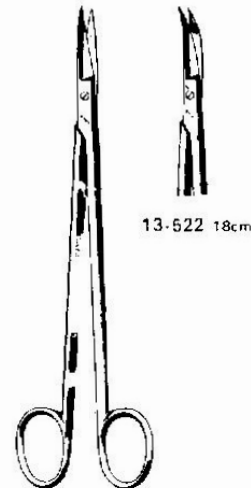

KELLY
13-520 18cm



SURGICAL INSTRUMENTS

GENERAL INSTRUMENTS

EYE SCISSORS

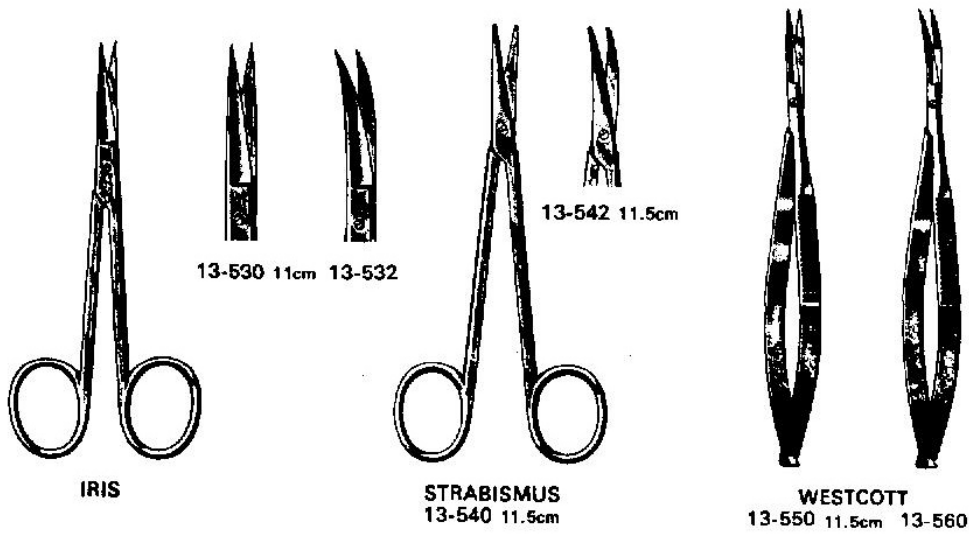

TENOTOMY SCISSORS

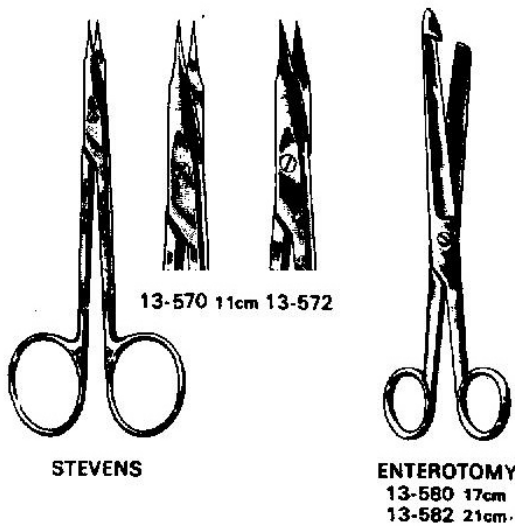

DENTAL SCISSORS

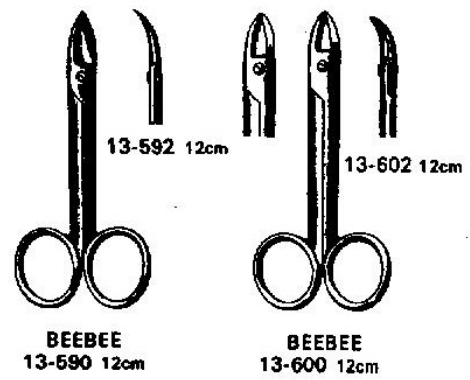



GENERAL INSTRUMENTS
DRESSING AND TISSUE FORCEPS



ENGLISH T.O.E.
15-100 10 cm
15-102 12.5cm
15-104 16 cm
15-106 18 cm
15-108 20 cm



ENGLISH B/END
15-110 12.5cm
15-112 16 cm
15-114 18 cm



THUMB
15-120 11.5cm
15-121 12.5cm
15-122 14 cm
15-123 16 cm
15-124 20 cm
15-125 25 cm
15-126 30 cm



TREVE
15-130 12.5cm
15-132 16 cm
15-134 18 cm



1:2 TISSUE
15-140 11.5cm
15-141 12.5cm
15-142 14 cm
15-143 16 cm
15-144 20 cm
15-145 25 cm
15-146 30 cm



2:3 TISSUE
15-150 12.5cm
15-152 14 cm
15-154 16 cm
15-156 18 cm
15-158 20 cm



3:4 TISSUE
15-160 12.5cm
15-162 14 cm
15-164 16 cm



4:5 TISSUE
15-170 12.5cm
15-172 14 cm
15-174 16 cm



BROPHY
15-180 20cm



BROPHY
15-190 20cm



POTTS-SMITH
15-200 18 cm
15-202 21 cm
15-204 25 cm



15-210
15-212
15-214



GENERAL INSTRUMENTS
DRESSING AND TISSUE FORCEPS



CUSHING
15-220 17.5cm



CUSHING
15-230 17.5cm



1:2
BROPHY
15-240 20cm



1:2
BROPHY
15-250 20 cm



1:2
POTTS-SMITH
15-260
15-262
15-264

18 cm
21 cm
25 cm



1:2
15-270
15-272
15-274



1:2
CUSHING
15-280 17.5cm



1:2
CUSHING
15-290 17.5cm



ADSON
15-300 12cm



McINDOE
15-310 15cm



SEMKEN
15-320 12.5cm
15-322 15 cm



1:2
ADSON
15-330 12cm



1:2
GILLIS
15-340 15cm

GENERAL INSTRUMENTS

DRESSING & TISSUE FORCEPS

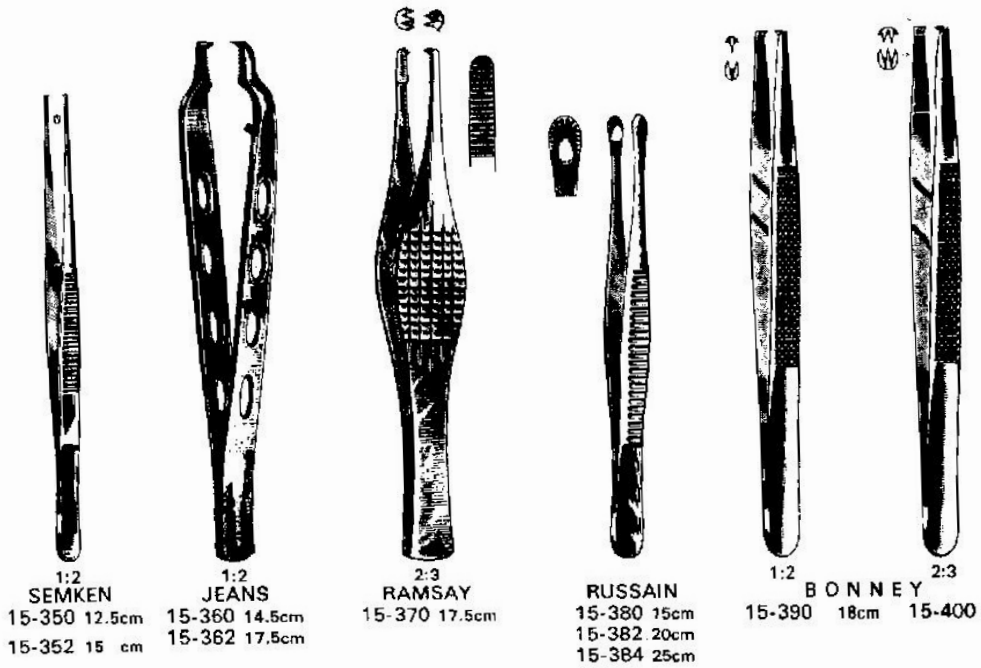

SPLINTER FORCEPS

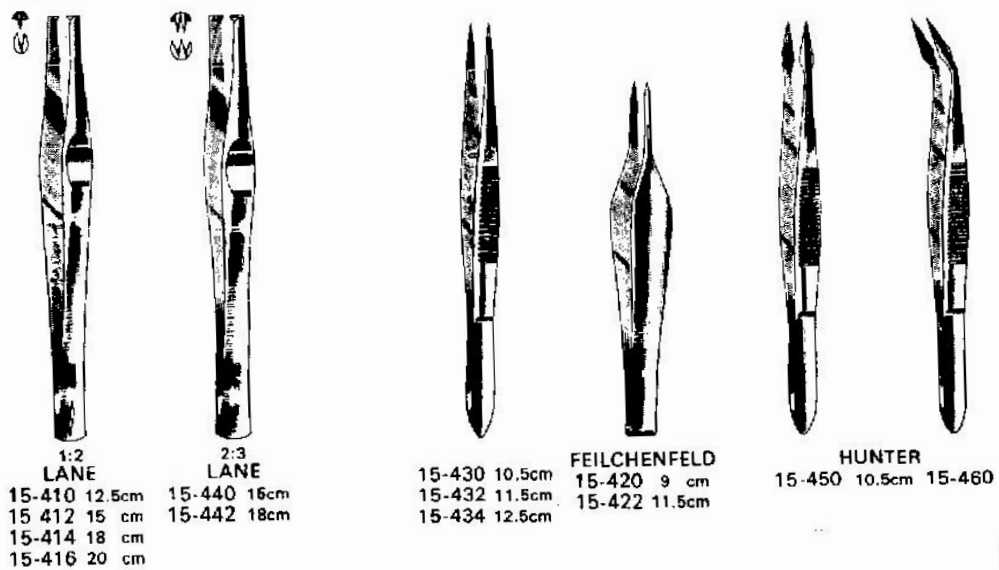

GENERAL INSTRUMENTS

SPLINTER FORCEPS

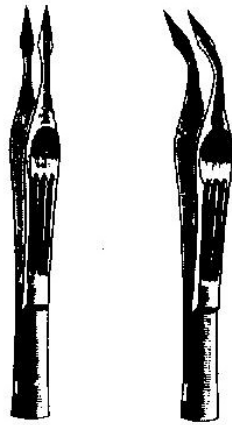

WALTER-CARMALT
15-470 10.5cm 15-480



PEET
15-490 11.5cm

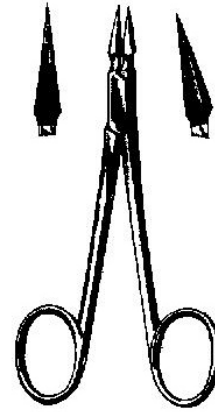

STIEGLITZ
STR 15-500 14cm CUR 15-502

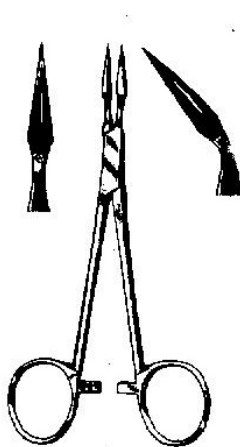

ARTHUR
STR 15-510 14cm CUR 15-512



RALK
15-520 15cm

HAEMOSTATIC FORCEPS

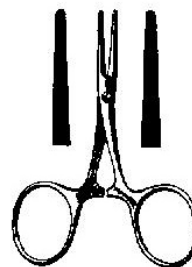

CARREL
17-100 8.5cm

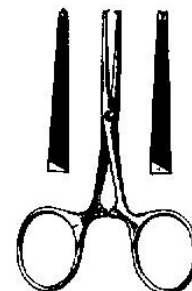

TERRIER
17-110 8.5cm

GENERAL INSTRUMENTS

HAEMOSTATIC FORCEPS

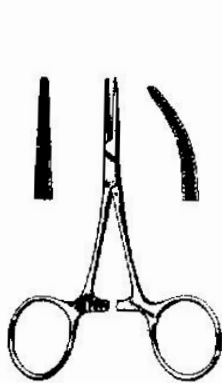

HARTMAN
STR CUR
17-120 10cm 17-122

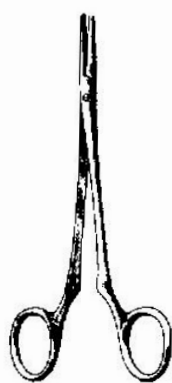

HALSTEAD MOSQUITO
17-130 12.5cm
17-132 12.5cm CUR

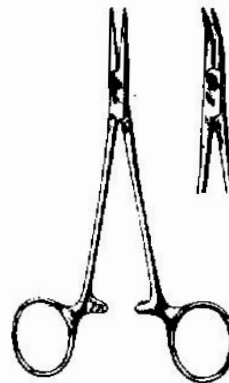

HALSTEAD MOSQUITO
STR CUR
17-140 12.5cm 17-142



1:2 HALSTEAD MOSQUITO
STR CUR
17-150 12.5cm 17-152

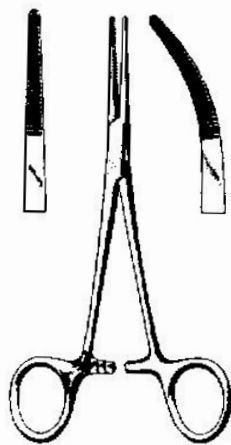

KELLY
STR CUR
17-160 14cm 17-162

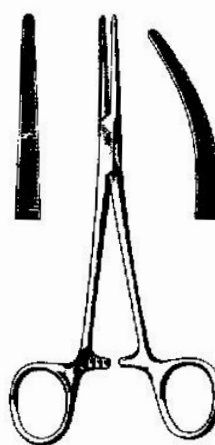

CRILE
STR CUR
17-170 14cm 17-172

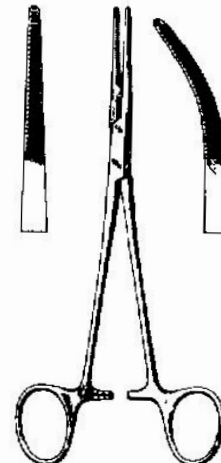

KELLY-RANKIN
STR CUR
17-180 16cm 17-182

GENERAL INSTRUMENTS

HAEMOSTATIC FORCEPS

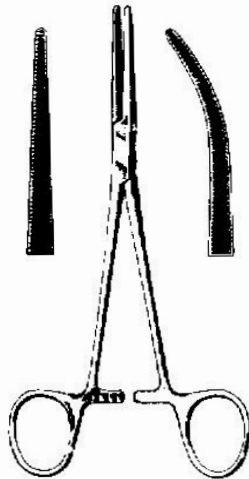

CRILE-RAKIN
STR CUR
17-190 16cm 17-192

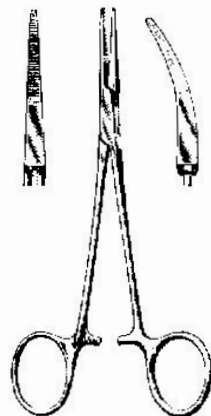

PROVIDENCE-HOSPITAL
STR CUR
17-200 14cm 17-202

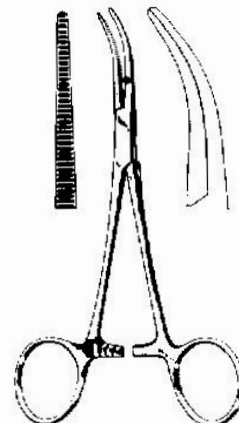

DANDY
17-210 14cm

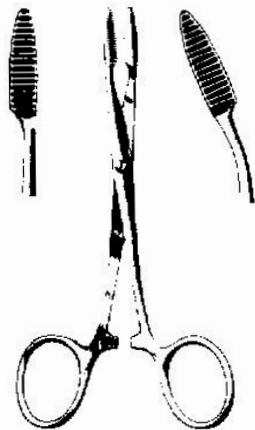

PEAN
STR CUR
17-220 12.5cm 17-230
17-222 14 cm 17-232
17-224 16 cm 17-234

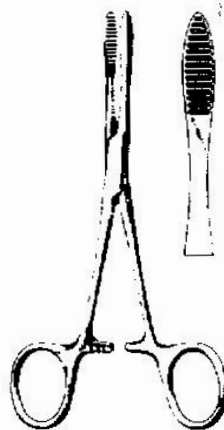

PEAN
17-240 14cm
17-242 16cm

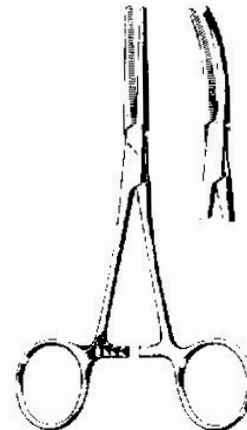

POCHESTER PEAN
STR CUR
17-250 12.5cm 17-260
17-251 14 cm 17-261
17-252 16 cm 17-262
17-253 18 cm 17-263
17-254 20 cm 17-264
17-255 24 cm 17-265
17-256 26 cm 17-266

GENERAL INSTRUMENTS

HAEMOSTATIC FORCEPS

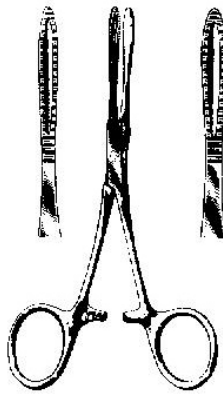

KROENLEIN
17-270 14cm 17-272

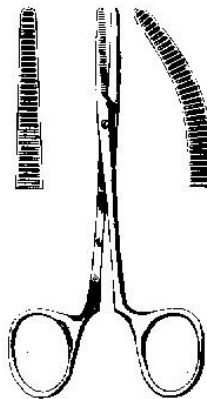

SPENCERWELLS
STR CUR
17-280 12.5cm 17-290
17-282 15 cm 17-292
17-284 18 cm 17-294
17-286 20 cm 17-296
17-288 23 cm 17-298

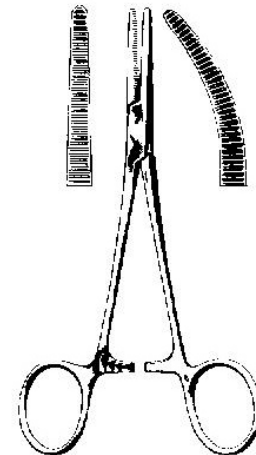

SPENCERWELLS
STR CUR
17-300 12.5cm 17-310
17-302 15 cm 17-312
17-304 18 cm 17-314
17-306 20 cm 17-316
17-308 23 cm 17-318

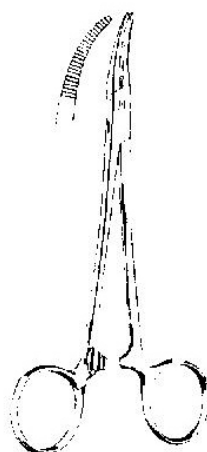

KILNER
17-320 14cm

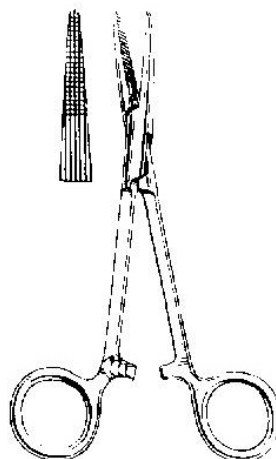

GREY-TURNER
17-330 15cm

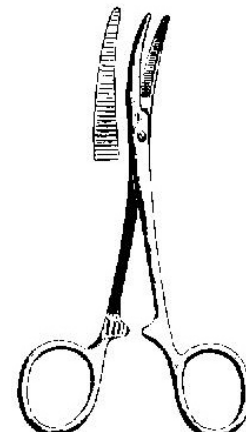

DUNHILL
17-340 12.5cm

GENERAL INSTRUMENTS
HAEMOSTATIC FORCEPS

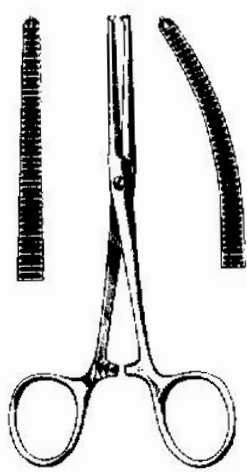

KOCHER
STR CUR
17-350 12.5cm 17-360
17-352 14 cm 17-362
17-354 15 cm 17-364
17-356 18 cm 17-366
17-358 20 cm 17-368

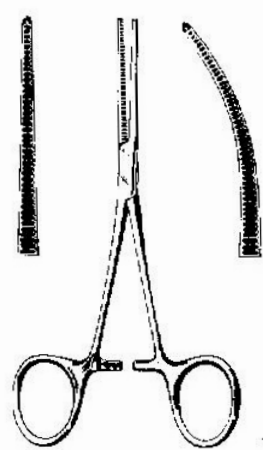

KOCHER
STR CUR
17-370 12.5cm 17-380
17-371 14 cm 17-381
17-372 15 cm 17-382
17-373 16 cm 17-383
17-374 18 cm 17-384
17-375 20 cm 17-385
17-376 23 cm 17-386
17-377 26 cm 17-387

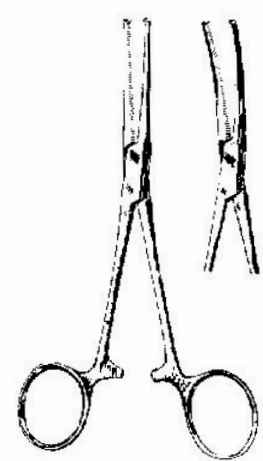

ROCHESTER OCHSNER
STR CUR
17-390 14cm 17-400
17-391 16cm 17-401
17-392 18cm 17-402
17-393 20cm 17-403
17-394 22cm 17-404
17-395 24cm 17-405
17-396 26cm 17-406

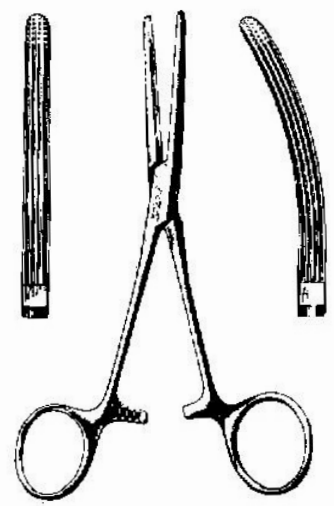

ROCHESTER CARMALT
STR CUR
17-410 16cm 17-420
17-412 20cm 17-422

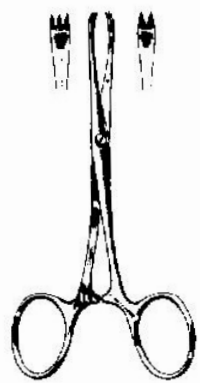

CHAPUT
17-430 13cm



LANE
17-440 12.5cm
17-442 15 cm
17-444 19 cm

GENERAL INSTRUMENTS

HAEMOSTATIC FORCEPS

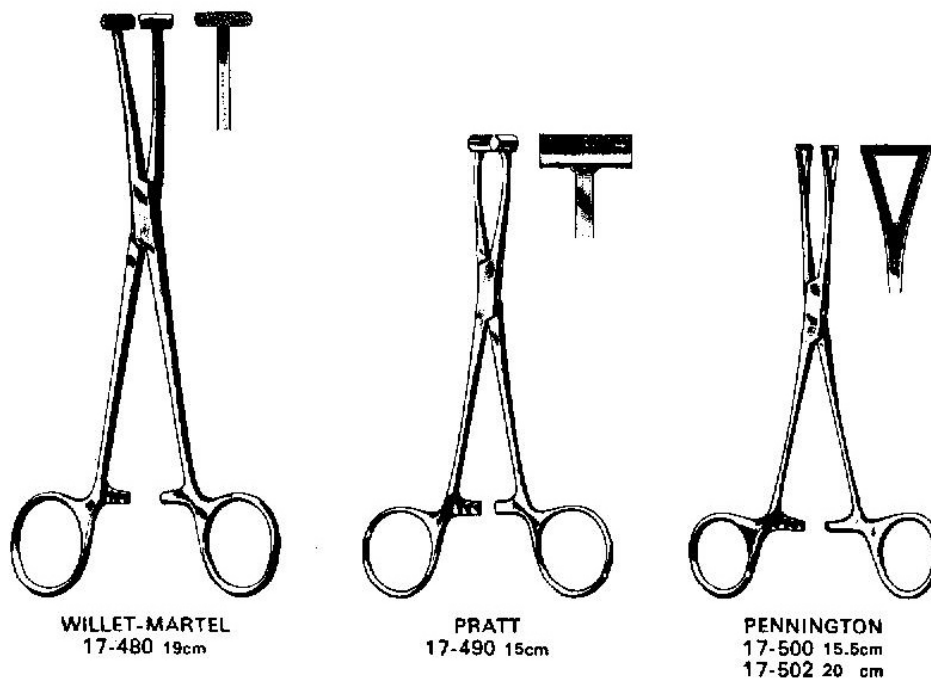
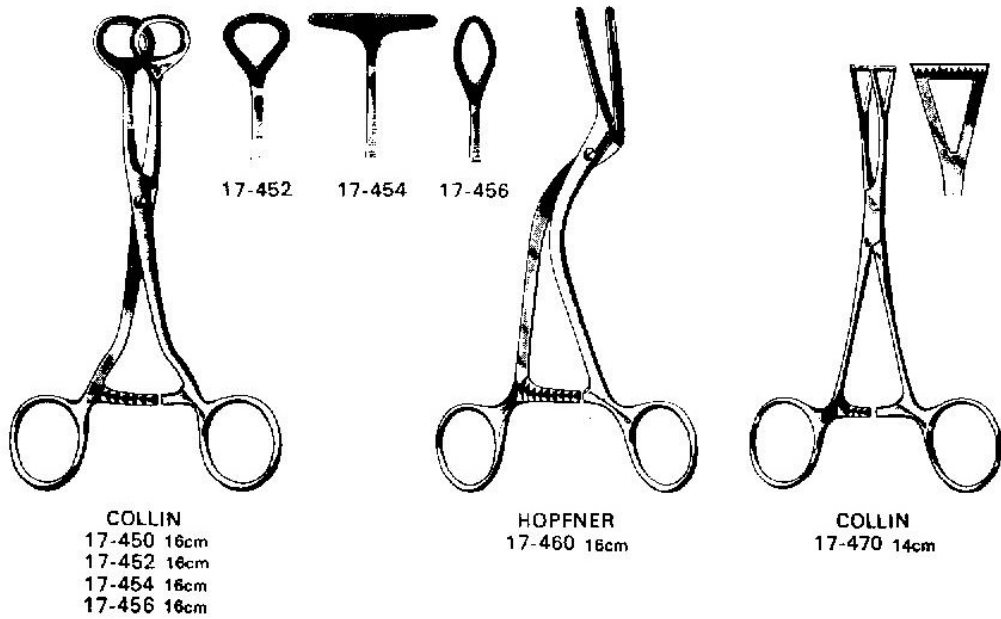

GENERAL INSTRUMENTS

HAEMOSTATIC FORCEPS

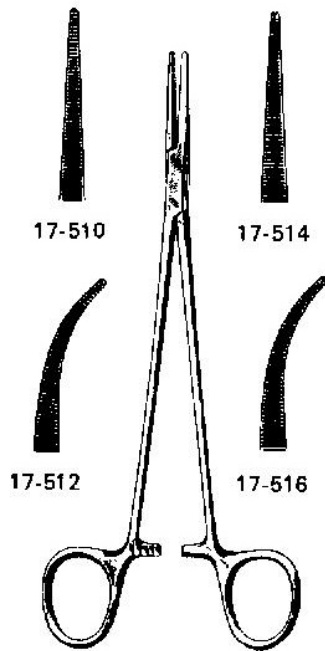

17-510

17-514

17-512

17-516

HALSTEAD MOSQUITO

	STR	CUR	
17-510	18cm	17-512	
17-514	1:2 18cm	1:2 17-516	
17-520	20cm	17-522	
17-524	1:2 20cm	1:2 17-526	

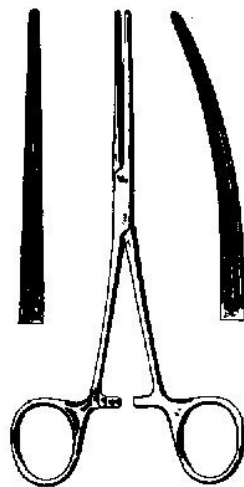

BAINBRIDGE

	STR	CUR
17-550	15cm	17-560
17-552	18cm	17-562

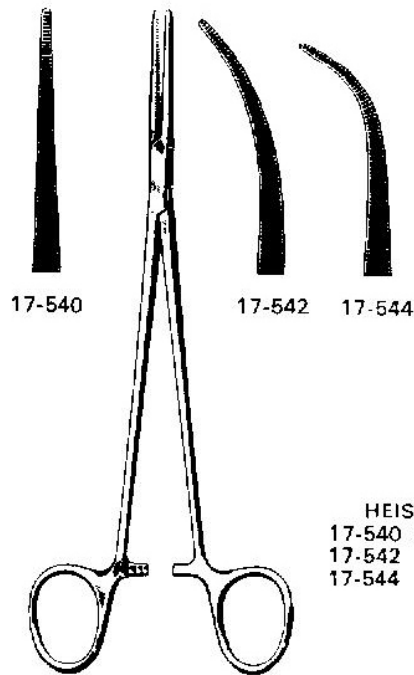

17-540

17-542

17-544

HEISS

17-540	20cm
17-542	"
17-544	"

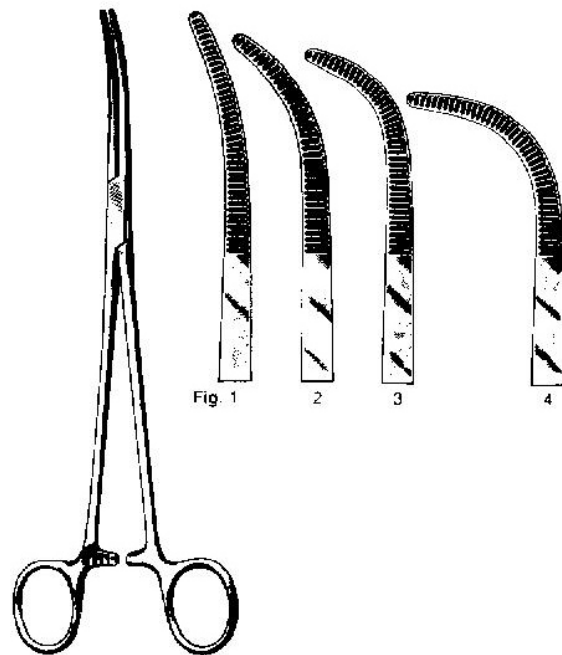

Fig. 1

2

3

4

RUMMEL

17-570	Fig. 1	23cm
17-572	Fig. 2	23cm
17-574	Fig. 3	23cm
17-576	Fig. 4	23cm

GENERAL INSTRUMENTS

HAEMOSTATIC AND GALL DUCT FORCEPS

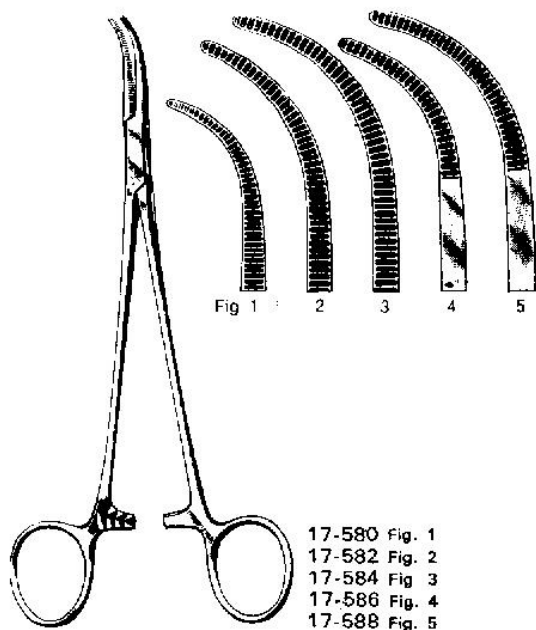

OVERHOLT - GEISSENDORFER
21cm

- 17-580 Fig. 1
- 17-582 Fig. 2
- 17-584 Fig. 3
- 17-586 Fig. 4
- 17-588 Fig. 5

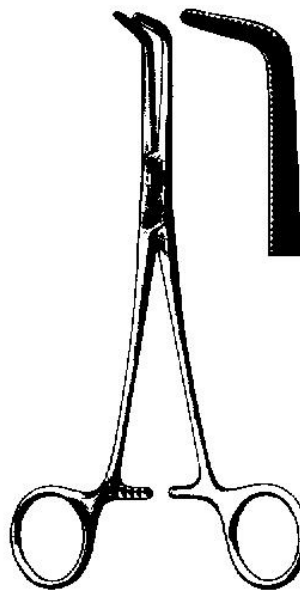

MIXTER
17-590 15.5cm
17-592 19 cm

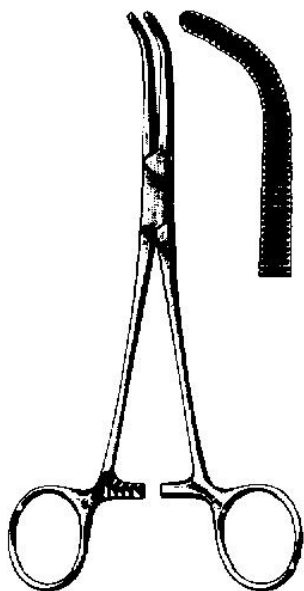

MIXTER
17-600 22cm

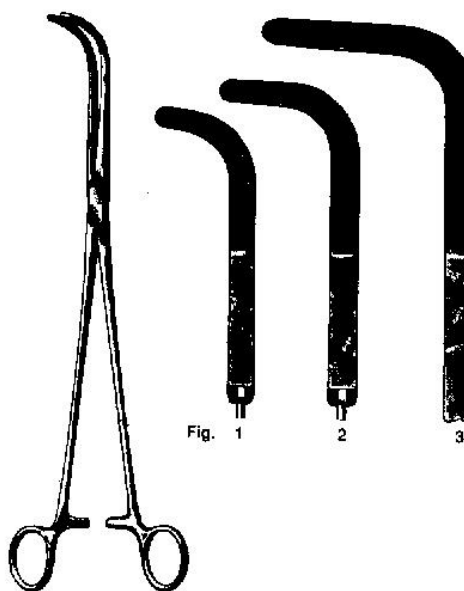

MIXTER
17-610 Fig. 1 22cm
17-612 Fig. 2 25cm
17-614 Fig. 3 28cm



GENERAL INSTRUMENTS

GALL DUCT FORCEPS

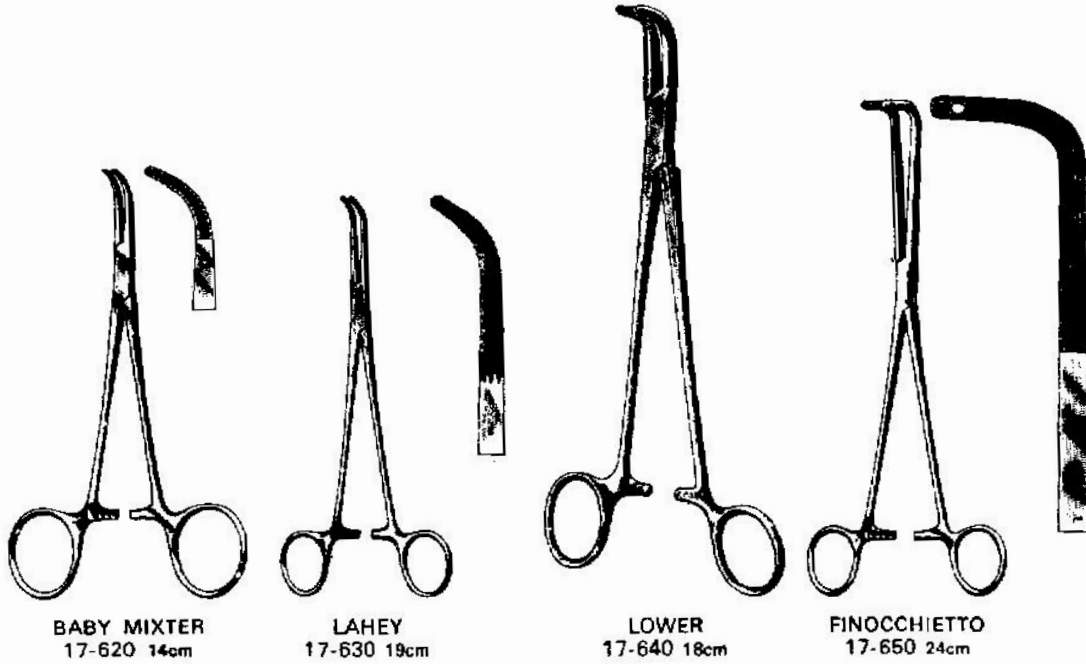

KIDNEY PEDICAL FORCEPS

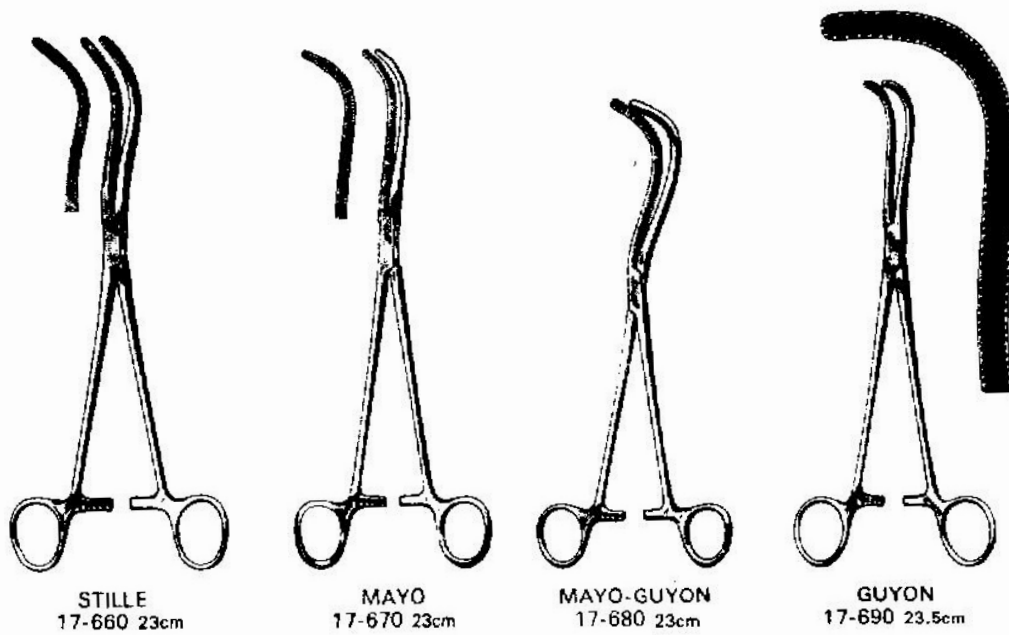

GENERAL INSTRUMENTS

GALL DUCT FORCEPS

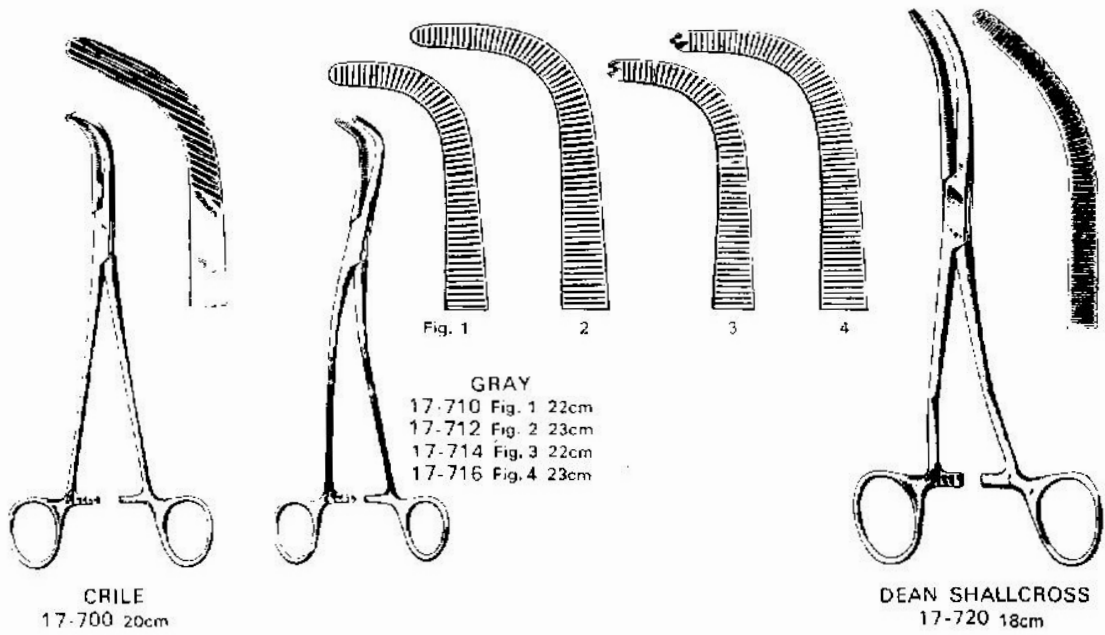

PERITONEAL FORCEPS

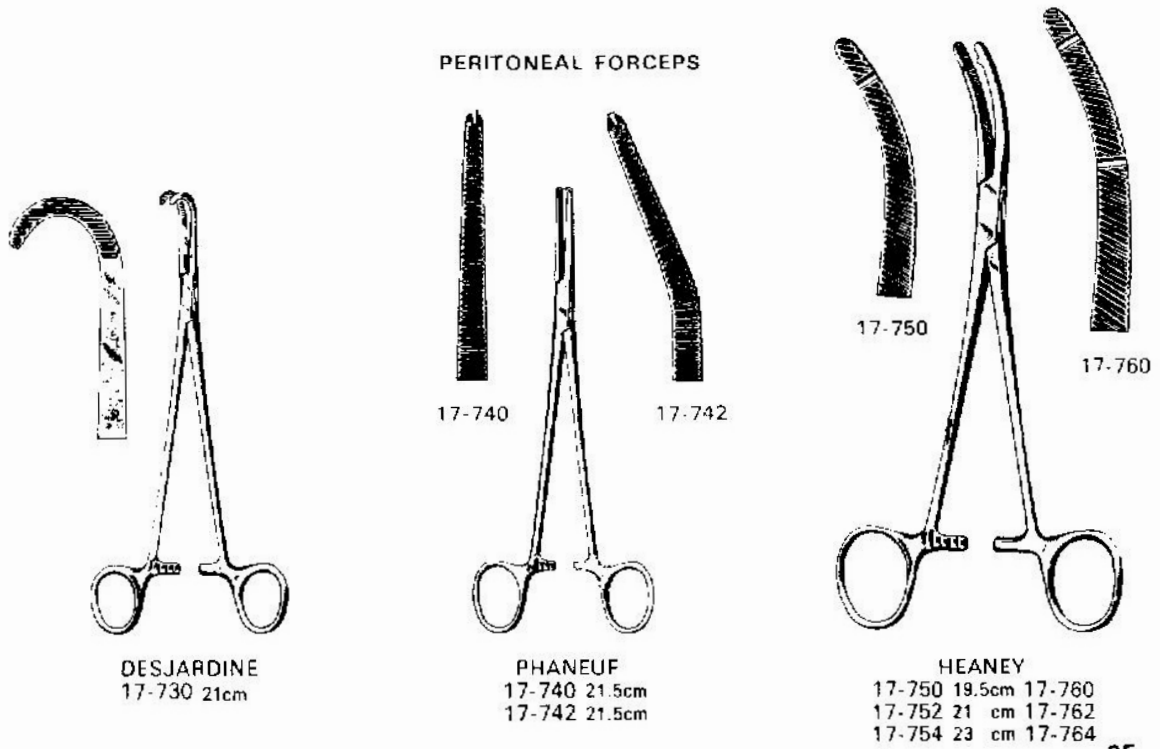

GENERAL INSTRUMENTS

HYSTERECTOMY FORCEPS

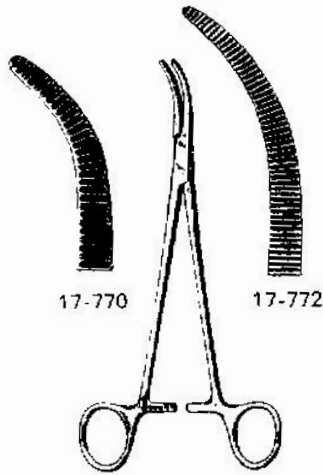

MOYNIHAN
17-770 23cm
17-772 24cm

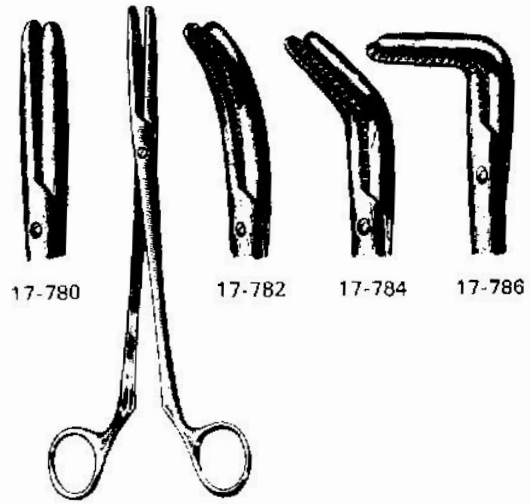

SPENCERWELLS
17-780 24cm
17-782 24cm
17-784 24cm
17-786 24cm

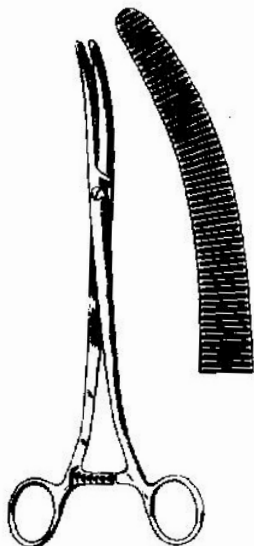

FAURE
17-790 25cm

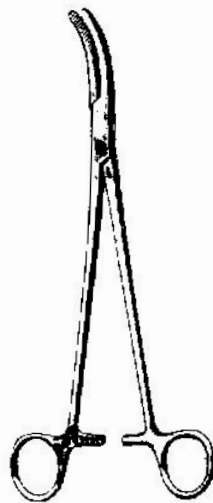

WERTHEIM
17-800 25cm

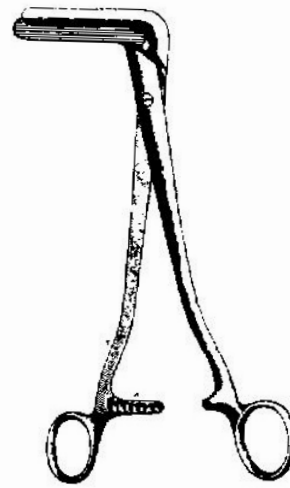

WERTHEIM
17-810 23cm

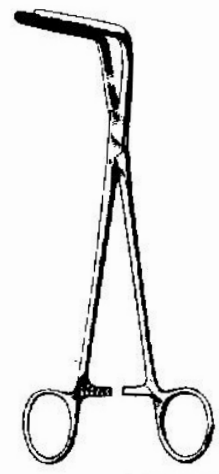

WERTHEIM-CULLEN
17-820 21.5cm

GENERAL INSTRUMENTS

PERITONEAL FORCEPS

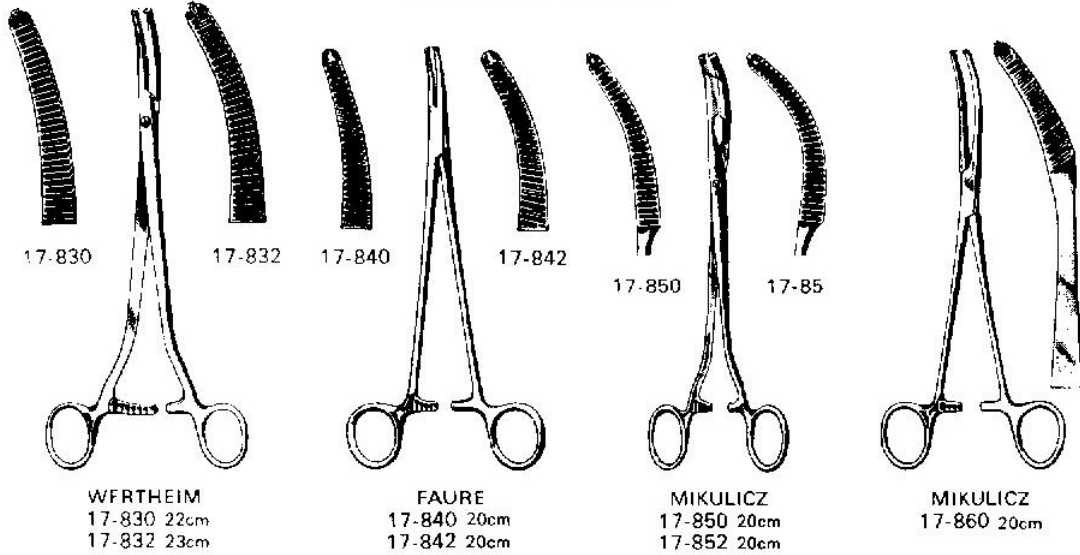

BRONCHUS FORCEPS

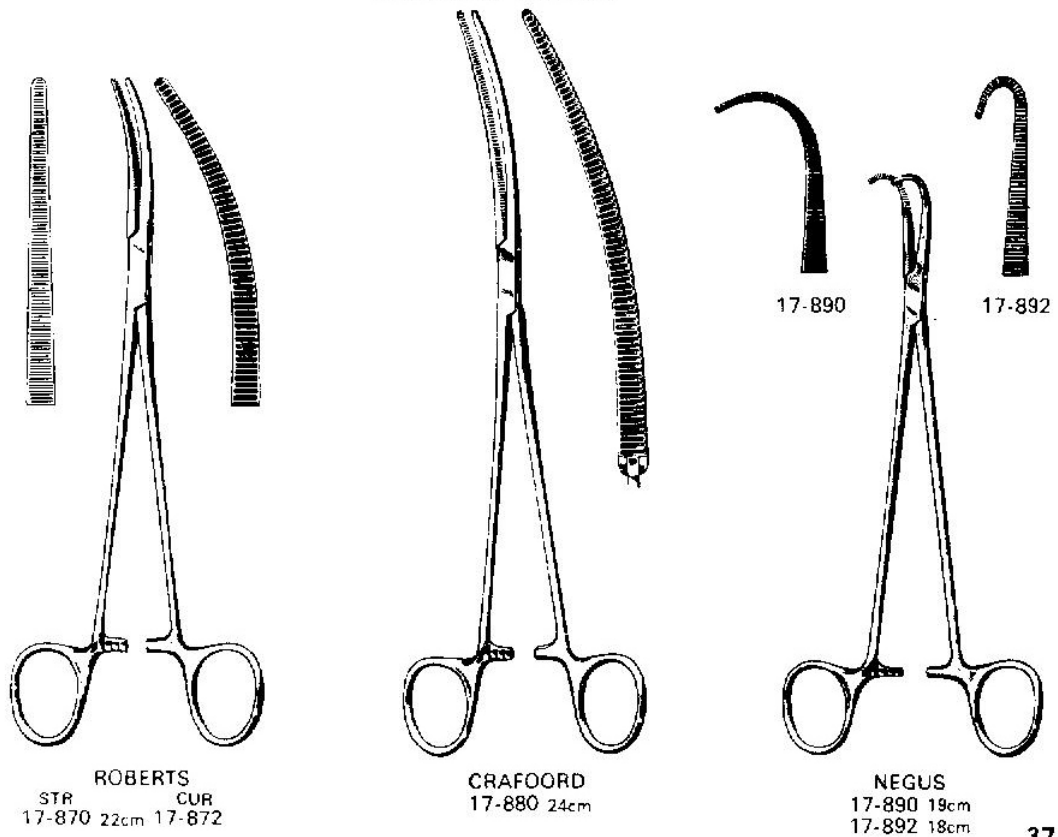



GENERAL INSTRUMENTS
TOWEL CLAMPS



BACKHAUS
17-900 8cm
17-902 10cm
17-904 13cm

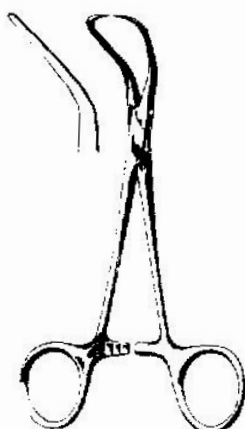

BACKHAUS
17-910 8cm
17-912 10cm
17-914 13cm



BACKHAUS-ROEDER
17-920 13cm
17-922 15cm

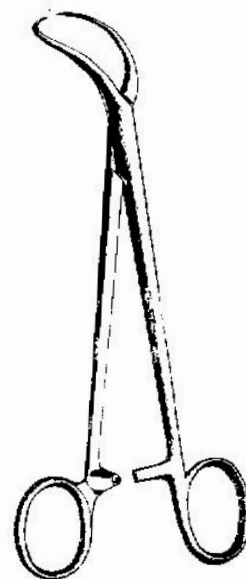

MAYO
17-930 14cm

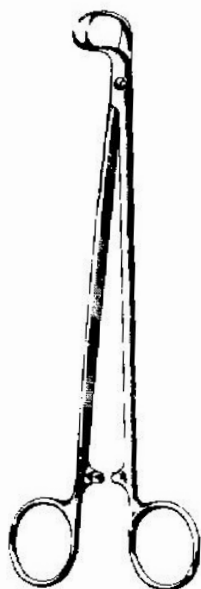

MOYNIHAN
17-940 19cm



MOYNIHAN
17-950 18cm



DOYEN
17-960 18cm



SCHAEDEL
17-970 9cm



JONES
17-980 9cm



SURGICAL INSTRUMENTS

GENERAL INSTRUMENTS
SINUS AND DRESSING FORCEPS

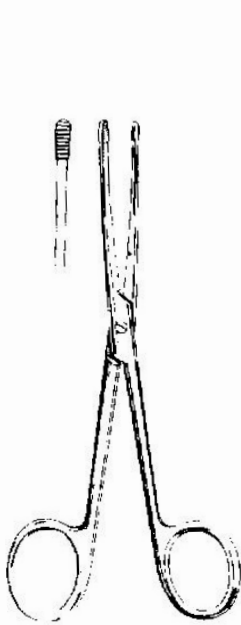

LISTER
19-790 12.5cm
19-792 15 cm
19-794 18 cm
19-796 20 cm

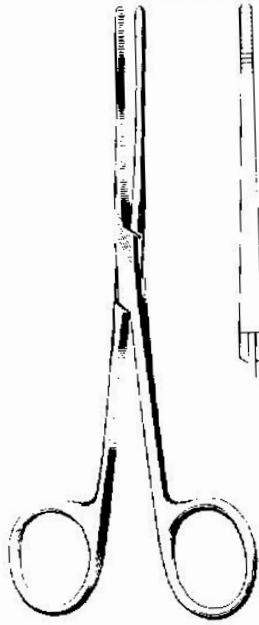

LISTER
19-800 12.5cm
19-802 15 cm
19-804 18 cm
19-806 20 cm



BRYANT
19-810 12.5cm

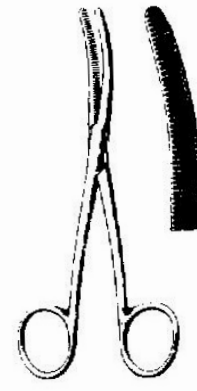

BRYANT
19-820 12.5cm



FRENCH
STR 19-830 12.5cm CUR 19-832



GROSS
STR 19-840 14cm CUR 19-850
19-842 16cm 19-952

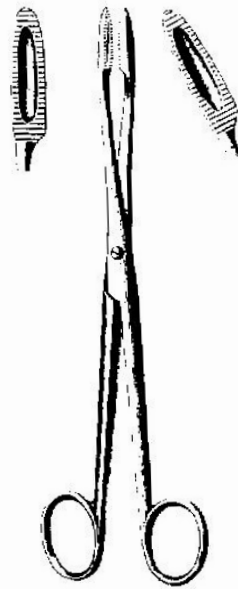

GROSS
STR 19-860 18cm CUR 19-870
19-862 20cm 19-872

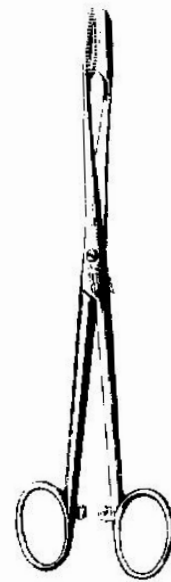

GROSS
STR 19-880 18cm CUR 19-890
19-882 20cm 19-892

GENERAL INSTRUMENTS
DRESSING FORCEPS

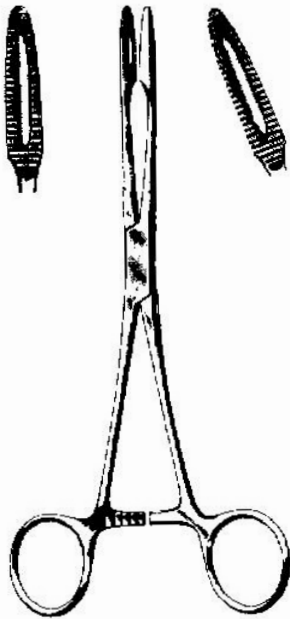

GROSS
STR 19-900 20cm CUR 17-902



MAIER
STR 19-910 25cm CUR 17-912

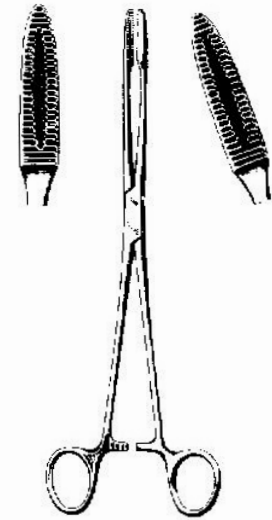

MAIER
STR 19-920 25cm CUR 19-922

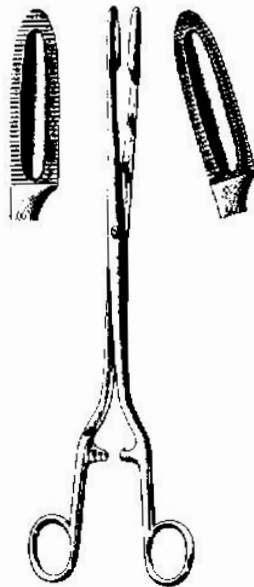

SIMS-MAIER
STR 19-930 28cm CUR 19-932



COLLIN
19-940 25cm

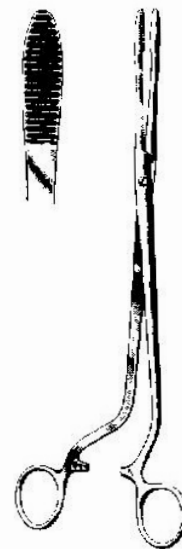

CHERON
19-950 25cm

GENERAL INSTRUMENTS

DRESSING AND SPONGE FORCEPS



19-960 26cm

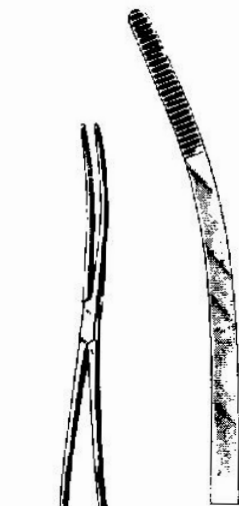

BOZEMAN
9-962 28cm

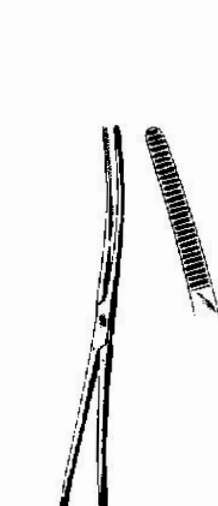

BOZEMAN-DOUGLAS
19-970 26cm



EMMET
19-980 23cm

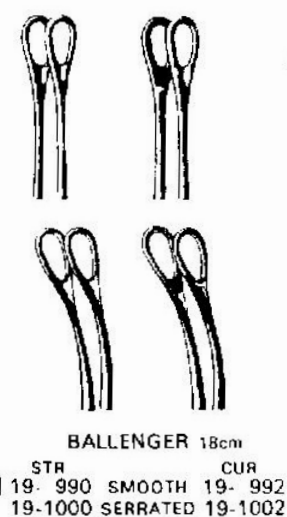

BALLENGER 18cm
STR CUR
19-990 SMOOTH 19-992
19-1000 SERRATED 19-1002



RAMPLEY
19-1030 18cm
19-1032 25cm

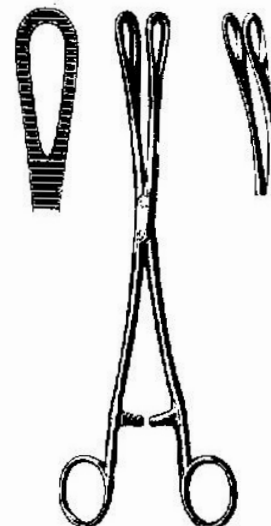

RAMPLEY
19-1040 18cm
19-1042 25cm

FOERSTER 25cm
19-1010 SMOOTH 19-1012
19-1020 SERRATED 19-1022



GENERAL INSTRUMENTS
RETRACTORS



FARABEU
21-100 12cm
21-102 15cm



PARKER
21-110 13.5cm



U. S. ARMY
21-120 21cm



ROUX
21-130 Set
21-132 14cm
21-134 15cm
21-136 16cm

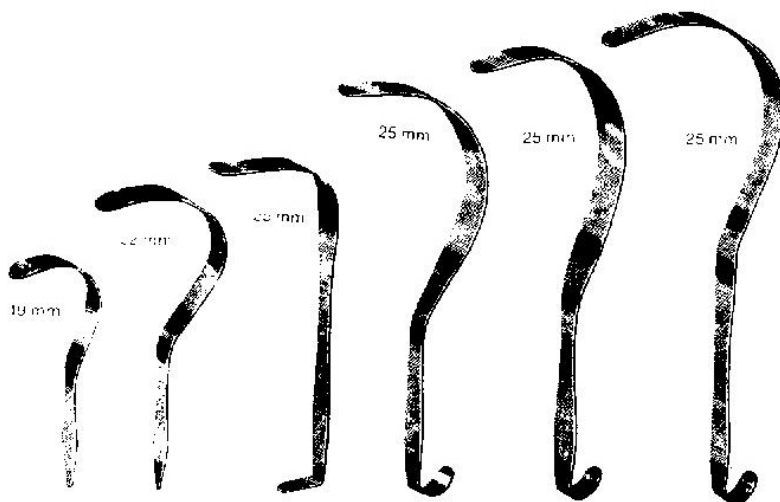

DEAVER
21-140 18cm 21-141 21.5cm 21-142 25cm 21-143 30cm 21-144 33cm 21-145 36cm



GENERAL INSTRUMENTS

RETRACTORS

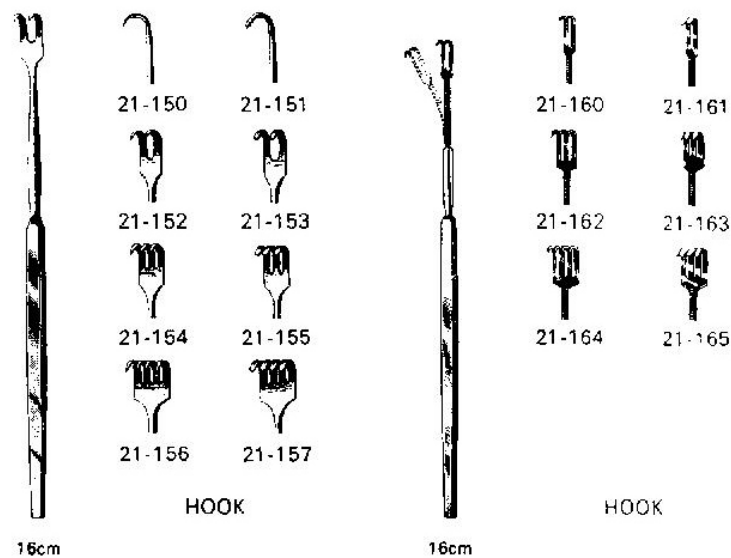
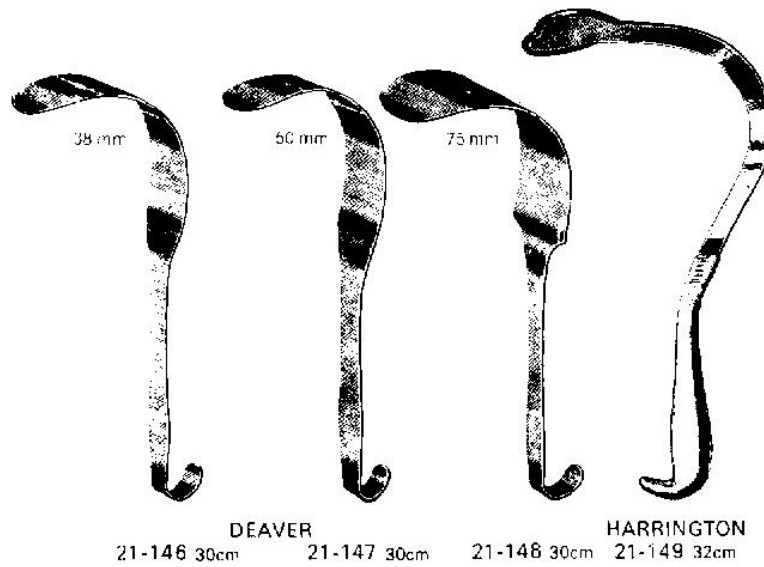

GENERAL INSTRUMENTS

RETRACTORS



KOCHER
22cm



21-170



21-171



21-172



21-173



21-174



21-175



21-176



21-177



21-178



21-179



VOLKMAN
21.5cm



21-180



21-181



21-182



21-183



21-184



21-185



21-186



21-187



21-188



21-189



GENERAL INSTRUMENTS

RETRACTORS

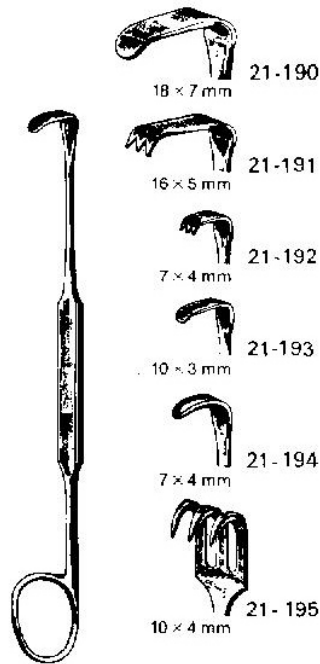

MEYERING
18cm

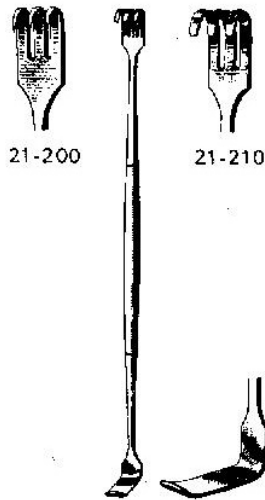

SENN-MULLER
16cm

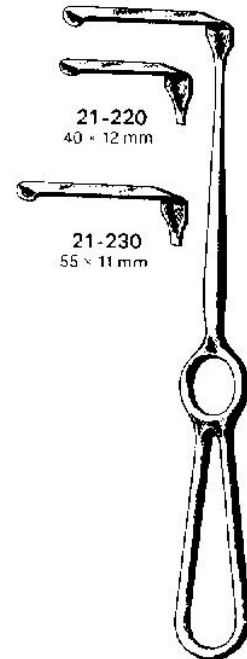

KOCHER
21cm

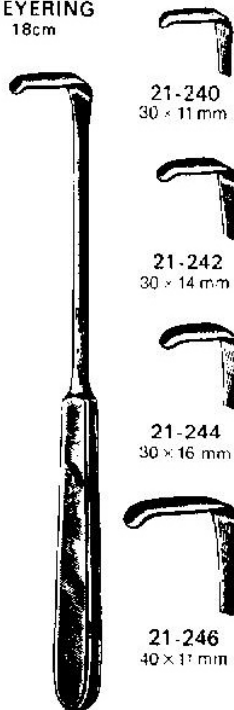

LANGENBECK
21cm



LANGENBECK
21-250
21-252

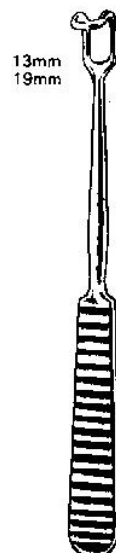

DURHAM
21-260
21-262

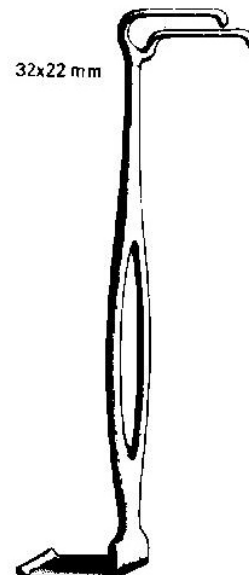

CZERNY
21-270 20cm

GENERAL INSTRUMENTS
RETRACTORS

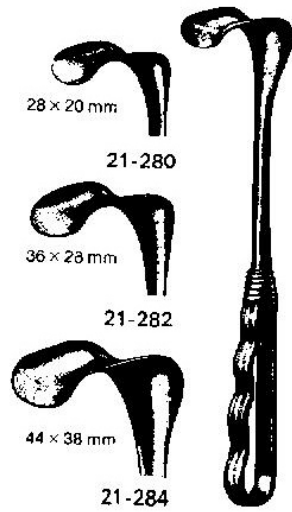

21-280

21-282

21-284

RICHARDSON
24cm



49 x 38 mm
28 x 20 mm

36 x 28 mm
63 x 49 mm

RICHARDSON-EAST
21-290 26cm
21-292 28cm



40 x 10 mm
40 x 15 mm
40 x 20 mm

KOCHER
21-300 22cm

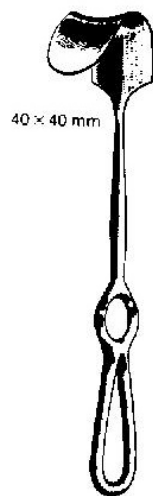

40 x 40 mm

FRITSCH
21-310 24cm

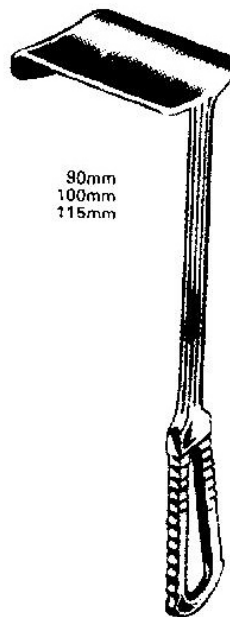

90mm
100mm
115mm

MORRIS
21-320 90mm
21-322 100mm
21-324 115mm



57x64mm 48mm

57x50mm 48mm

MORRIS
21-330



SURGICAL INSTRUMENTS

GENERAL INSTRUMENTS

RETRACTORS

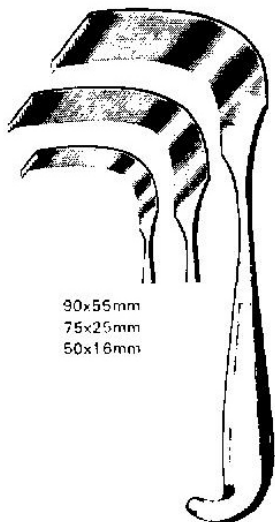

90x55mm
75x25mm
50x16mm

MEYERDUNG
21-340 24cm
21-342 22cm
21-344 20cm

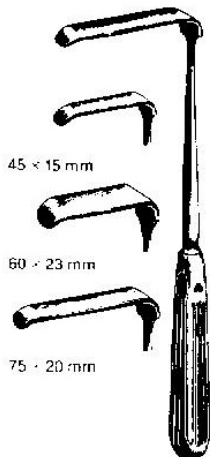

45 x 15 mm
60 x 23 mm
75 x 20 mm

SAUERBRUCH
21-350 22.5cm

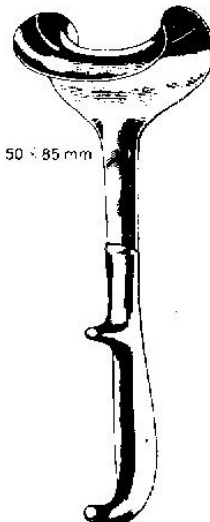

50 x 85 mm

DOYEN
21-360 25cm

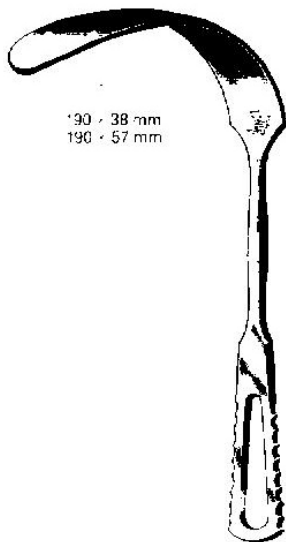

190 x 38 mm
190 x 57 mm

KELLY
21-370 27cm

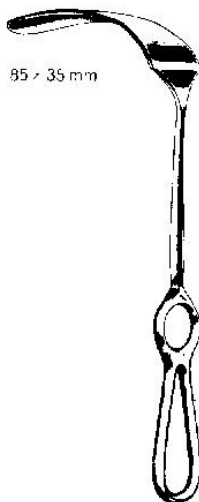

85 x 35 mm

MIKULICZ
21-380 26cm

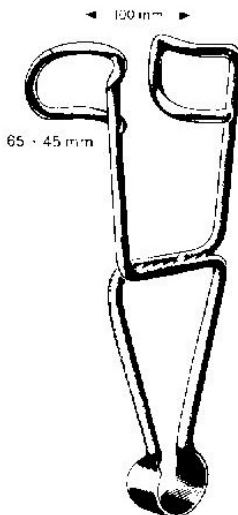

120 mm
65 x 45 mm

DARTIGUS
21-390

GENERAL INSTRUMENTS
RETRACTORS

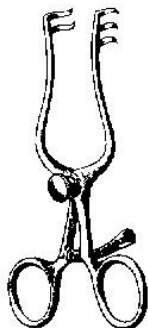

WEITLANER
21-400 10.5cm SHARP
21-402 10.5cm BLUNT

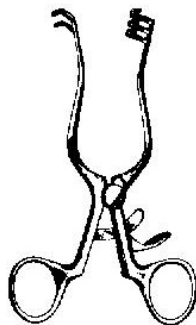

WEITLANER
21-410 10.5cm SHARP
21-412 10.5cm BLUNT

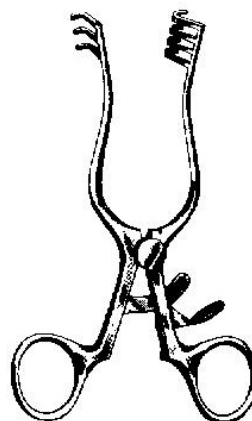

WEITLANER
21-420 13 cm SHARP
21-422 16.5cm SHARP
21-424 13 cm BLUNT
21-426 16.5cm BLUNT

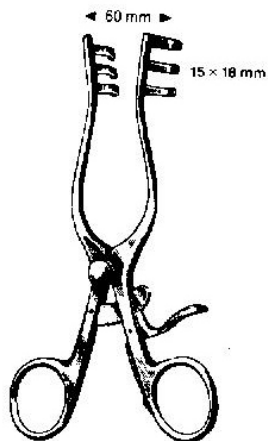

WEST
21-430 13cm



JANSEN
21-440 10cm

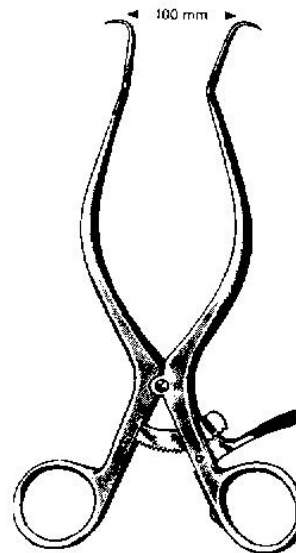

GELPI
21-450 18cm

GENERAL INSTRUMENTS
RETRACTORS

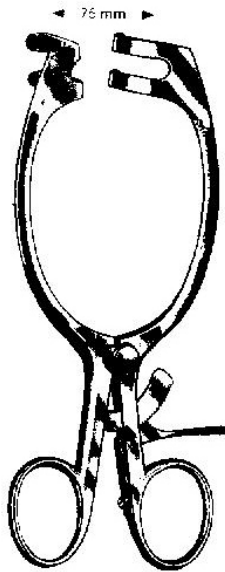

MAYO-ADAMS
21-460
21-462 W/CENTRE BLADE

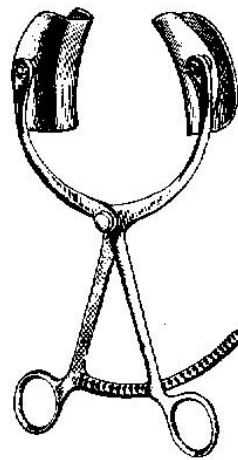

COLLIN
21-470
21-472 W/CENTRE BLADE

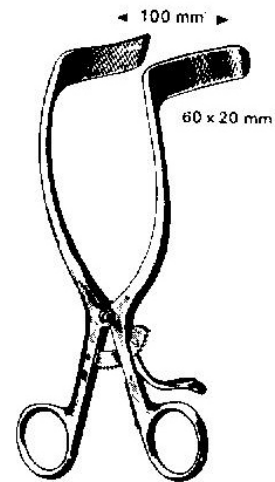

RIGBY
21-480 18cm

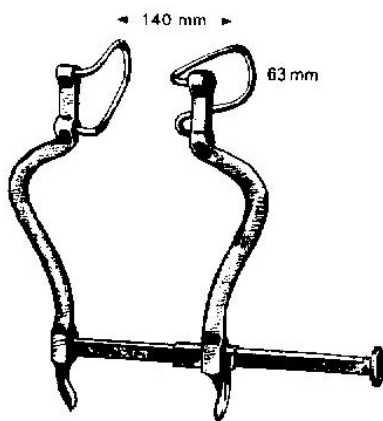

GOSSET
21-490

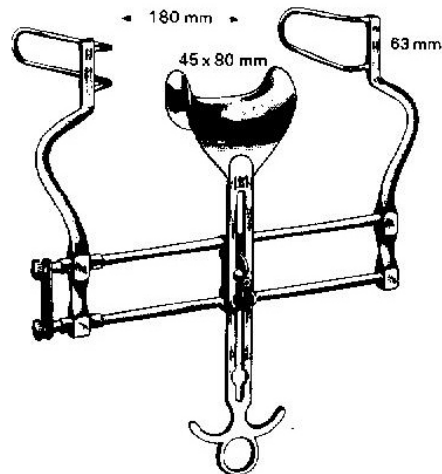

BALFOUR
21-500



SURGICAL INSTRUMENTS

GENERAL INSTRUMENTS

PROBES

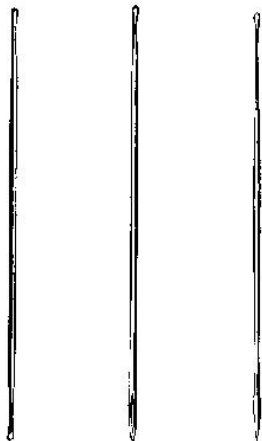

- | | | |
|---------------|--------|---------------|
| 23-100 11.5cm | 23-110 | 23-120 12.5cm |
| 23-101 12.5cm | 23-111 | 23-122 14 cm |
| 23-102 14 cm | 23-112 | 23-124 16 cm |
| 23-103 16 cm | 23-113 | |
| 23-104 18 cm | 23-114 | |
| 23-105 20 cm | 23-115 | |
| 23-106 25 cm | 23-116 | |

DIRECTOR

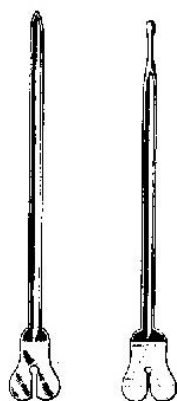

- | | |
|---------------|--------|
| 23-130 12.5cm | 23-140 |
| 23-132 14 cm | 23-142 |
| 23-134 16 cm | 23-144 |

SAFETY PIN

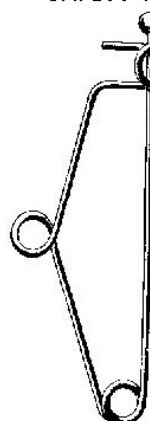

- MAYO**
23-150 14cm

SPATULA



- PLASTER**
23-160 13cm
23-162 16cm

NEEDLES

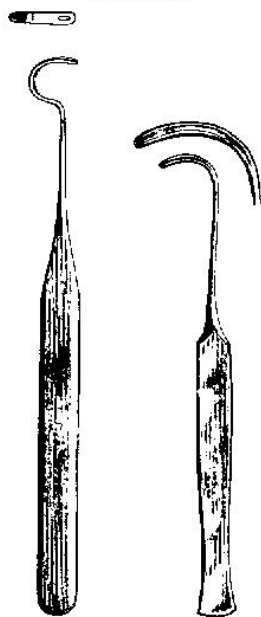

- 23-170 13cm **SYME**
23-180

DISSECTORS

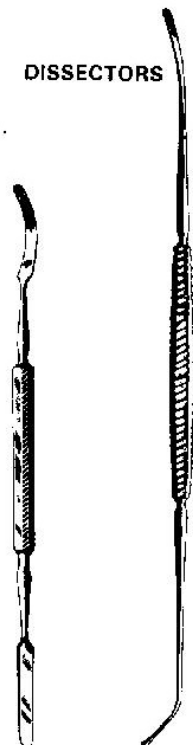

- McDONALD** **CHEYNE**
23-190 19cm 23-200 12.5cm
23-202 17.5cm

APPLICATORS

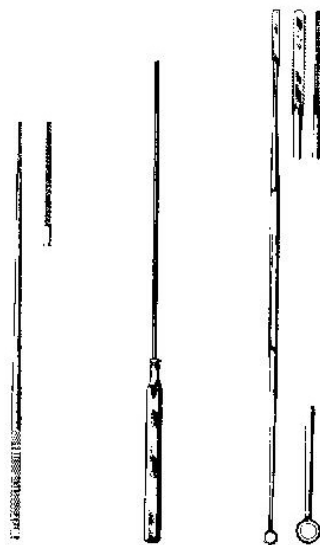

- | | |
|----------------|---------------------|
| FARRELL | JOBSON-HORNE |
| 23-210 12cm | 23-220 |
| 23-212 14cm | 23-222 |
| 23-214 16cm | 23-224 |
| 23-216 18cm | 23-226 |
| | 23-230 12.5cm |
| | 23-232 18 cm |



**SUTURE
NEEDLE HOLDERS**

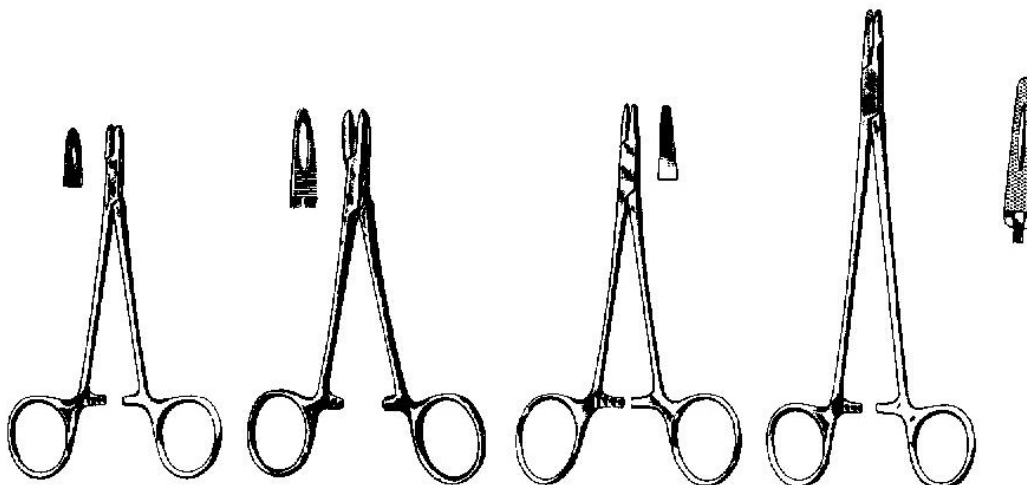

DERF
25-100 12cm

COLLIER
25-110 12.5cm

WEBSTER
25-120 13cm

MAYO HEGAR
25-130 14cm
25-131 16cm
25-132 18cm
25-133 20cm
25-134 24cm
25-135 26cm



CRILEWOOD
25-140 15cm

CRILEMURRAY
25-150 15cm

WRIGHT
25-160 13cm

BRUCE - CLARKE
25-170 12.5cm

**SUTURE
NEEDLE HOLDERS**

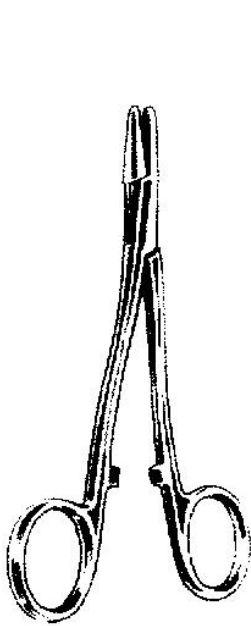

KILNER
25-180 13.5cm

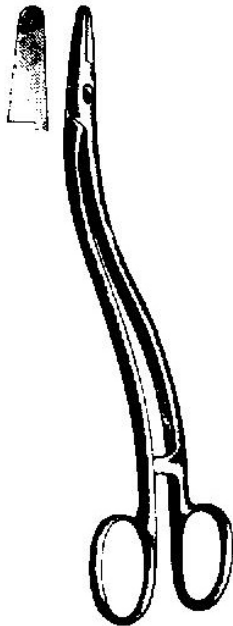

THOMSON-WALKER
25-190 18cm

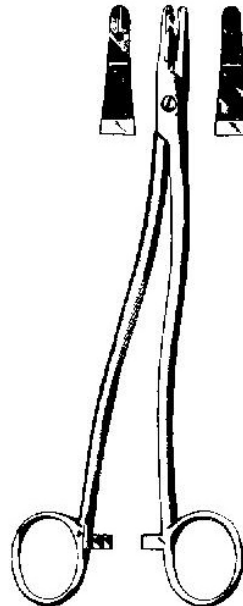

BOZEMAN
25-200 20cm

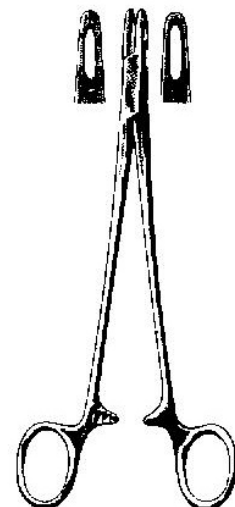

METZENBAUM
25-210 18cm

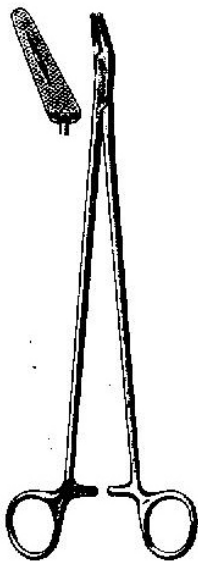

FINOCHIETTO
25-220 17cm

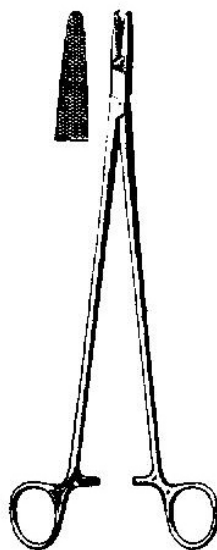

WANGENSTEEN
25-230 27cm

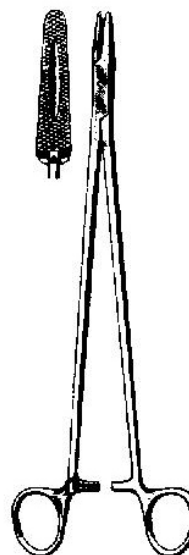

MASSON
25-240 27cm

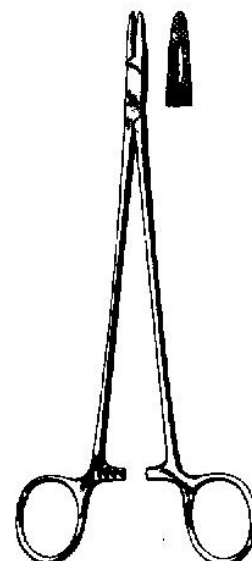

SAROT
25-250 18cm
25-252 26cm

**SUTURE
NEEDLE HOLDERS**

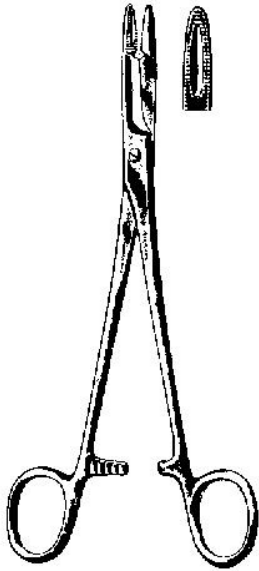

OLSEN
25-260 14 cm
25-262 16.5cm
25-264 19 cm

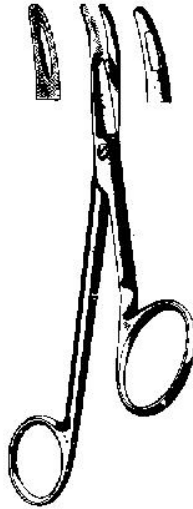

GILLIS
25-270 16cm

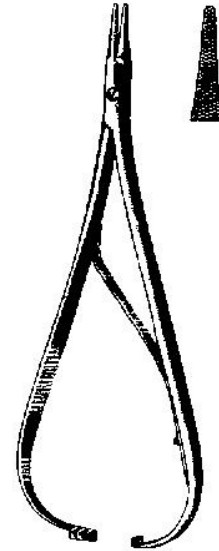

MATHIEU
25-280 11cm
25-282 14cm
25-284 17cm

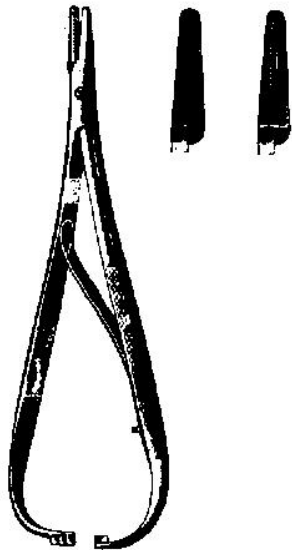

MATHIEU
25-290 14cm
25-292 17cm
25-294 20cm
25-296 24cm



25-300 14cm
25-302 17cm
25-304 20cm
25-306 24cm

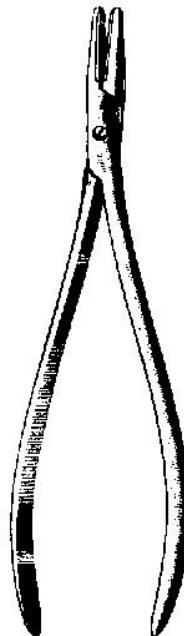

LANGENBECK
25-310 16cm
25-312 20cm

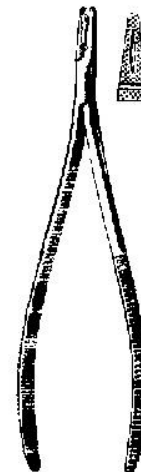

CRILE
25-320 15cm

**SUTURE
NEEDLE HOLDERS**

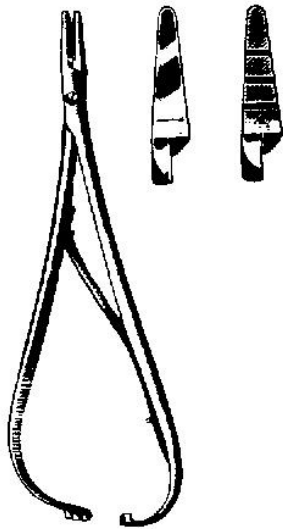

MACPHAIL
25-330 14cm
25-332 16cm
25-334 18cm
35-336 20cm

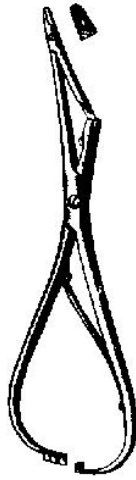

HALSTEAD
25-340 18.5cm
25-342 21 cm
25-344 24 cm

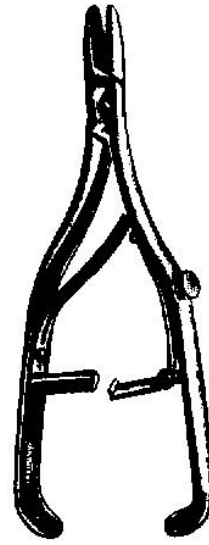

ROCHESTER-MAYO
25-350 18cm
25-352 20cm
25-354 22cm



STEVENS
25-360 13cm



KALT-ARRUGA
25-370 14cm



KALT
25-380 14cm



CASTROVIEJO
25-390 14cm

NEEDLES

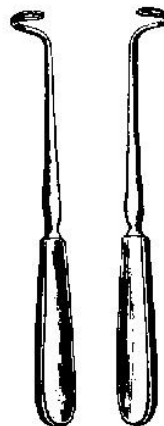

DESCHAMPS
25-400 21cm L
25-402 21cm R



DESCHAMPS
25-410 21cm L
25-412 21cm R



**SUTURE
NEEDLES**



REVERDIN
15cm



Fig. 1
25-420



2
25-422



3
25-424



4
25-426



25-442



25-444

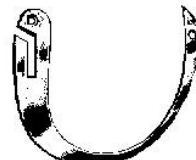

25-446



REVERDIN
19cm



Fig. 1
25-430



2
25-432



3
25-434



4
25-436



YOUNG BOOMRANG
25-440 25cm

**SUTURE
SUTURE FORCEPS**



MICHEL
25-450 12cm



MICHEL
25-460 12cm



WACHENFELDT
25-470 12.5cm



WACHENFELDT
25-480 12.5cm



HEGENBARTH
25-490 12.5



CHILD
25-500 18cm



CHILD
25-510 18cm

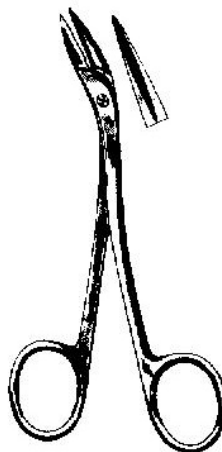

RICHTER-HEATH
25-520 14cm



MICHEL
25-530 13cm



MICHEL
25-540 12cm



SURGICAL INSTRUMENTS

PLASTER

SCISSORS

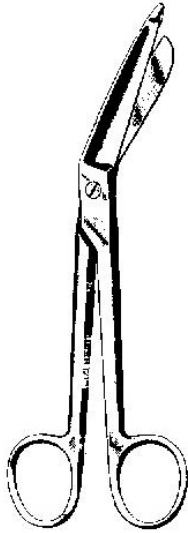

LISTER
27-100 9cm
27-102 11cm
27-104 14cm
27-106 18cm
27-108 20cm

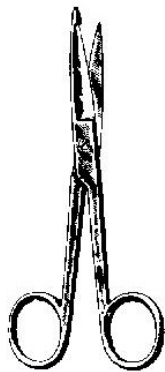

KNOWLES
27-120 14cm



ESMARCH
27-130 20cm

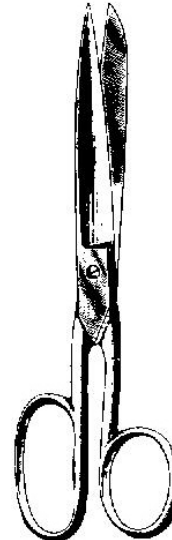

SMITH
27-140 16cm
27-142 18cm
27-144 20cm
27-146 23cm

SHEARS



SEUTIN
27-150 23cm



WIRE & CLOTHING
27-160 20cm

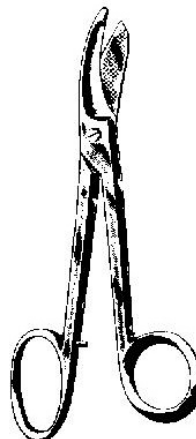

BRUNS
27-170 24cm

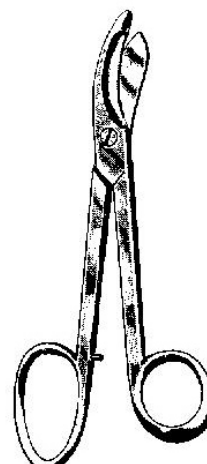

BRUNS
27-180 24cm

SURGICAL INSTRUMENTS

PLASTER

SHEAR

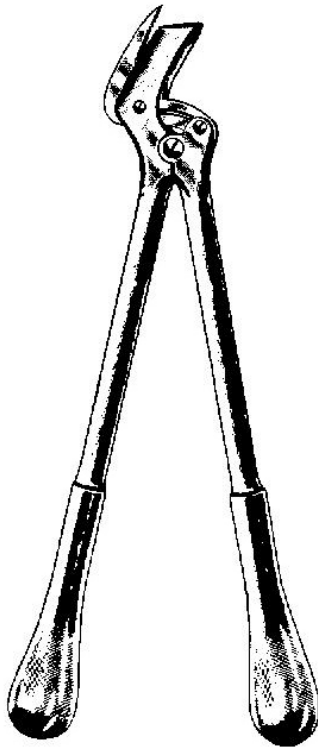

STILLE
27-190 23cm
27-192 26cm
27-194 37cm

SAW

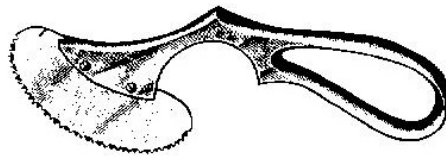

ENGEL
27-200

KNIFE



REINER
27-210 18cm

SPREADER

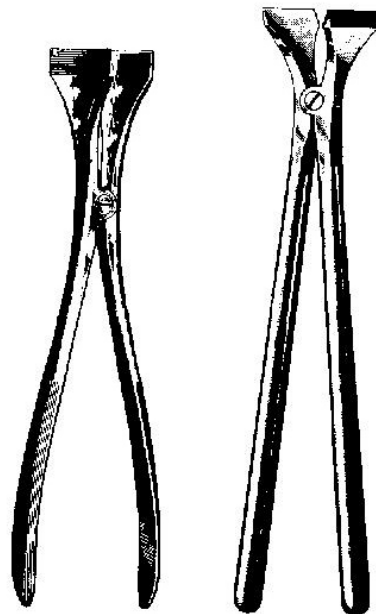

HENNING
27-240 28cm

BEESON
27-250 30cm

CAST BREAKER



WOLFF
27-230 19cm
27-232 23cm
27-234 26cm

RING CUTTER

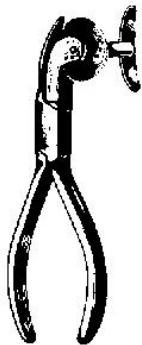

FINGER
27-220 16cm



SURGICAL INSTRUMENTS

BONE SURGERY

BONE SAWS



CHARRIERE
29-100 27 cm
29-102 30 cm
29-104 33 cm



SATTERLEE
29-110 31 cm

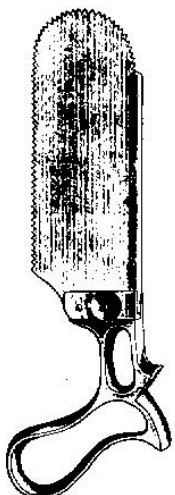

POST MORTEN
29-120 20 cm Blade

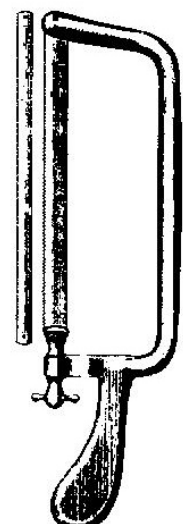

CHARRIERE
29-130 35 cm

BONE CHISELS AND GOUGES



OSTEOTOMES
13.5 cm
29-140 8 mm
29-142 10 mm
29-144 12 cm
29-146 14 cm
29-148 16 cm



CHISELS
13.5 cm
29-150 8 mm
29-152 10 mm
29-154 12 cm
29-156 14 cm
29-158 16 cm



GOUGES
13.5 cm
29-160
29-162
29-164
29-166
29-168



STILLE
20 cm
29-170 10 mm
29-172 15 mm
29-174 20 mm
29-176 25 mm



STILLE
20 cm
29-180 10 mm
29-182 15 mm
29-184 20 mm
29-186 25 mm



STILLE
20 cm
29-190
29-192
29-194
29-196

BONE SURGERY

BONE MALLETS

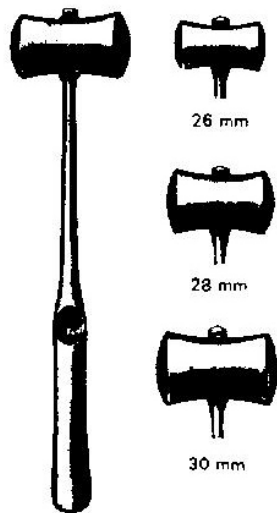

WILLIGER
29-200 24 cm

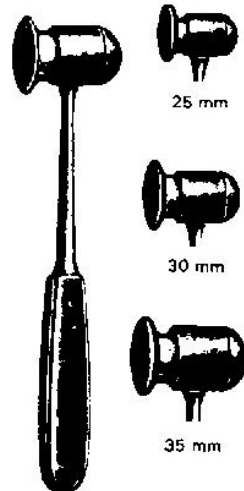

DOYEN
29-210 21 cm



COLLIN
29-220 20 cm

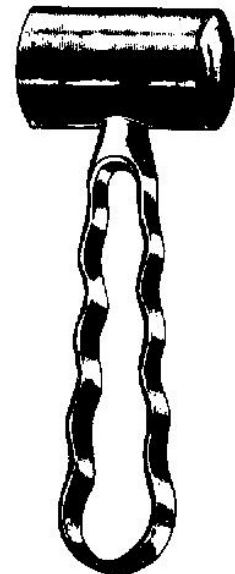

HEATH
29-230 18 cm

BONE SPOONS

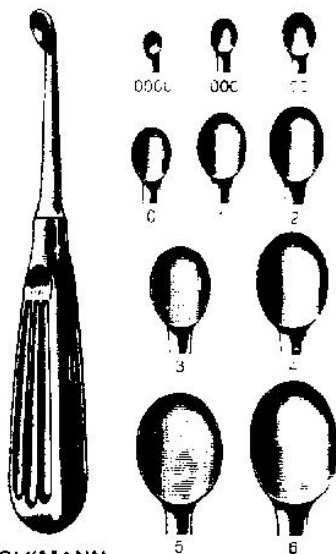

VOLKMANN
29-240
0000 To 6

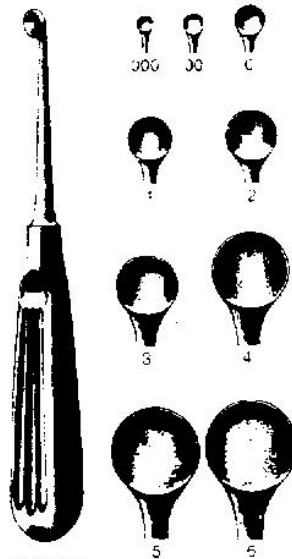

BRUNS
29-250
0000 To 6

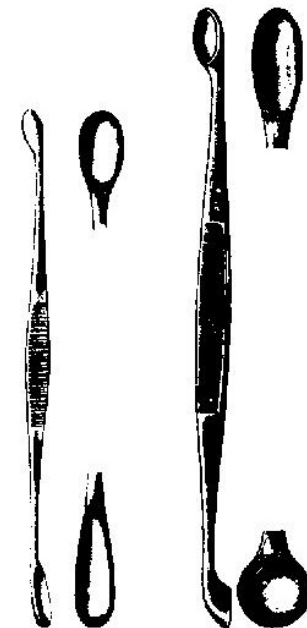

VOLKMANN **VOLKMANN**
29-260 13 cm 29-270
29-262 16.5 cm 29-272
29-264 20 cm 29-274



BONE SURGERY

RASPATORIES

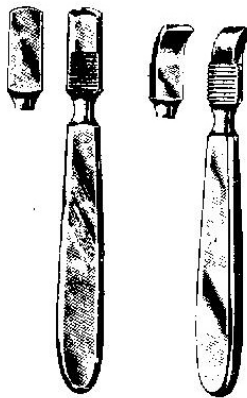

FARABEU
29-280 15 cm 29-290

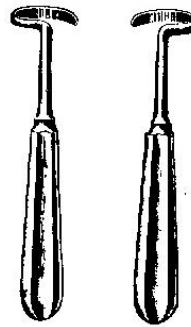

DOYEN
17 cm
29-300L ADULT 29-302 R
29-310L CHILD 29-312 R

ELEVATORS

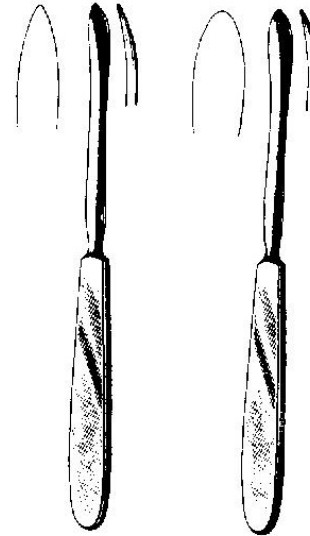

LANGENBECK
29-320 20 cm 29-330

ELEVATORS



WILLIGER
29-340 17 cm 29-350 16 cm

RASPATORIES

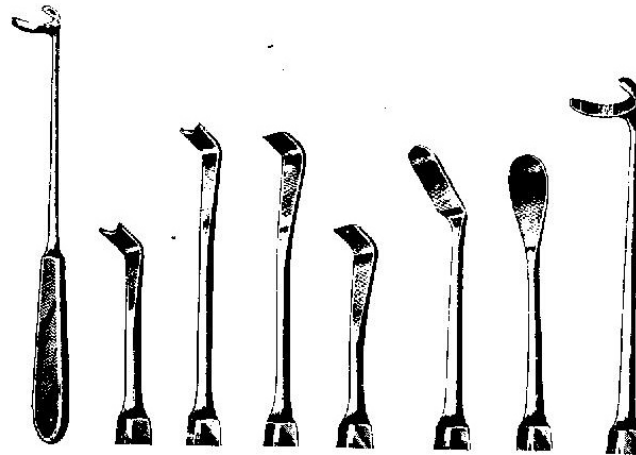

SEMB
29-360 29-361 29-362 29-363 29-364 29-365 29-366

BONE SURGERY

LEVERS

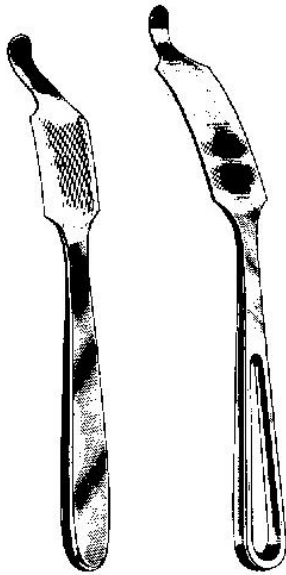

LANGE-HOHMANN
29-370 27 cm 29-380
29-372 29 cm 29-382

LEVERS AND FORCEPS



29-390

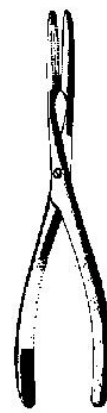

SEQUESTRUM
29-390 20 cm
29-392 20 cm



29-392

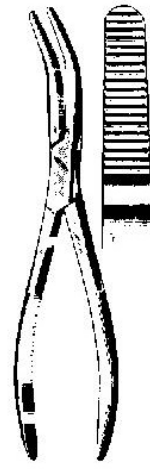

VAN BUREN
29-400 23 cm

BONE HOLDING FORCEPS



FERGUSSON
29-405 21 cm



LAGENBECK
29-410 21 cm



SEMB
29-420 19 cm



FARABEU
29-430 23 cm
29-432 26 cm

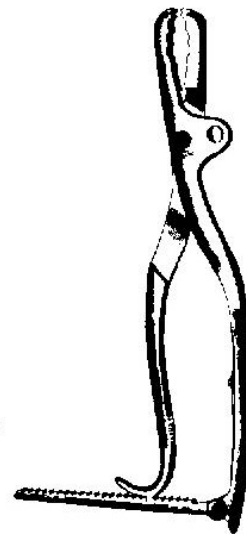

FARABEU-F.LAMBOTTE
29-440 26cm



BONE SURGERY
BONE HOLDING FORCEPS



LANE
29-450 31.5 cm
29-452 39 cm

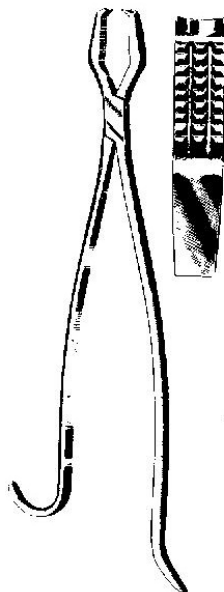

LANE
29-460 33 cm
29-462 45 cm

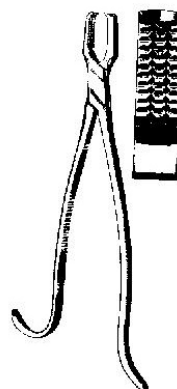

KERN
29-470 17 cm
29-472 21 cm



KERN
29-480 17 cm
29-482 21 cm

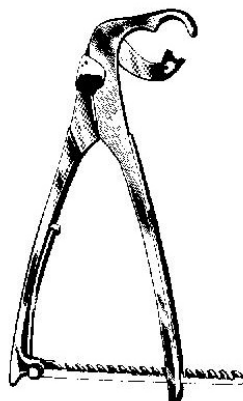

LAMBOTTE
29-490 19 cm
29-492 23 cm
29-494 26 cm

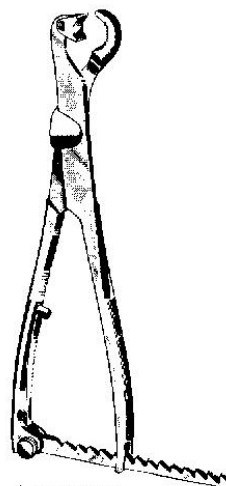

LAMBOTTE
29-500 22 cm
29-502 26 cm
29-504 33 cm

BONE SURGERY

RETRACTOR

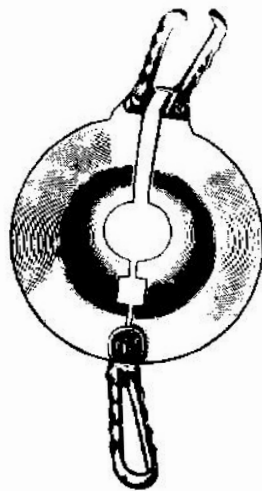

PERCY
29-510

BONE RONGER

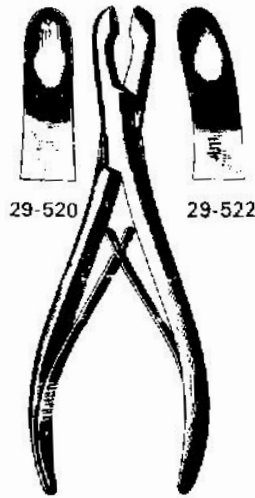

29-520 29-522

LUER
29-520 17 cm
29-522 17 cm



LEMPERT
29-530 19 cm

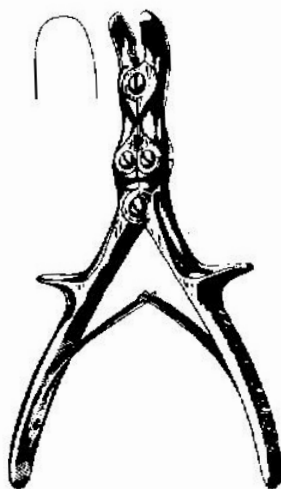

STILLE-LUER
29-540 22 cm

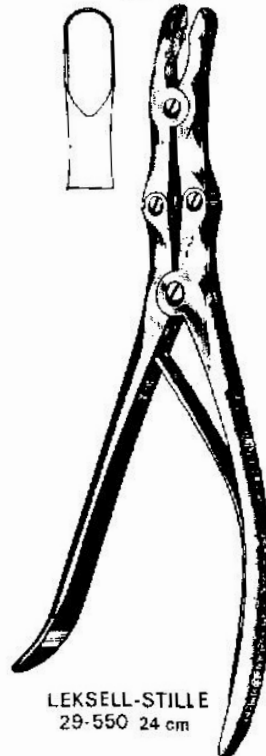

LEKSELL-STILLE
29-550 24 cm

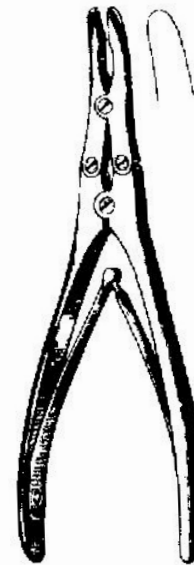

RUSKIN
29-560 18 cm



BONE SURGERY

BONE RONGEUR

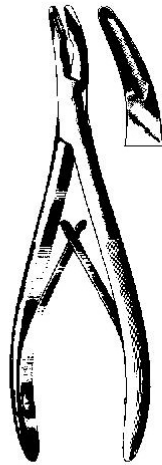

HARTMAN
29-570 18.5cm

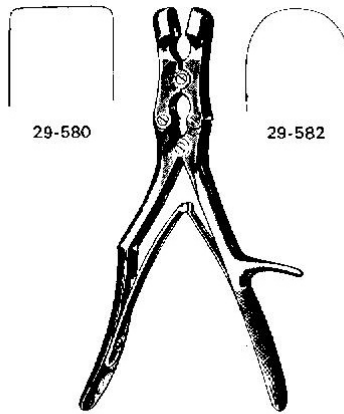

SAUERBRUCH
29-580 30cm
29-582 30cm

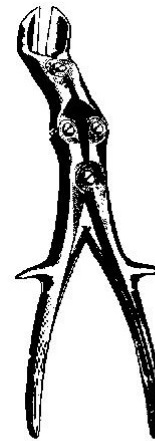

LISTON-KEY
29-590 27cm

BONE CUTTING FORCEPS



29-600

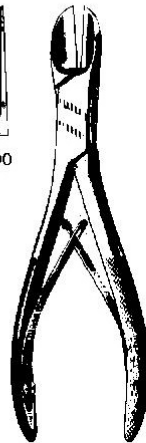

LISTON
STR CUR
29-600 14cm 29-610
29-602 17cm 29-612
29-604 19cm 29-614
29-606 22cm 29-616



29-610

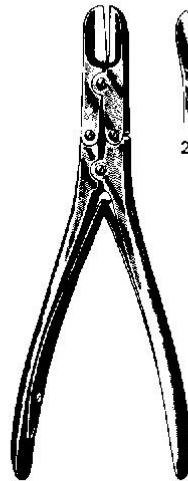

RUSKIN-LISTON
29-620 18cm
29-622 18cm



29-622

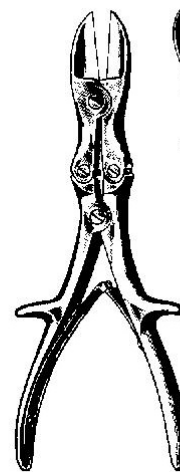

STILLE-LISTON
29-630 27cm
29-632 27cm



29-632

LUNG SURGERY

RIB SHEARS



31-100 20cm
31-102 23cm



COLLIN
31-120 19cm

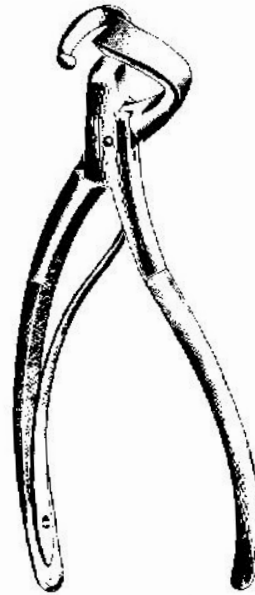

DOYEN
31-130 19cm

RIB SHEARS

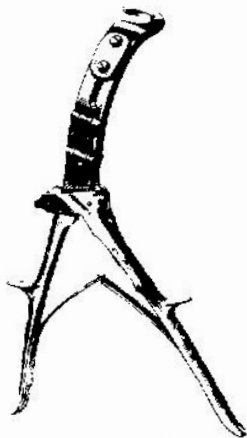

BRUNNER
31-140 28cm

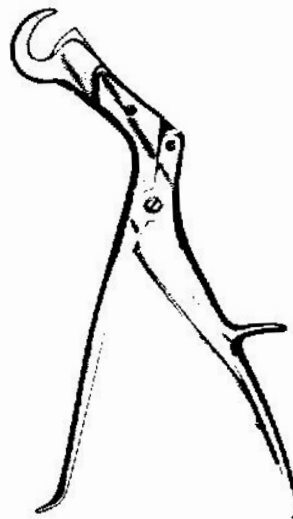

GIERTZ-STILLE
31-150 36cm

SPREADER

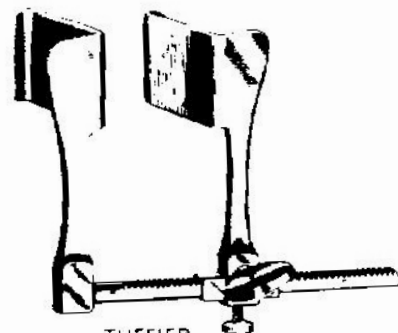

TUFFIER
31-160

CARDIOVASCULAR

BRONCHUS

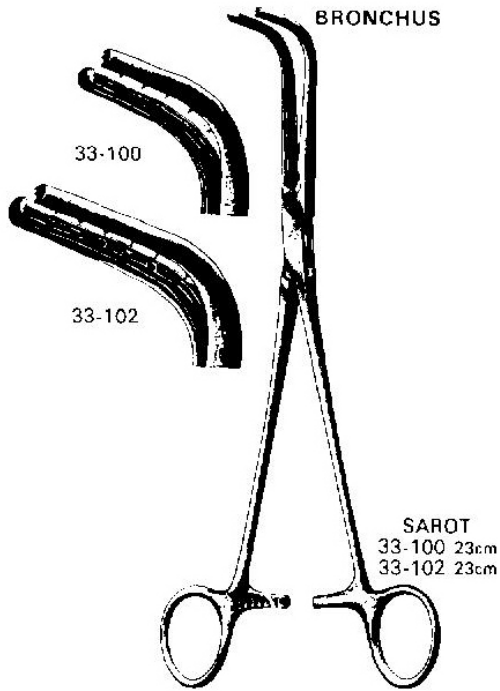

ANASTOMOSIS

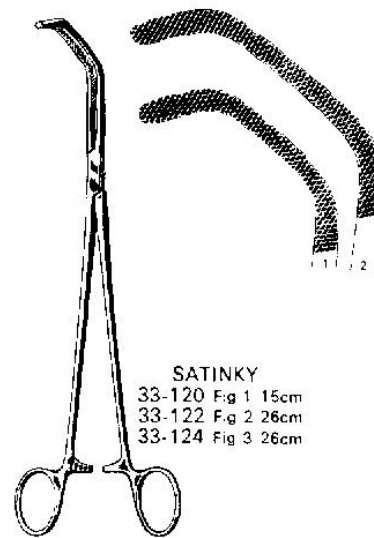

ANASTOMOSIS

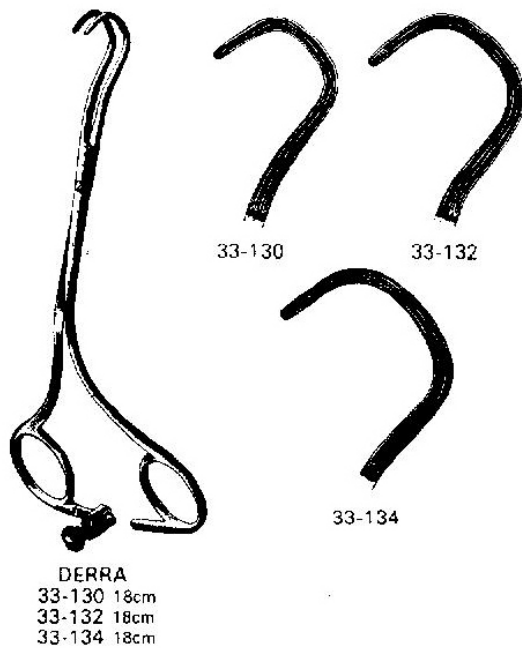

BRONCHUS

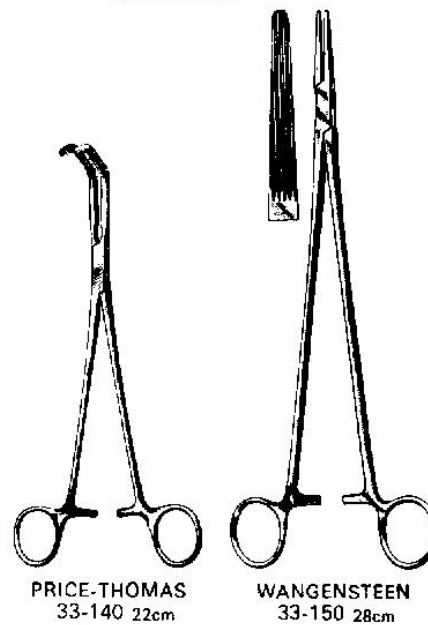

**CARDIOVASCULAR
LUNG GRASPING**

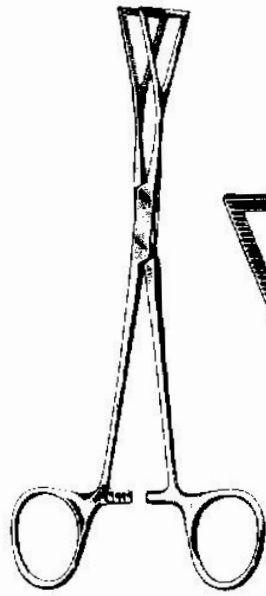

LOVELACE
33-160 20cm



LOVELACE
33-170 20cm

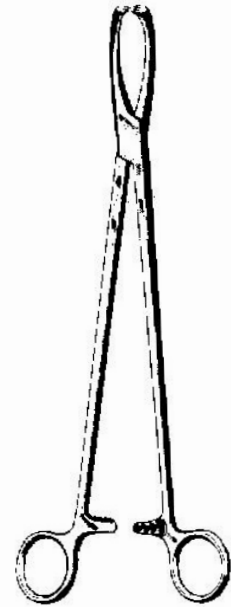

HARRINGTON-ROCHESTER
33-180 30cm



DAVIDSON
33-190 23cm

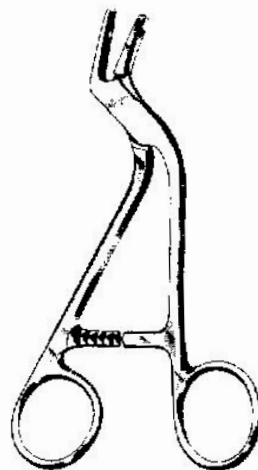

ADSON
33-200 15cm

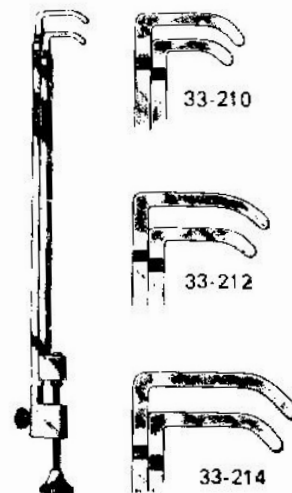

BLALOCK
33-210 15cm
33-212 20cm
33-214 20cm

NEUROSURGERY

BRAIN CLAMPS SUCTION CANNULA

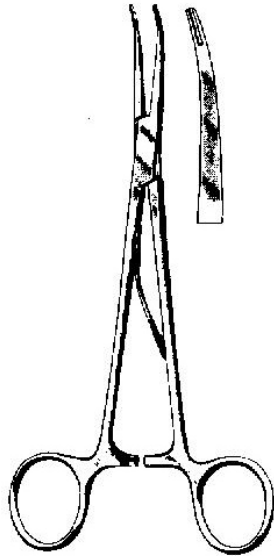

McKENZIE
35-100 15cm
35-102 19cm

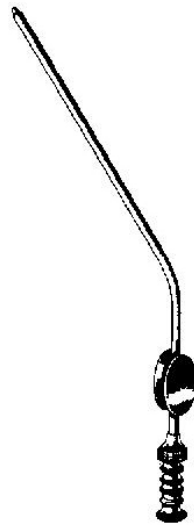

FRAZIER 17cm
35-110 6 ch.G.
35-112 8 ch.G.
35-114 10 ch.G.
35-116 12 ch.G.

FRAZIER 35-120 13cm
35-122 17cm

NERVE HOOK



GRAHAM 35-130 16.5cm
SACHS 35-140 16.5cm

LAMINECTOMY RONGEURS

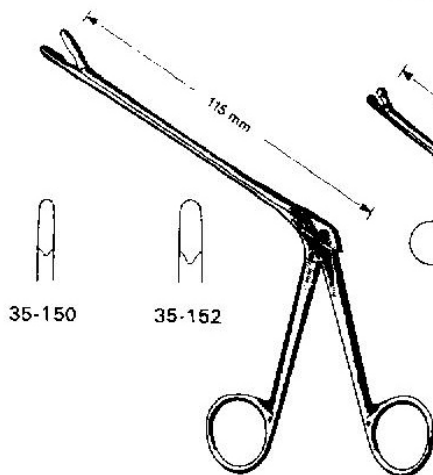

35-150

35-152

SPURLING-LOVE
35-150 28cm
35-152 28cm

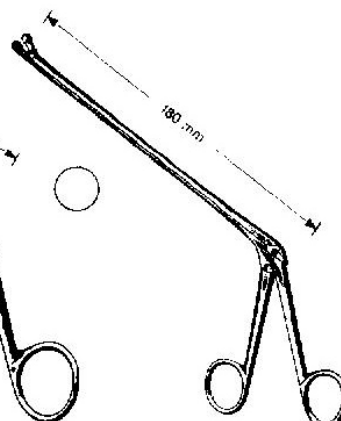

OLDBERG
35-160 25cm

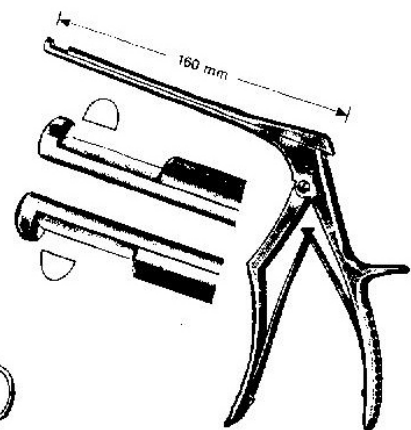

COLCLOUGH
35-170 27cm UP CUTTING
35-172 27cm DOWN CUTTING

OPHTHALMOLOGY
EYE SPECULA



BOWMAN
37-100 7cm

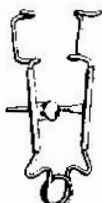

CRITCHETT
37-120 6cm



SMITH
37-130 5cm



CLARKE
37-140 8cm



GRAEFE
37-150 6cm
37-152 8cm

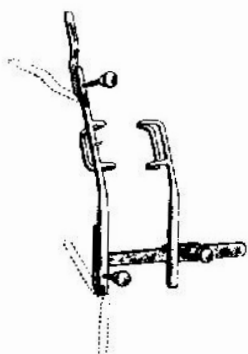

ARRUGA
37-160 7cm L
37-162 7cm R

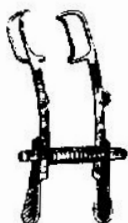

MELLINGER
37-170 7cm



MUELLER
37-180 7cm

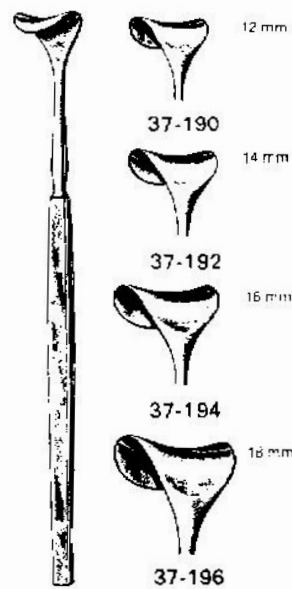

DESMARRES
37-190 12mm
37-192 14mm
37-194 16mm
37-196 18mm

OPHTHALMOLOGY

SCALPELS

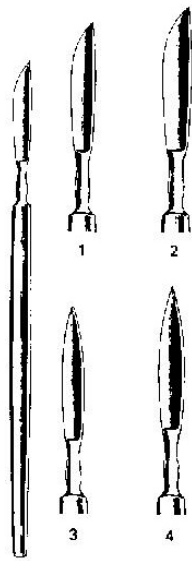

37-200 Fig 1
37-202 Fig 2
37-204 Fig 3
37-206 Fig 4



BEER
37-220 Fig 1
37-222 Fig 2

KNIVES

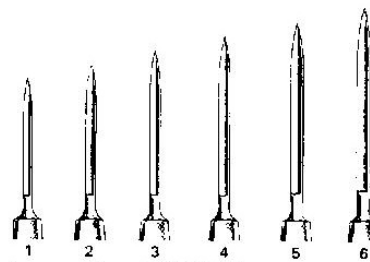

CATARACT
37-210 Fig 1
37-211 Fig 2
37-212 Fig 3
37-213 Fig 4
37-214 Fig 5
37-215 Fig 6

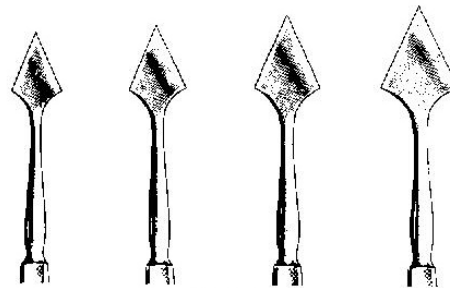

JAEGER
37-230 37-232 37-234 37-236

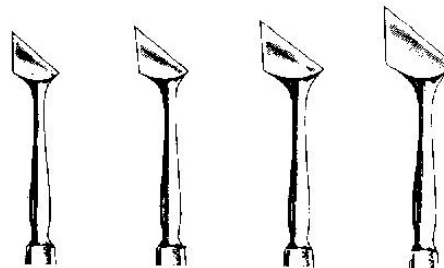

JAEGER
37-240 37-242 37-244 37-246



SURGICAL INSTRUMENTS

OPHTHALMOLOGY

KNIVES

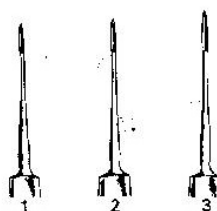

KNAPP
37-250 Fig 1
37-252 Fig 2
37-254 Fig 3

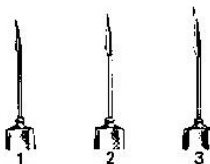

ZIEGLER
37-260 Fig 1
37-262 Fig 2
37-264 Fig 3

NEEDLES

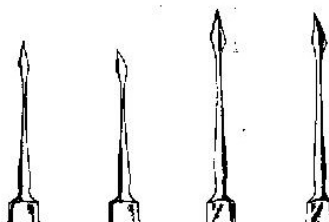

CATARACT **FOREIGN BODY**
37-270 37-272 37-280 37-282

CYSTOTOMES



BOWMANN
37-290 37-292



37-300

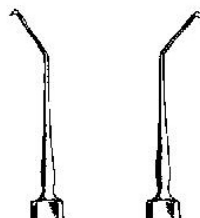

GRAEFE
37-302 37-304

HOOKS



GRAEFE
37-310 37-312



GUTHRIE
37-320 37-322

SCOOPS

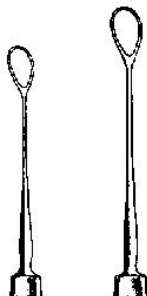

WEBER
37-330 37-332



SNELLEN
37-340

SPOONS

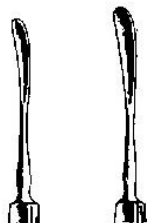

DAVIEL
37-350 37-352

RETRACTORS

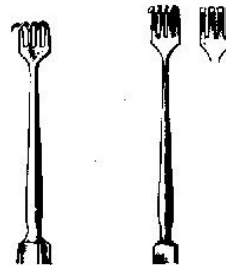

ROLLET **KNAPP**
37-360 37-370



OPHTHALMOLOGY

HOOKS

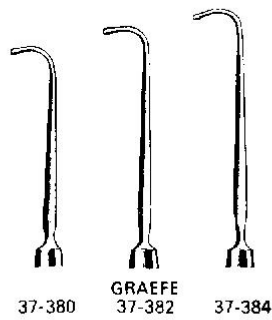

37-380 **GRAEFE** 37-382 37-384

SCOOP

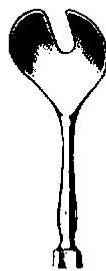

WELLS
37-390

SPATULAS

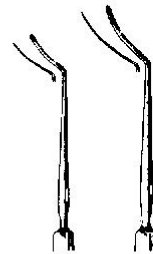

CASTROVIJO
37-400 37-402

CURETTES



WECKER
37-410 37-412

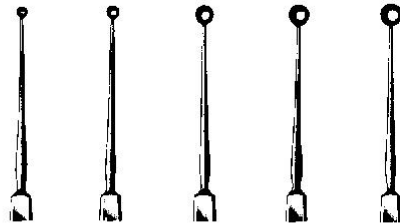

MEYHOEFER
37-420 37-422 37-424 37-426 37-428

CHISEL



ROLLET
37-430

FOREIGN BODY



WALTON 37-440 **DIX** 37-450



JAEGER
37-460

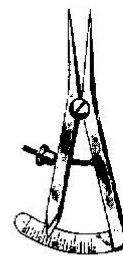

CASTROVIJO
37-470



SURGICAL INSTRUMENTS

OPHTHALMOLOGY

DILATORS

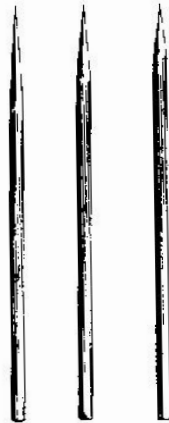

WILDER
37-480 Fig 1
37-482 Fig 2
37-484 Fig 3

PROBES

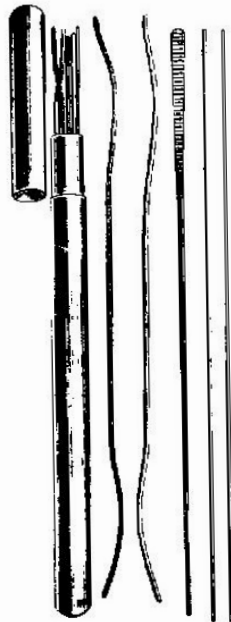

BOWMAN
37-490 SET

DISSECTOR



AXENFELD
37-500

SPATULAS



WHEELER
37-510



SMITH-FISHER
37-520



74 37-530



37-540



MEYHOEFER
37-550



37-560



37-570



37-580



37-590



37-600



OPHTHALMOLOGY
IRIS FORCEPS



37-610



37-611



37-612



1:2
37-613



1:2
37-614



1:2
37-615

GRAEFE
SERRATED 1:2
37-610 10cm 37-613
37-611 10cm 37-614
37-612 10cm 37-615



GRAEFE
STR
37-620



CUR
7cm 37-622



1:2
STR
37-630



GRAEFE 1:2
CUR
7cm 37-632



BISHOP-HARMAN
SERRATED 1:2
37-640 8.5cm



1:2
37-642



1:2 HESS
37-670 7cm



1:2
37-680



OPHTHALMOLOGY



1:2
HESS
37-690 9cm 37-700



IRIS FORCEPS



1:2
FISCHER
37-710 7cm



ARRUGA
37-730 9.5cm



ELSCHING
37-740 10cm

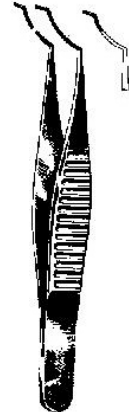

CAPSULAR FORCEPS

HESS
37-750 6.5cm

FIXATION FORCEPS



-760 6cm



FUCHS
37-770 7cm



HESS
37-780 6cm



1:2
ELSCHING
37-790 11cm



GRAEFE
37-800 11cm



GRAEFE
37-810 11cm

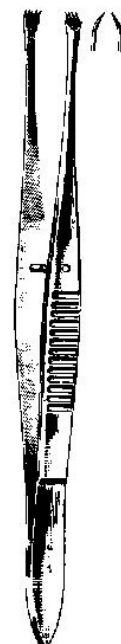

SCHMIDT-RIMPLEX
37-820 11cm

OPHTHALMOLOGY

SUTURES AND CHALAZIAN FORCEPS

SUTURE FORCEPS

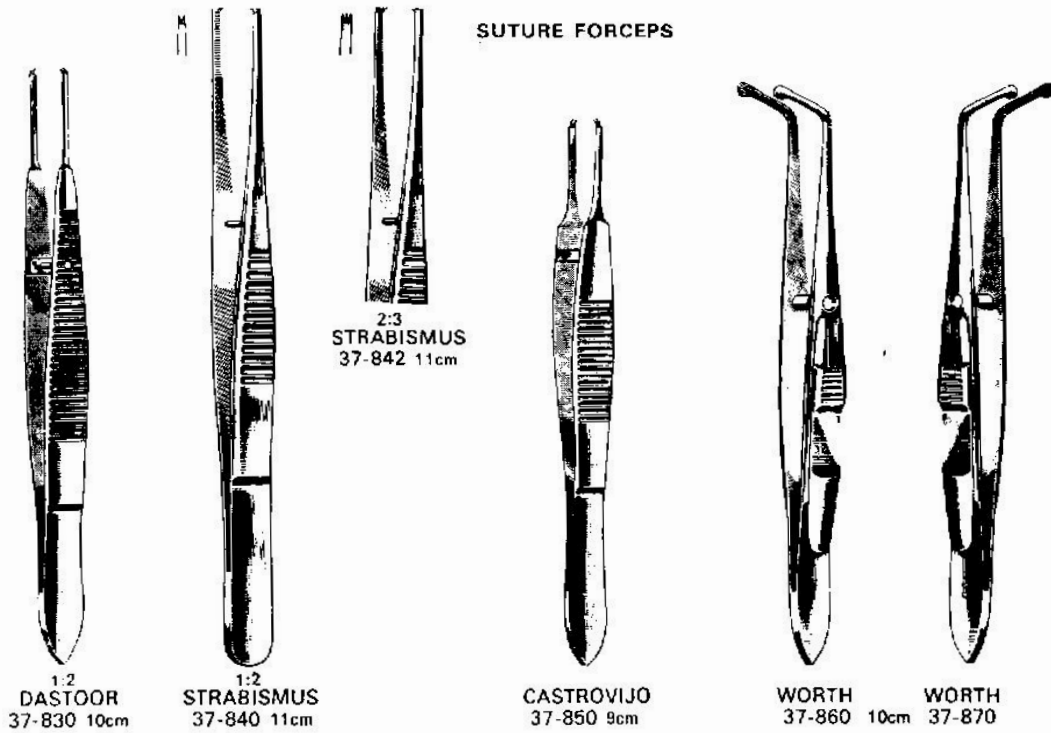

CHALAZIAN FORCEPS

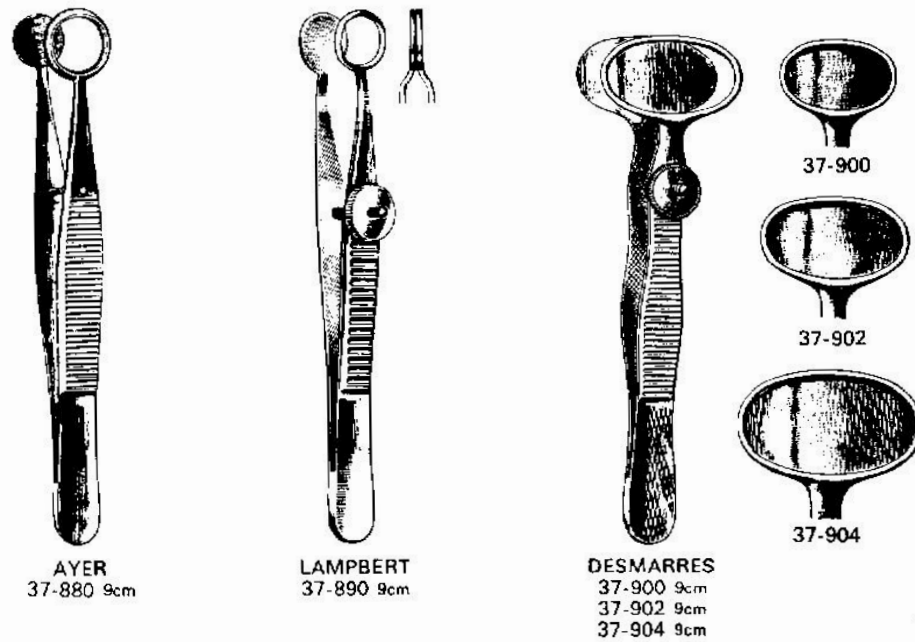



OPHTHALMOLOGY
ENTROPIUM FORCEPS

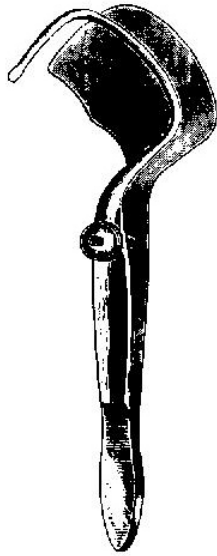

SNELLEN
37-910 R
37-912 L

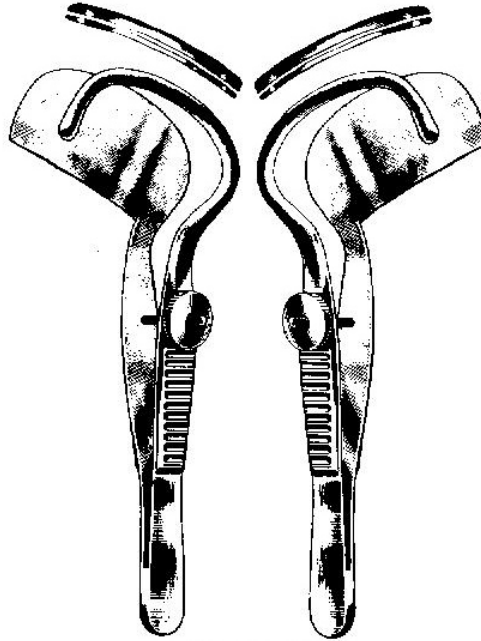

DESMARRES
37-920 10cm 37-922

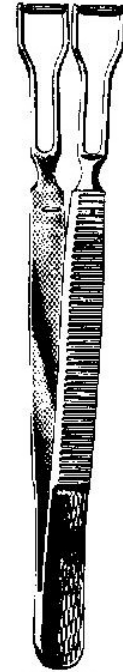

KNAPP
37-930 11cm

IRIS AND TENOTOMY SCISSORS

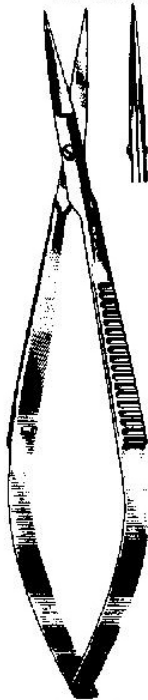

NOYES
37-940 12cm
37-942 12cm
37-944 12cm



1
37-940

2
37-942

3
37-944



WECKER
37-950 11cm
37-952 11cm
37-954 11cm



37-950

37-952

37-954

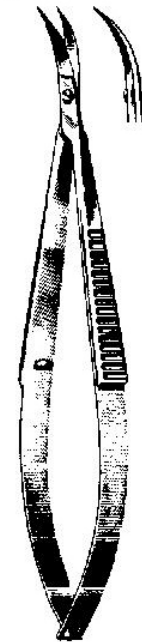

CASTROVIHO
37-960 10cm

OTOLOGY

EAR SPECULA



HARTMAN
39-100

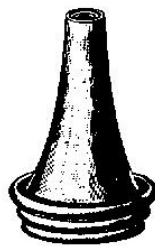

TOYNBEE
39-110



GRUBER
39-120

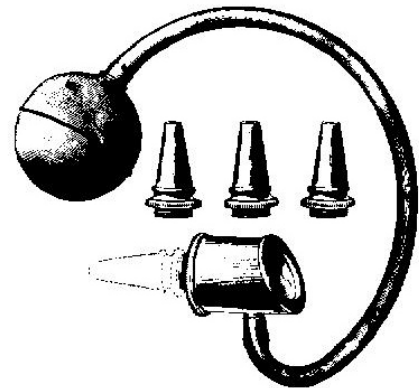

SIEGLE
39-130

PNEUMATIC SYRINGE

- 39-140 50cc
- 39-142 75cc
- 39-144 100cc
- 39-146 150cc

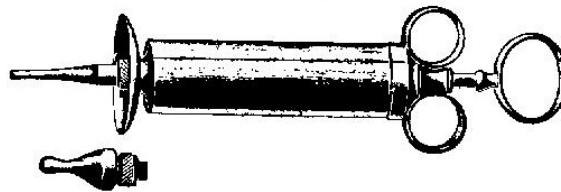

CATHETERS

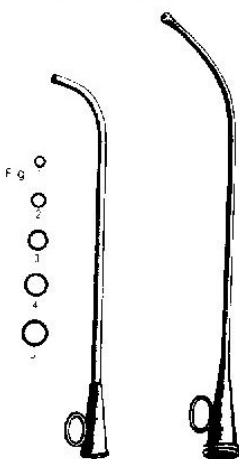

LUCAE
39-150
Fig 0 to 5

WOAKES
39-160

PERFORATORS

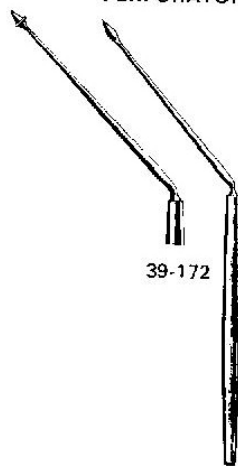

39-172

TROELTSCH
39-170
39-172

CURETTES

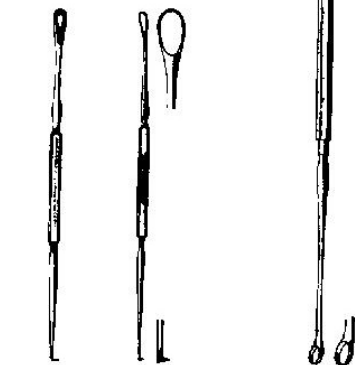

GROSS
39-180 39-190

BARKER
39-200



SURGICAL INSTRUMENTS

OTOLOGY

POLYPUS SNARES

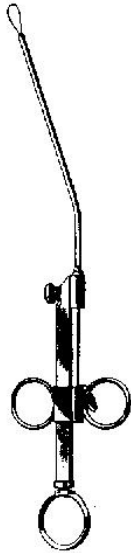

KRAUSE
39-210

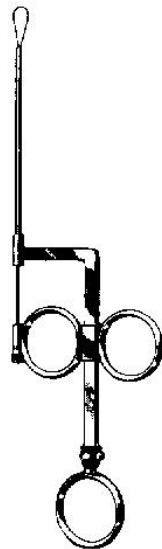

WILDE
39-220

EAR DERESSING FORCEPS

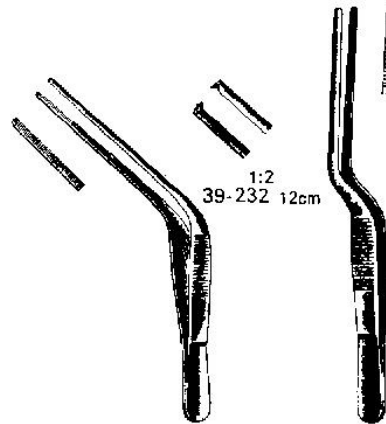

39-230 12cm

1:2
39-232 12cm

39-240 14cm

POLYPUS & FOREIGN BODY FORCEPS

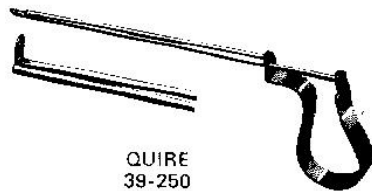

QUIRE
39-250

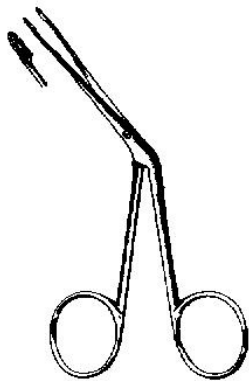

80

HARTMANN
39-260 12cm

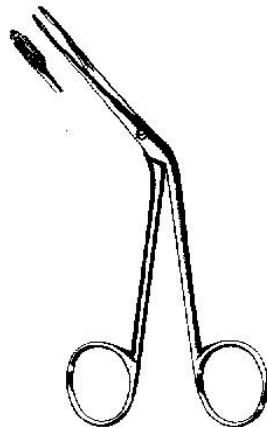

HARTMANN
39-270 14cm

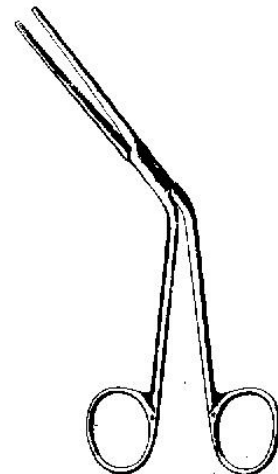

YANKAUER
39-280 15cm



OTOLOGY
EAR FORCEPS

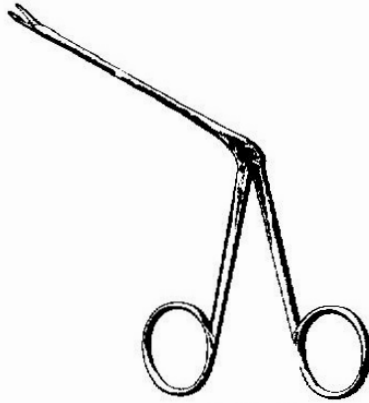

HARTMANN



39-290 8.5cm
39-291 14cm
39-292 16.5cm

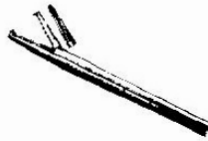

39-293 8.5cm
39-294 14cm



39-295 8.5cm



39-296 8.5cm



39-297 8.5cm

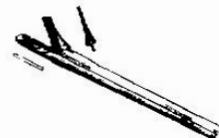

39-298 8.5cm



39-299 8.5cm



39-300 8.5cm

39-290 8.5cm
39-291 14cm
39-292 10.5cm
39-293 8.5cm
39-294 14cm
39-300 8.5cm

39-295 8.5cm
39-296 8.5cm
39-297 8.5cm
39-298 8.5cm
39-299 8.5cm

RHINOLOGY
NAZAL SPECULA

NAZAL SPECULA



VIENNA
41-100 ADULT
41-102 CHILD
41-104 INFANT

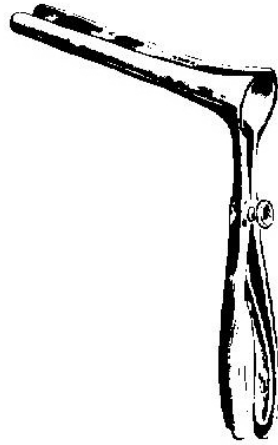

KILLIAN
41-110 Fig 1
41-112 Fig 2
41-414 Fig 3
41-416 Fig 4

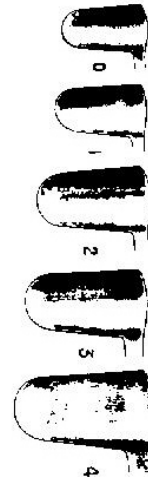

THUDICHUM
41-120 Fig 0
41-122 Fig 1
41-124 Fig 2
41-126 Fig 3
41-128 Fig 4

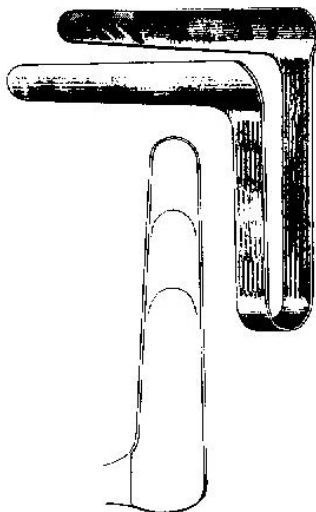
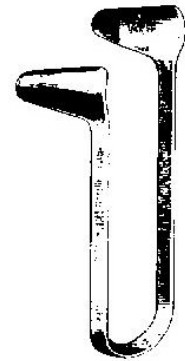

ST-CLAIR THOMSON
41-130 Fig 1
41-132 Fig 2
41-134 Fig 3

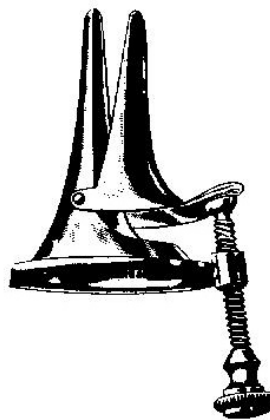
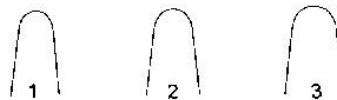

VOLTOLINI
41-140 Fig 1
41-142 Fig 2
41-144 Fig 3

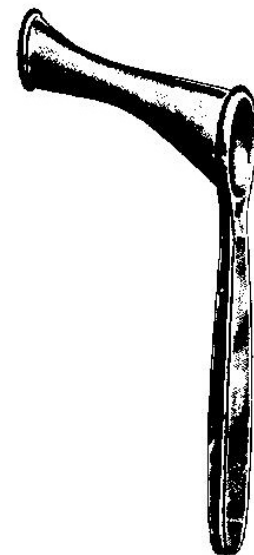

YANKAUER
41-150 19cm



RHINOLOGY

NAZAL SNARE

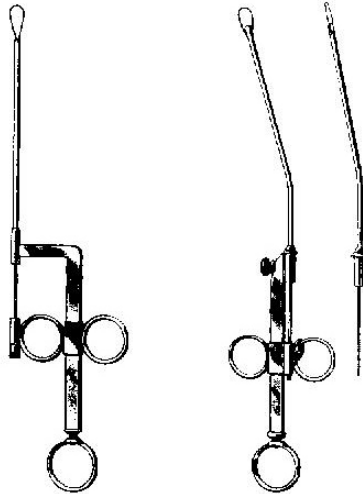

KRAUSE
41-160

KRAUSE-VOSS
41-170

NAZAL DRESSING FORCEPS

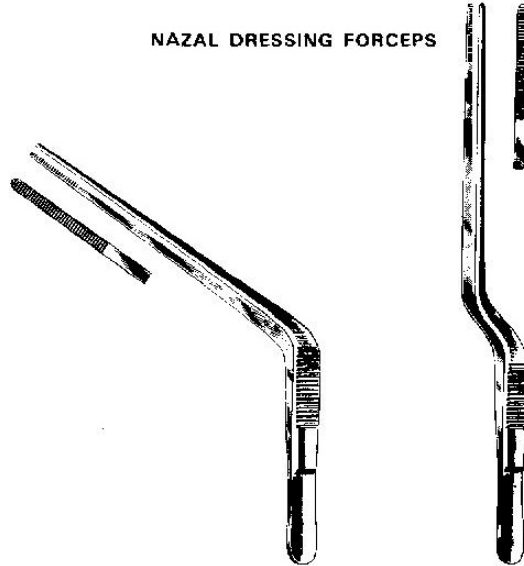

TROELTSCH
41-180 18cm

JANSEN
41-190 20cm

NAZAL DRESSING FORCEPS

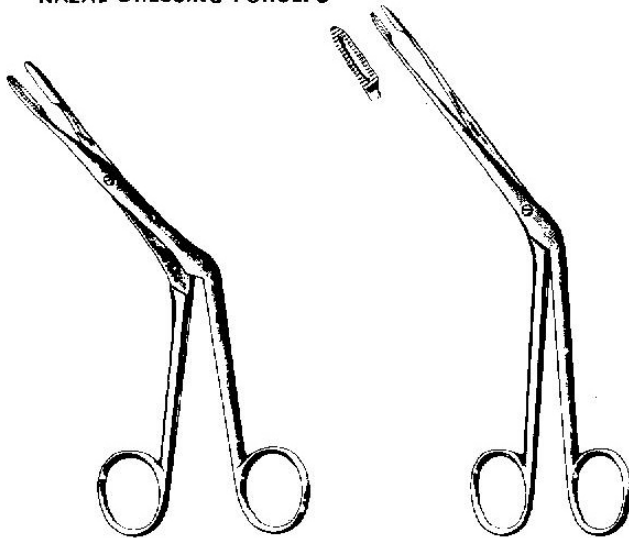

HEYMANN-KNIGHT
41-200 18cm

HARTMAN
41-210 20cm

NAZAL CUTTING FORCEPS

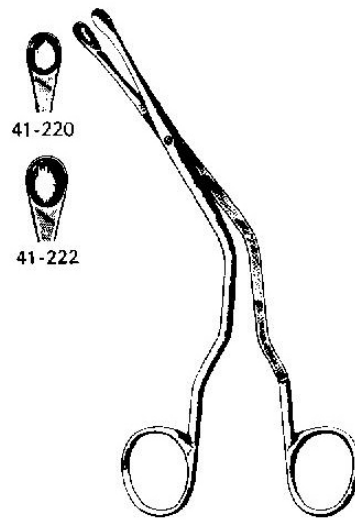

41-220

41-222

LUC
41-220 20cm
41-222 20cm

RHINOLOGY
NAZAL CUTTING FORCEPS

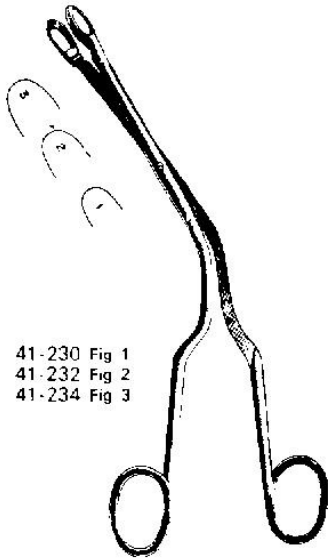

41-230 Fig 1
41-232 Fig 2
41-234 Fig 3

LUC
20cm



41-240
41-242
41-244
41-246

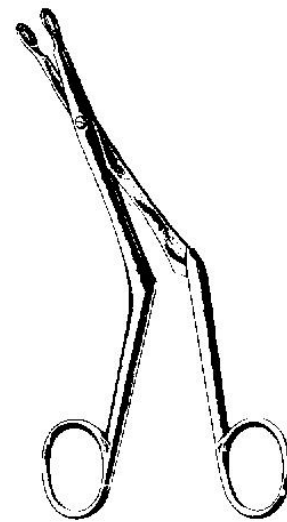

BRUENING
41-240 20cm
41-242 20cm
41-244 20cm
41-246 20cm

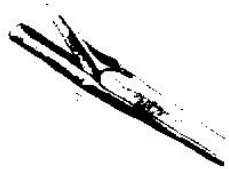

STRUYCKEN
41-250

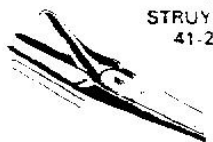

STRUYCKEN
41-251



HASEK
41-252



MYLES
41-253



HARTMANN
41-254



WEIL
41-255



TAKAHASHI
41-256



TAKAHASHI
41-257

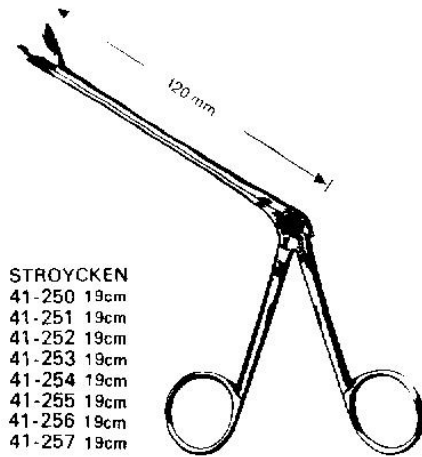
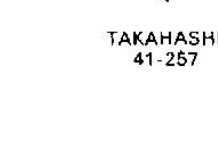

STROYCKEN
41-250 19cm
41-251 19cm
41-252 19cm
41-253 19cm
41-254 19cm
41-255 19cm
41-256 19cm
41-257 19cm

RHINOLOGY
NAZAL CUTTING FORCEPS

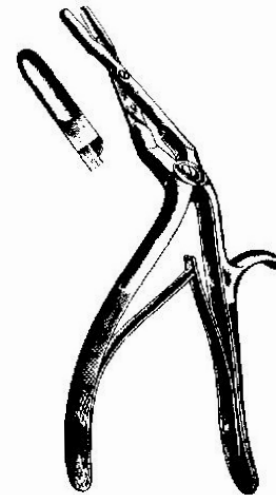
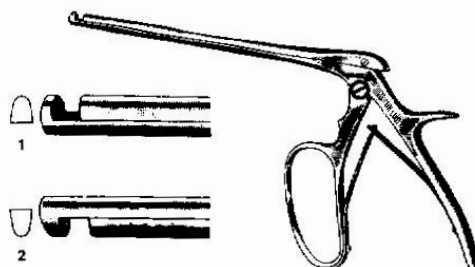
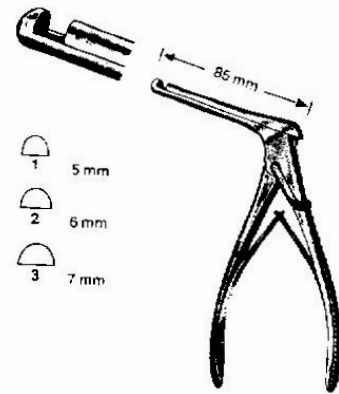
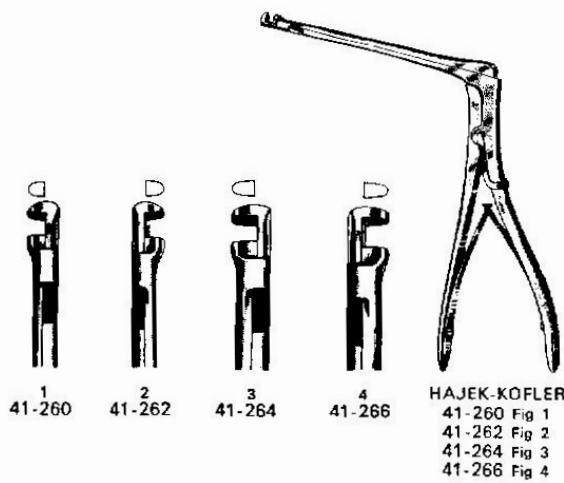



SURGICAL INSTRUMENTS

RHINOLOGY

SEPTUM FORCEPS

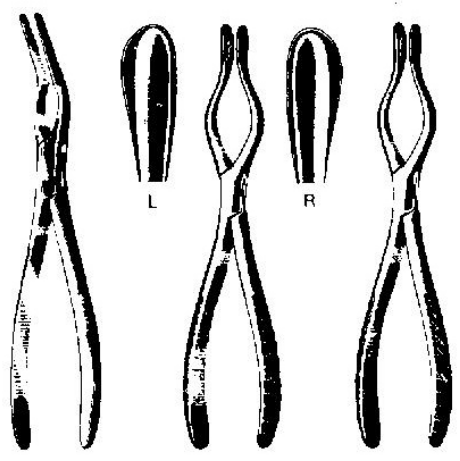

ASCH
41-300 23cm

WALSHAM
41-310 23cm

WALSHAM
41-320 23cm

KNIVES

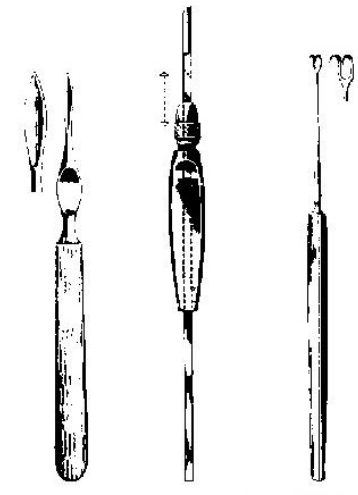

BALLENGER
41-330

BRUENINGS
41-340

FREER
41-350

CURETTES

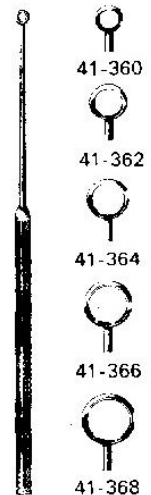

MYLES
41-360 17cm
41-362 17cm
41-364 17cm
41-366 17cm
41-368 17cm

KNIVES

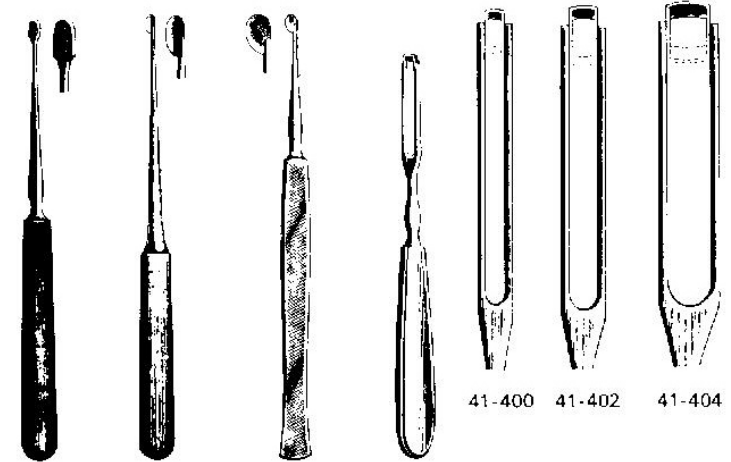

FREER
41-370

FREER
41-380

FREER
41-390

BALLENGER
19cm
41-400 3mm
41-402 4mm
41-404 5mm



RHINOLOGY

ELEVATORS

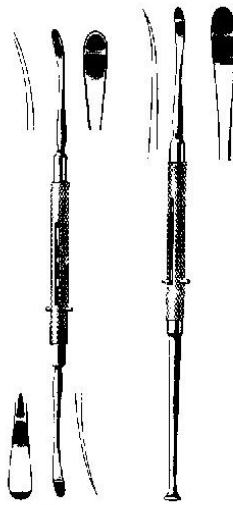

FREER
41-410

FREER
41-420

FREER
41-430 16.5cm

GOUGES



FREER
41-440 4mm
41-442 6mm
41-444 9mm



BALLENGER
16cm



KILLIAN
41-450 5mm

CHISELS



FREER
41-460



FREER
41-470

SINUS CANNULA



EICKEN-KILLIAN
41-480 3mm



KILLIAN
41-490 1.5cm



HARTMANN
41-500

ANTRUM CANNULA

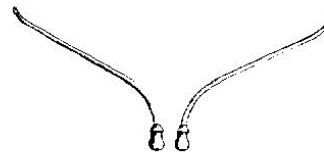

HARTMANN
41-510 2 mm
41-512 2.5mm
41-514 3 mm

RHINOLOGY

ADENOID CURETTE

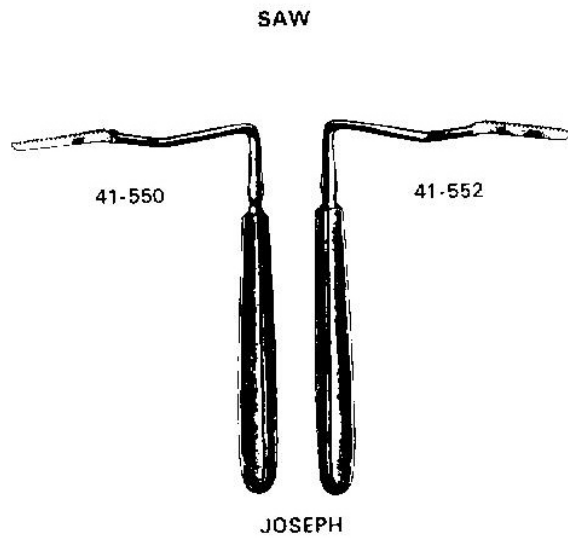
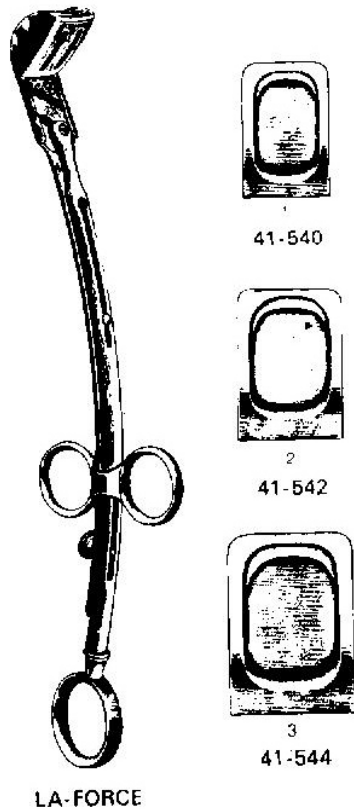
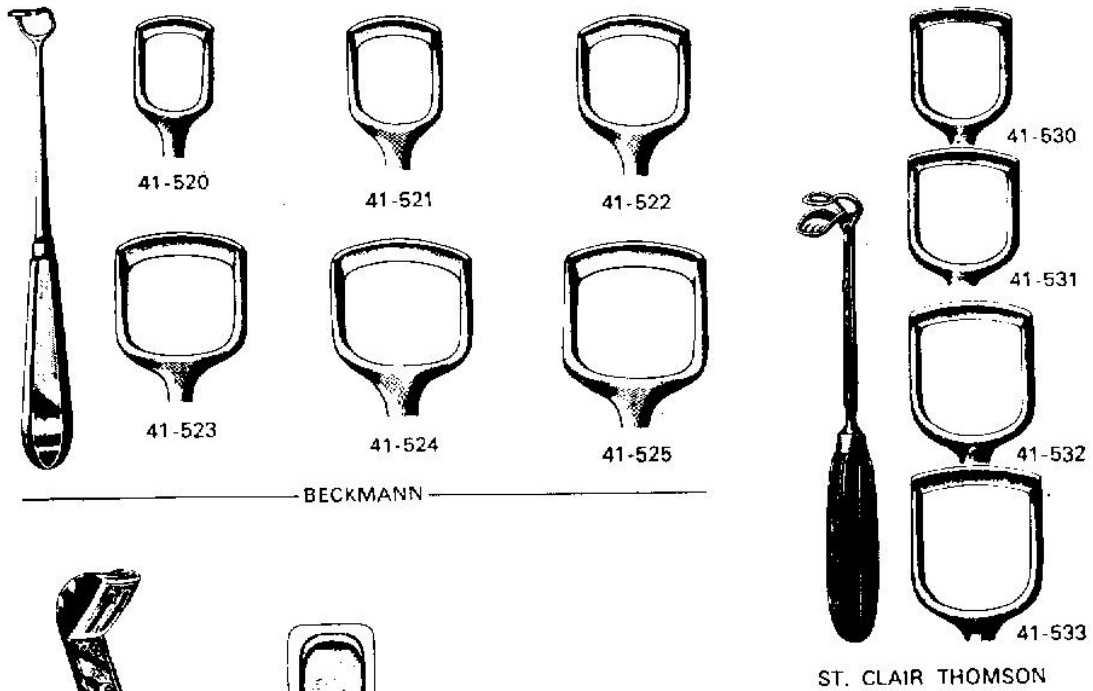



ORAL INSTRUMENTS
MOUTH GAGS

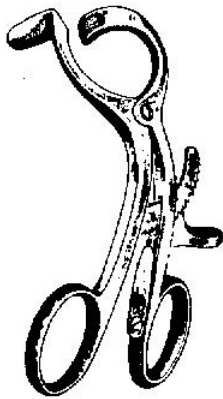

DOYEN
43-100 CHILD
43-102 ADULT

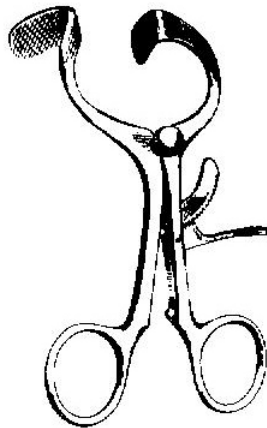

MOLT
43-110 14cm



FURGUSSON
43-120 15cm
43-122 19cm } P.JAWS
43-124 15cm
43-126 19cm } A.JAWS



MASON
43-130 15cm
43-132 19cm } P.JAWS
43-134 15cm
43-136 19cm } A.JAWS

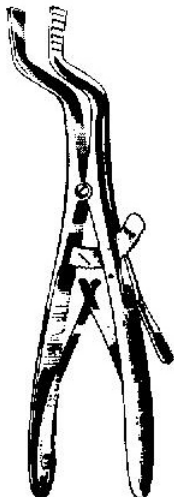

ROSER-KONIG
43-140 16cm
43-142 19cm

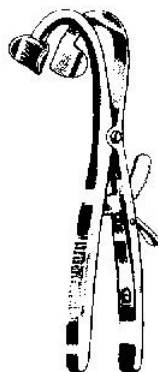

DENHART
43-150 12cm

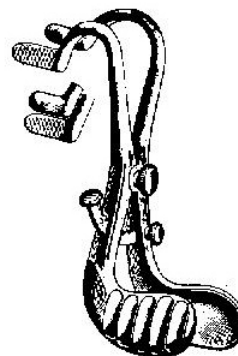

BUXTON
43-160 A.JAWS
43-162 P.JAWS

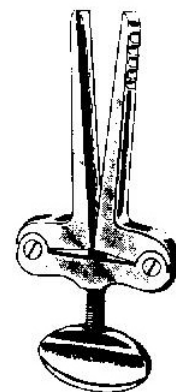

HEISTER
43-170 13cm



ORAL INSTRUMENTS
MOUTH GAGS

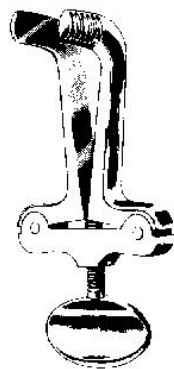

HEISTER
43-180 12cm

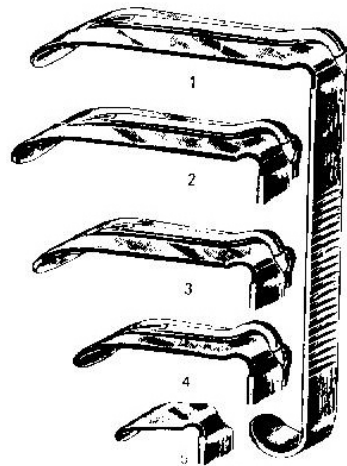

DAVIS-BOYLE
43-190 SET

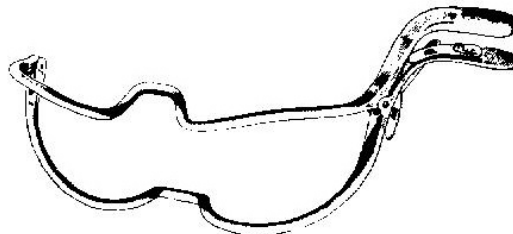
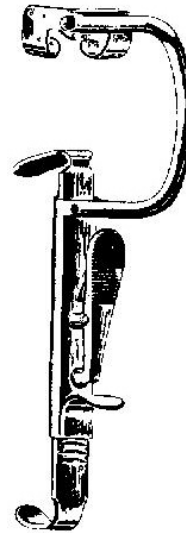

JENNING
43-200 9cm
43-202 11cm
43-204 13cm
43-206 15cm

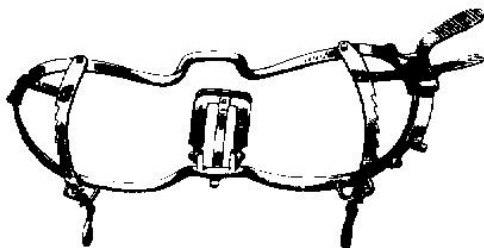

WHITEHEAD
43-210 11cm
43-212 13cm
43-214 15cm

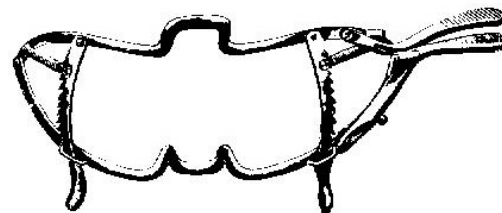

WHITEHEAD
43-220 11cm
43-222 13cm
43-224 15cm



ORAL INSTRUMENTS
TONGUE DEPRESSORS



TOBOLD
43-220 12cm



43-230 14.5cm



BRUENING
43-240 19cm



MAYO
43-250 19cm

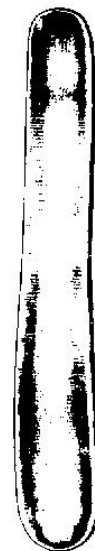

BUCHWALD
43-260 18cm

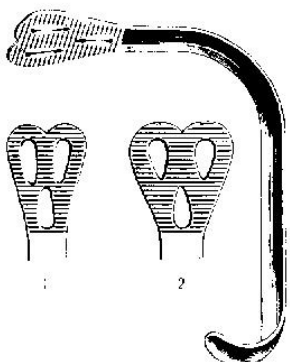

WIEDER
43-270 Fig 1 14cm.
43-272 Fig 2 16cm

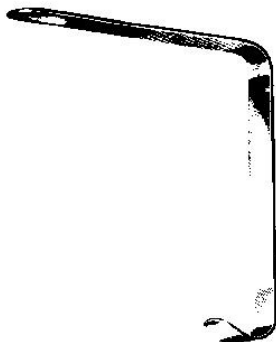

LACK
43-280 CHILD
43-282 ADULT

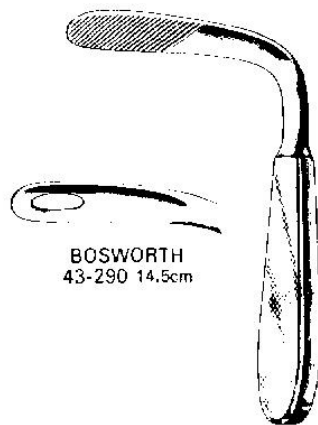

BOSWORTH
43-290 14.5cm

TOBOLD
43-300 14.5cm

ORAL INSTRUMENTS
TONGUE DEPRESSORS

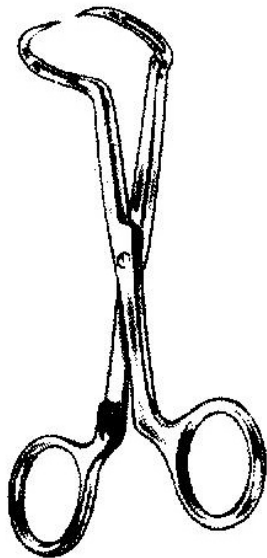

CARMALT
41-310 12.5cm

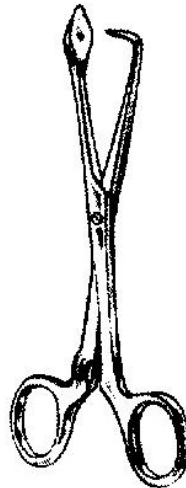

CARBOULD
43-320 14cm

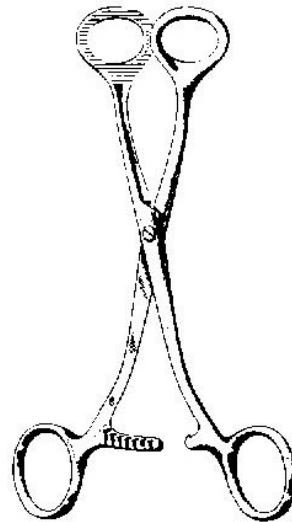

COLLIN
43-330 16cm
43-332 17cm
43-334 19cm

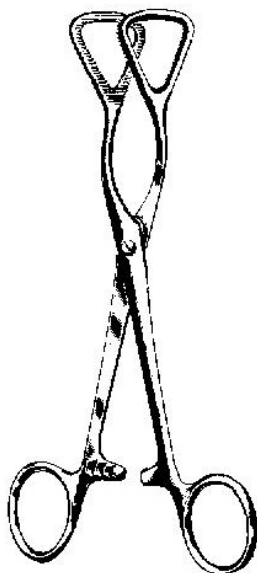

GUY
43-340 19cm



MATHIEU
43-350 19cm

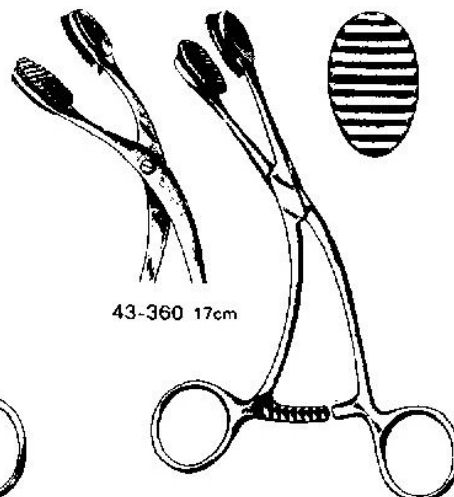

43-360 17cm

YOUNG
43-370 16cm

TONSIL

KNIVES

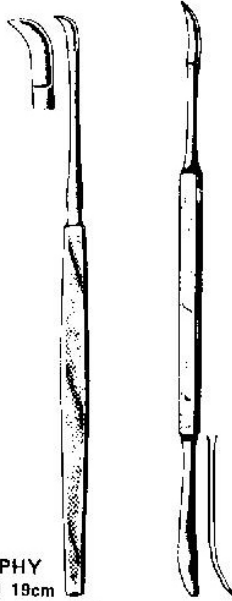

BROPHY
45-100 19cm

LYNCH
45-110 20cm

NEEDLES

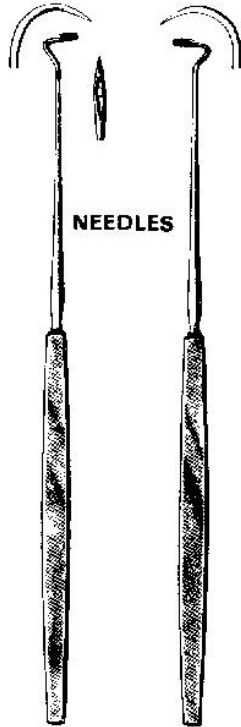

DUPUY-WEISS
45-120 22cm 45-122

HURD
45-130 22.5cm 45-140 21.5cm

DISSECTORS

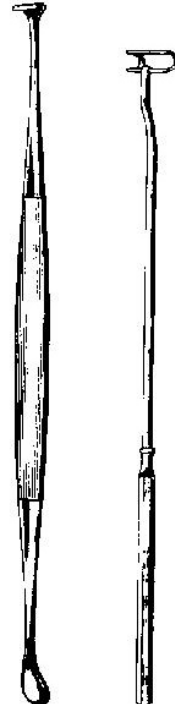

TONSIL FORCEPS

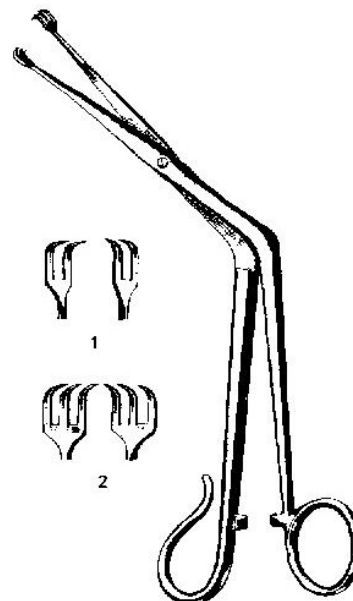

TIVNEN-TYDING
45-150 Fig 1 22cm
45-152 Fig 2 22cm

TONSIL FORCEPS

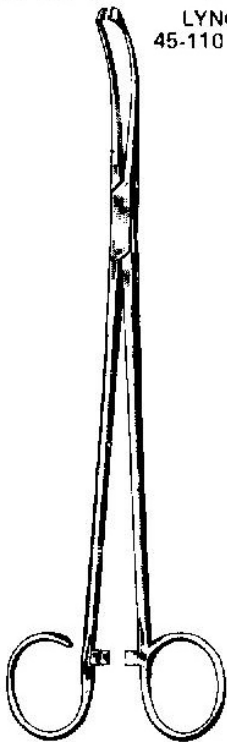

WHITE
45-160 18cm
45-162 23cm

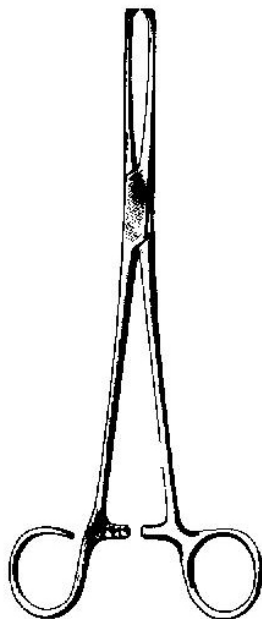

COLVER
45-170 19cm



BALLENGER
45-180 21.5cm

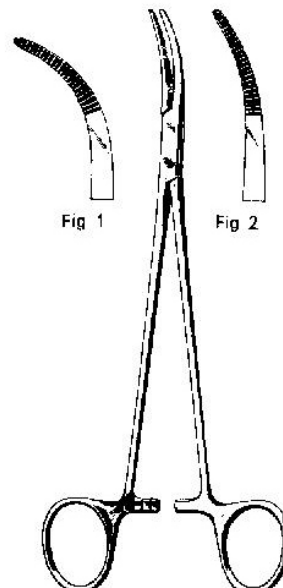

Fig 1

Fig 2

SAWTELL/SCHMIDT
45-190 Fig 1 19cm
45-192 Fig 2 18cm

TONSIL

SNARES

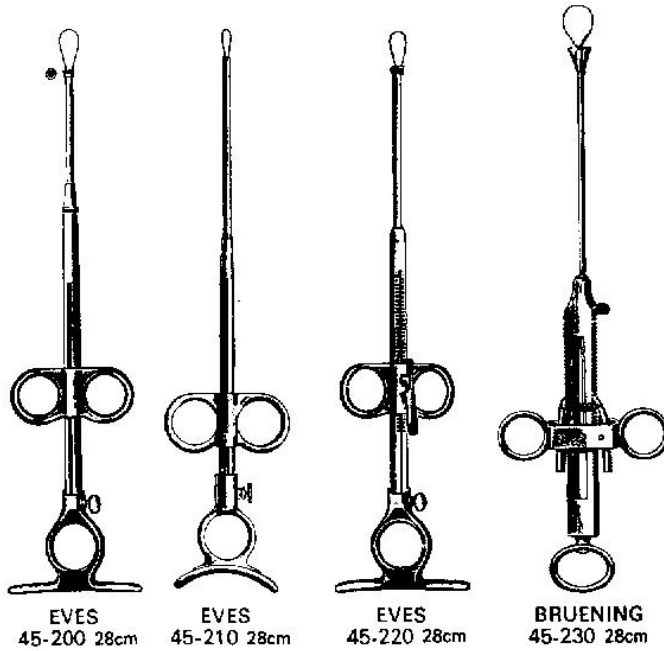

PUNCH FORCEPS

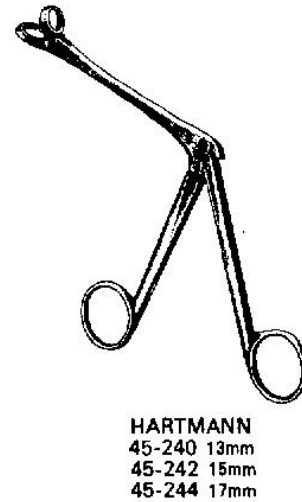

GUILLOTINES

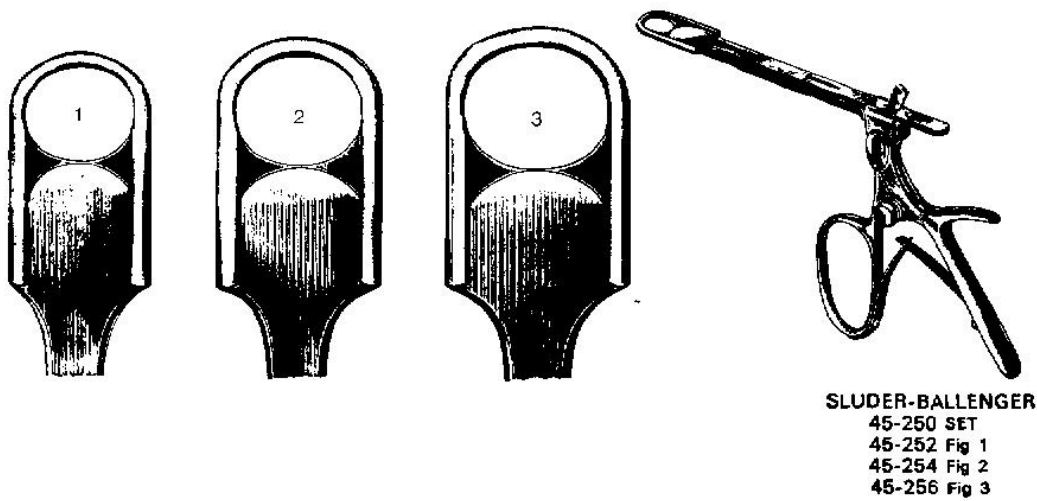

**ESOPHAGOSCOPY
LARYNGEAL FORCEPS**

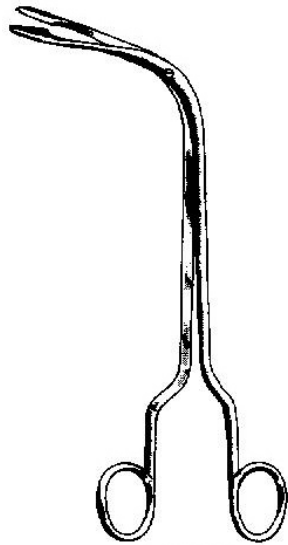

FRAENKEL
47-100 18cm

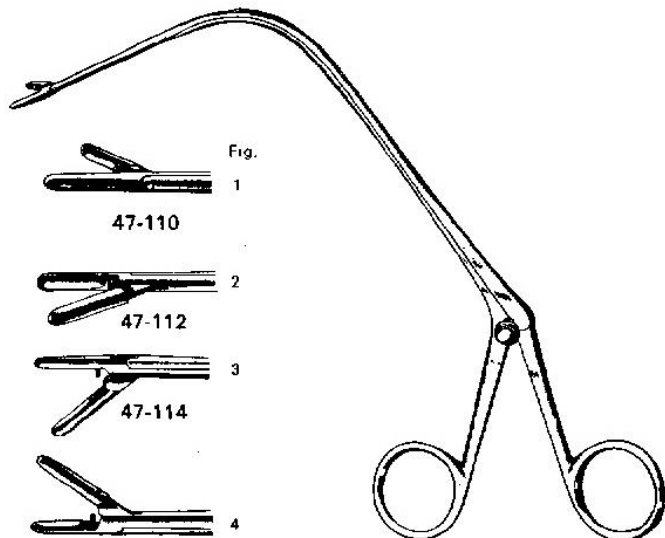

JURASZ
47-110 19cm
47-112 19cm
47-114 19cm
47-116 19cm

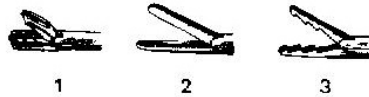
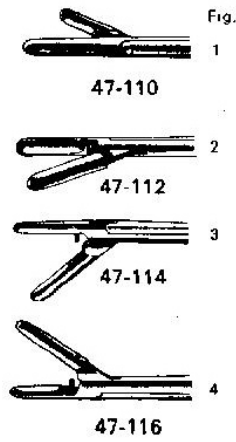

CHEVALIER-JACKSON

	40cm	50cm	60cm
Fig 1	47-120	47-130	47-140
Fig 2	47-121	47-131	47-141
Fig 3	47-122	47-132	47-142
Fig 4	47-123	47-133	47-143
Fig 5	47-124	47-134	47-144
Fig 6	47-125	47-135	47-145
Fig 7	47-126	47-136	47-146

HANDLES

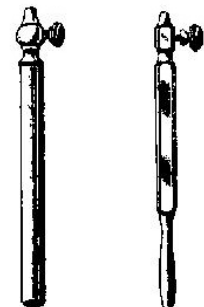

47-150

47-160

TRACHEOTOMY

TRACHEAL HOOKS

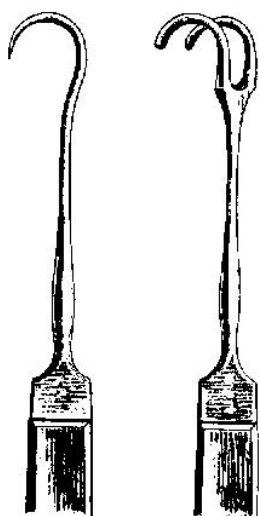

49-100

49-110

DILATING FORCEPS

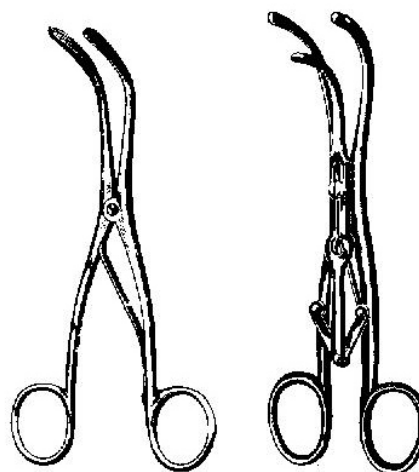

TROUSSEAU
49-120 10.5cm
49-122 14 cm

LABORDE
49-130 14cm

TRACHEAL TUBES

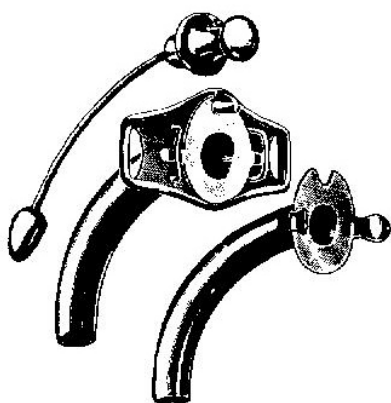

JACKSON
49-140
4 To 13mm



FULLER
49-150
18 To 32 F.G.

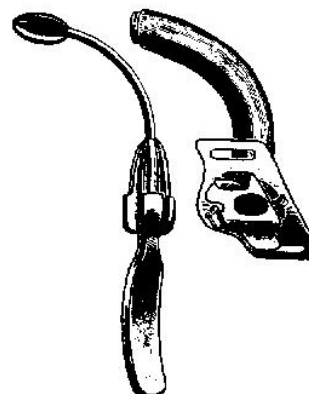

CUBLEY
49-160
18 To 32 F.G.

GOITRE

GOITRE FORCEPS

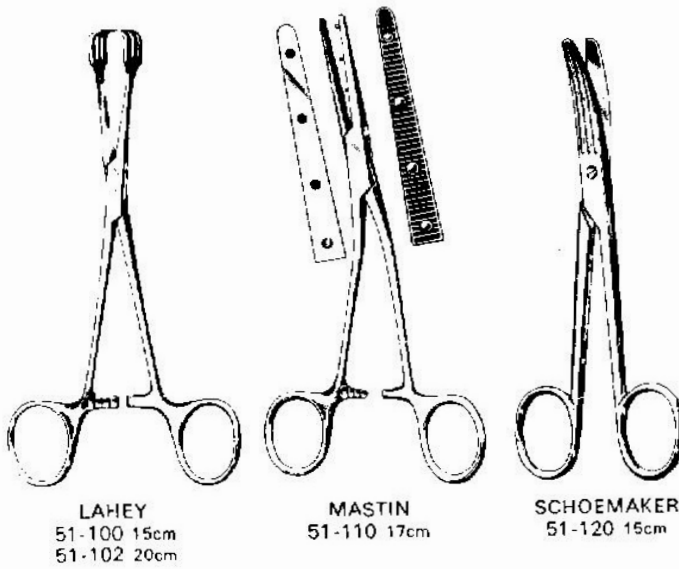

ENACULATORS

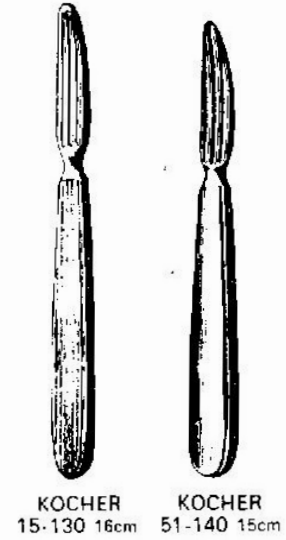

HOOKS

EXTRACTORS

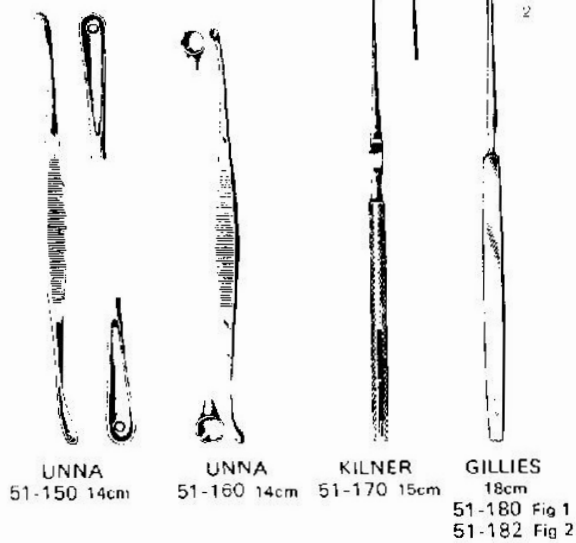

TISSUE FORCEPS

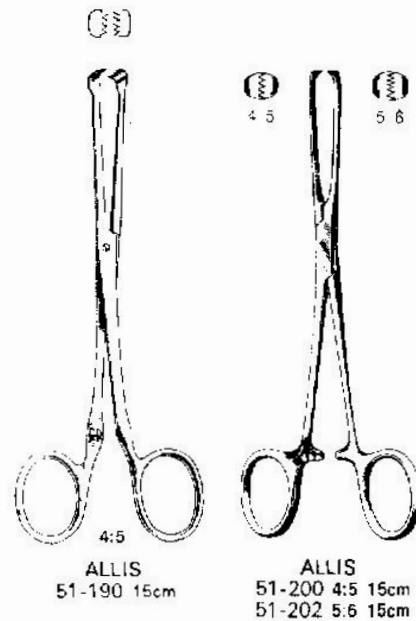

INTESTINES AND STOMACH

INTESTINAL FORCEPS

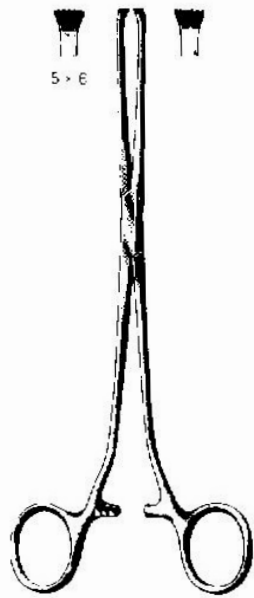

ALLIS
51-210 20cm

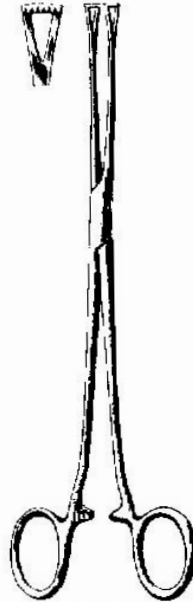

LOCKWOOD
51-220 20cm

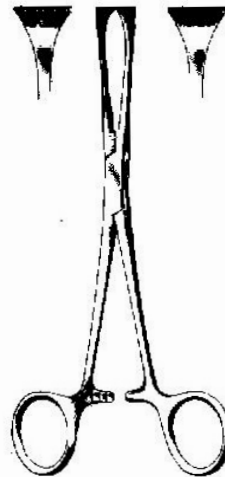

ALLIS-ADAIR
51-230 15.5cm

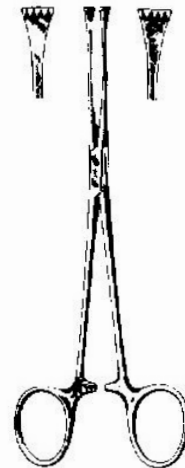

LOCKWOOD-ALLIS
51-240 16cm
51-242 20cm

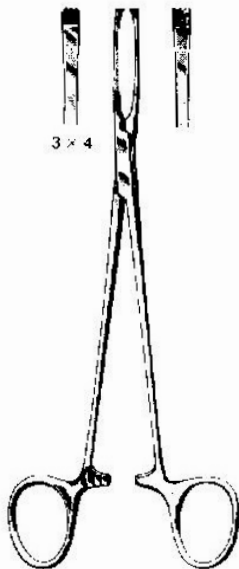

JUDD-ALLIS
51-250 15cm
51-252 19cm

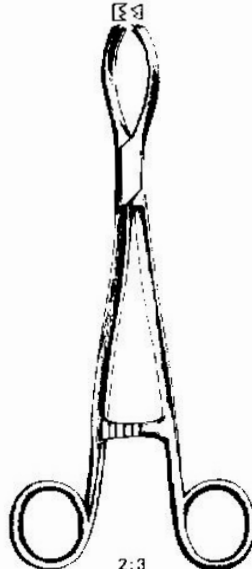

LITTLEWOOD
51-260 19cm



STILLE
51-270 20cm

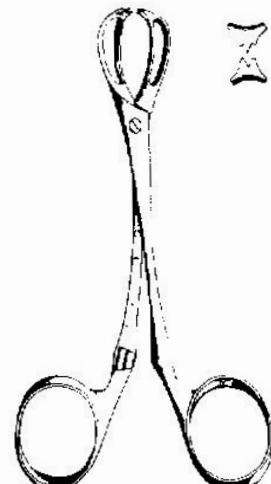

LANE
51-280 12.5cm
51-282 15 cm
51-284 19 cm



INTESTINES AND STOMACH
INTESTINAL FORCEPS

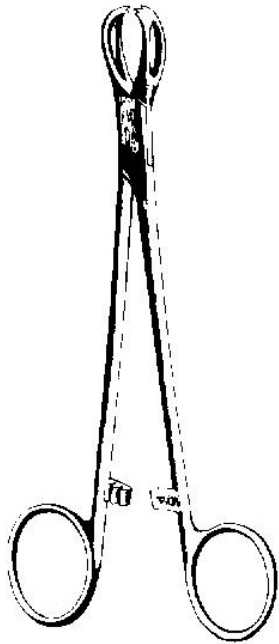

LANE
51-290 12.5cm
51-292 15 cm
51-294 19 cm

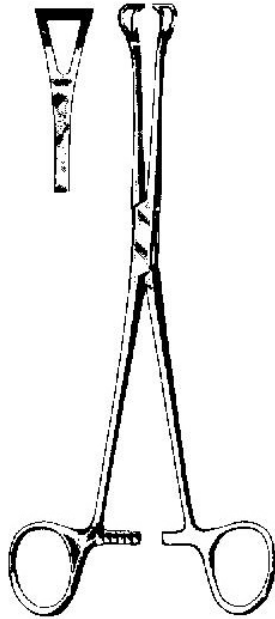

BOBCK
51-300 16cm
51-302 18cm
51-304 20cm
51-306 24cm

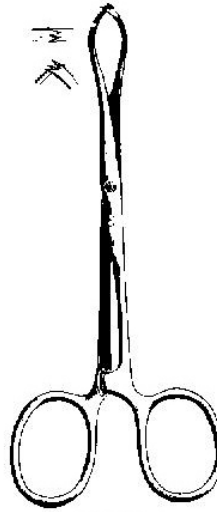

PORRIER
51-310 12.5cm
51-312 18 cm

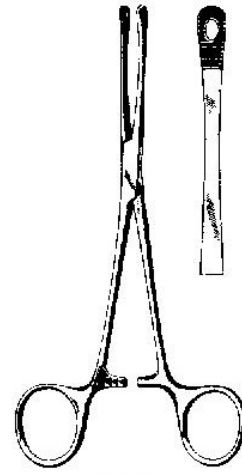

PERCY
51-320 24cm



DENNIS-BROWN
51-330 18cm



51-340

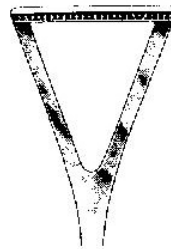

51-342

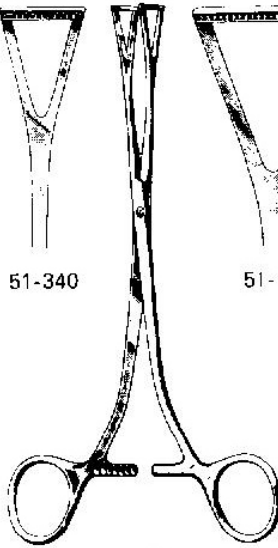

DUVAL-COLLIN
51-340 18cm
51-342 20cm



51-350



51-352

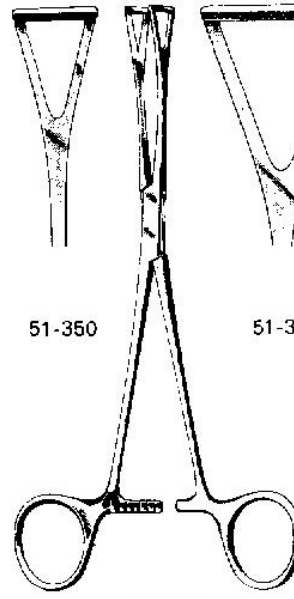

COLLIN
51-350 20cm
51-352 23cm



INTESTINES AND STOMACH
INTESTINAL FORCEPS

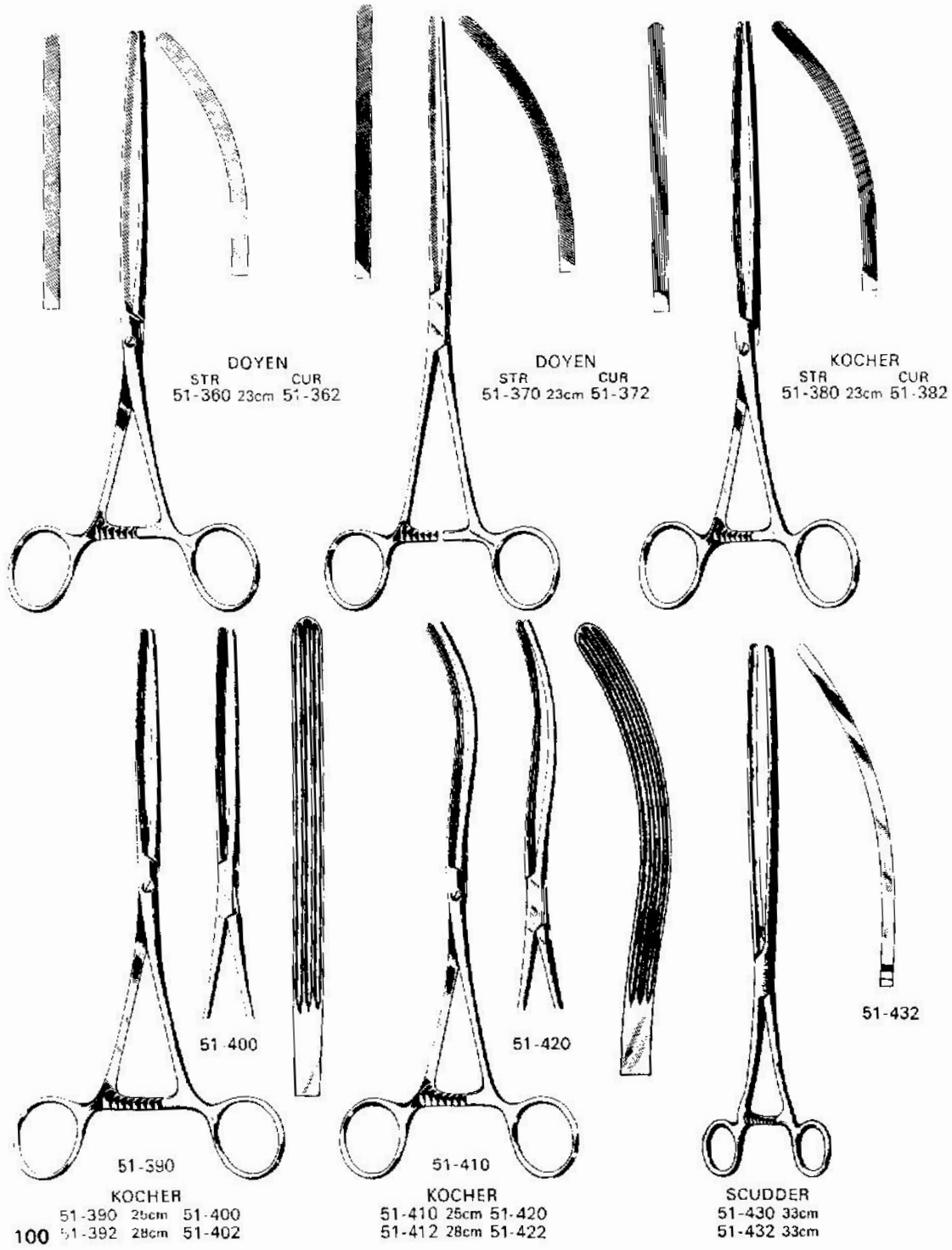

INTESTINES AND STOMACH
INTESTINAL FORCEPS

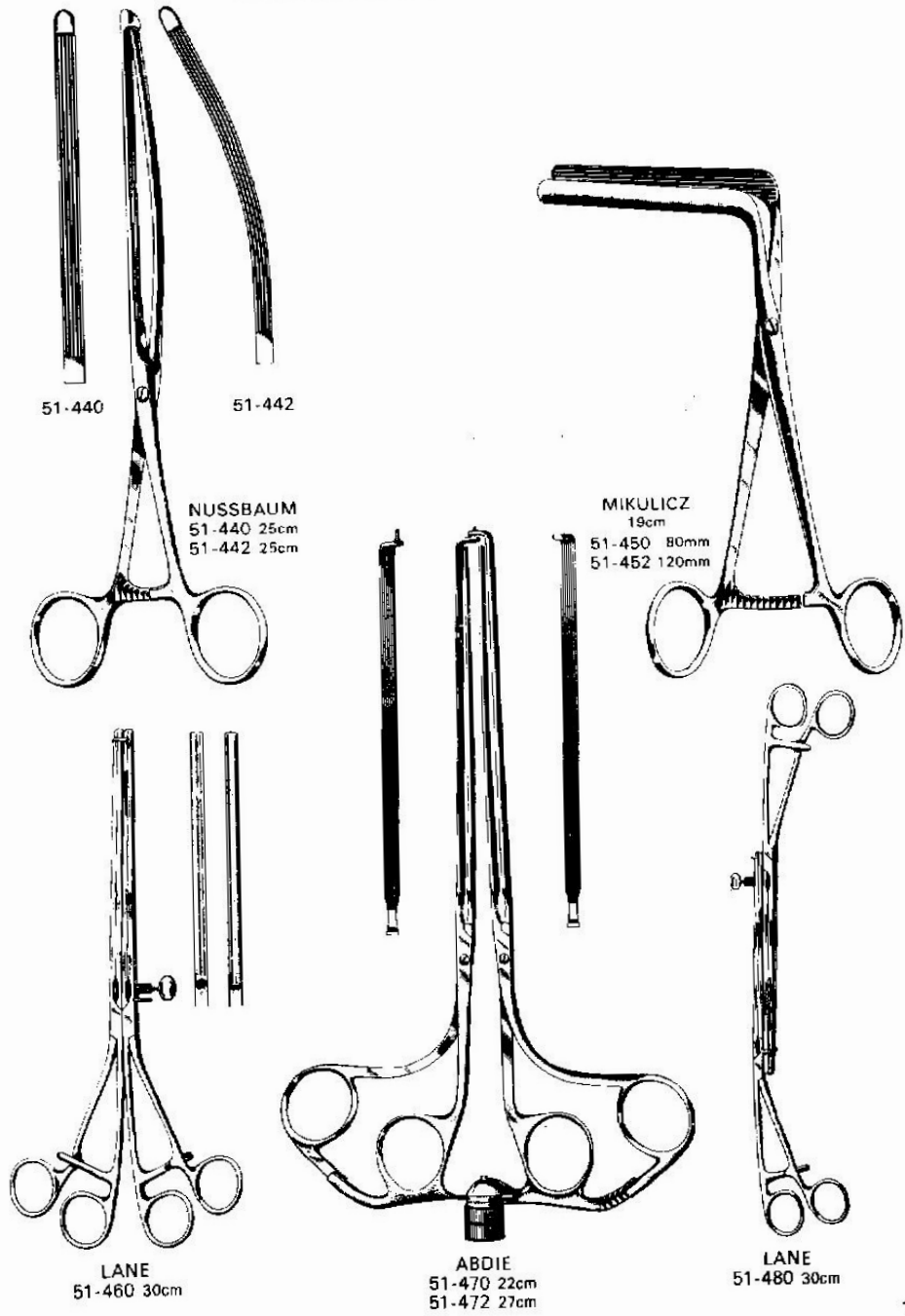

INTESTINES AND STOMACH
INTESTINAL AND STOMACH CLAMPS



LANE
51-490 30cm

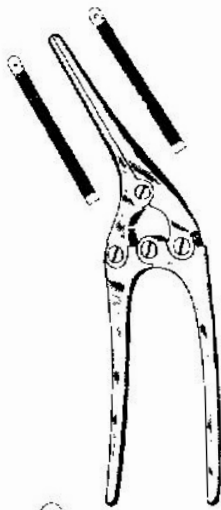

PAYR
51-500 15cm

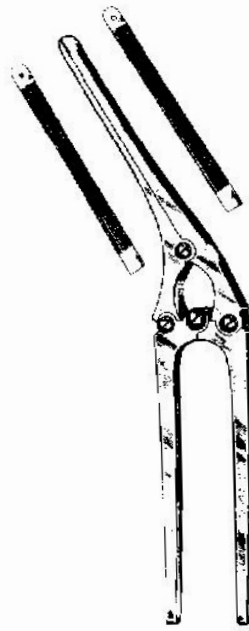

PAYR
51-510 21cm

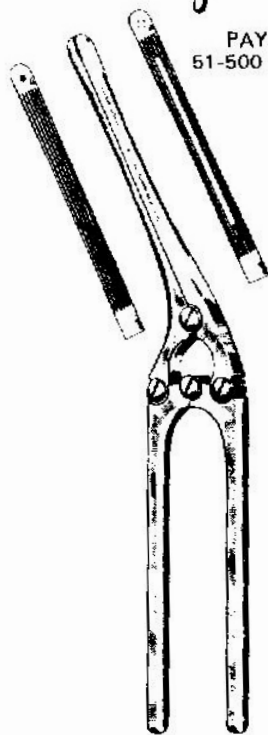

PAYR
51-520 29cm
51-522 35cm

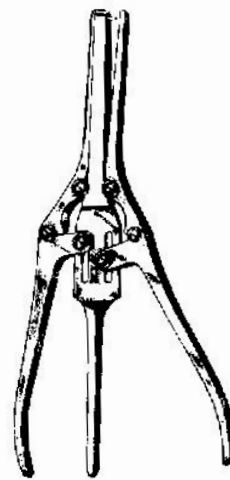

RANKIN
51-530 22cm

RECTUM
RECTAL SPECULA

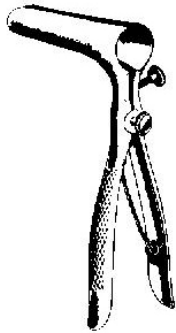

SIMS
53-100 15cm

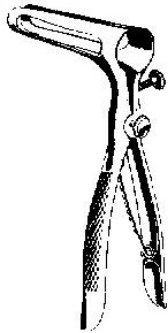

SIMS
53-110 15cm



SIMS
53-115 15cm

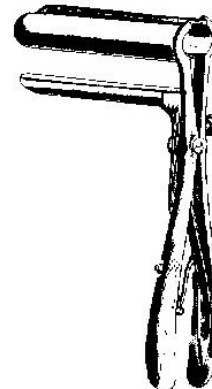

MATHIEU
53-120 19cm

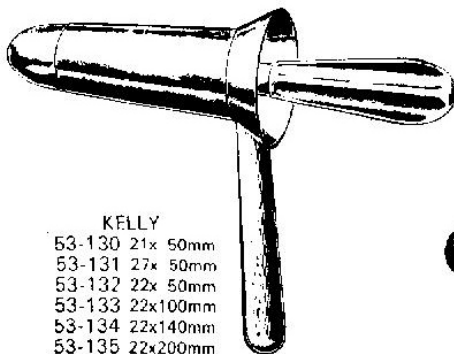

KELLY
53-130 21x 50mm
53-131 27x 50mm
53-132 22x 50mm
53-133 22x100mm
53-134 22x140mm
53-135 22x200mm

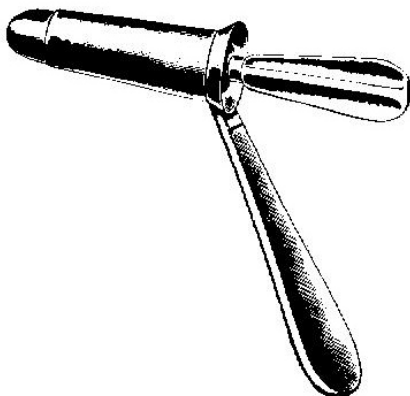

GABRIEL
53-140 64x24mm
53-142 49x19mm

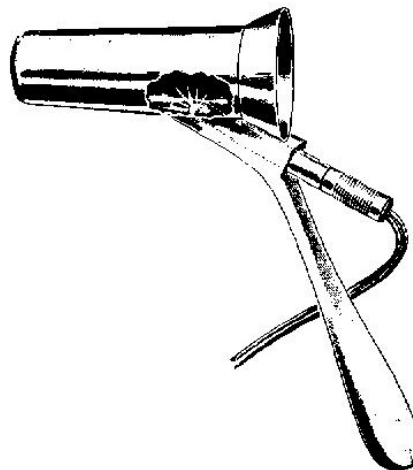

NAUTON-MORGAN
53-150 70x22mm

RECTUM

BIOPSY FORCEPS

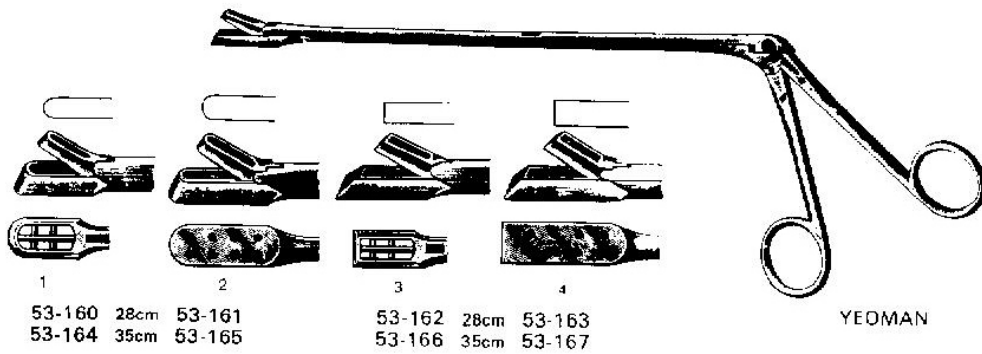

COTTON CARRIER

PILE FORCEPS

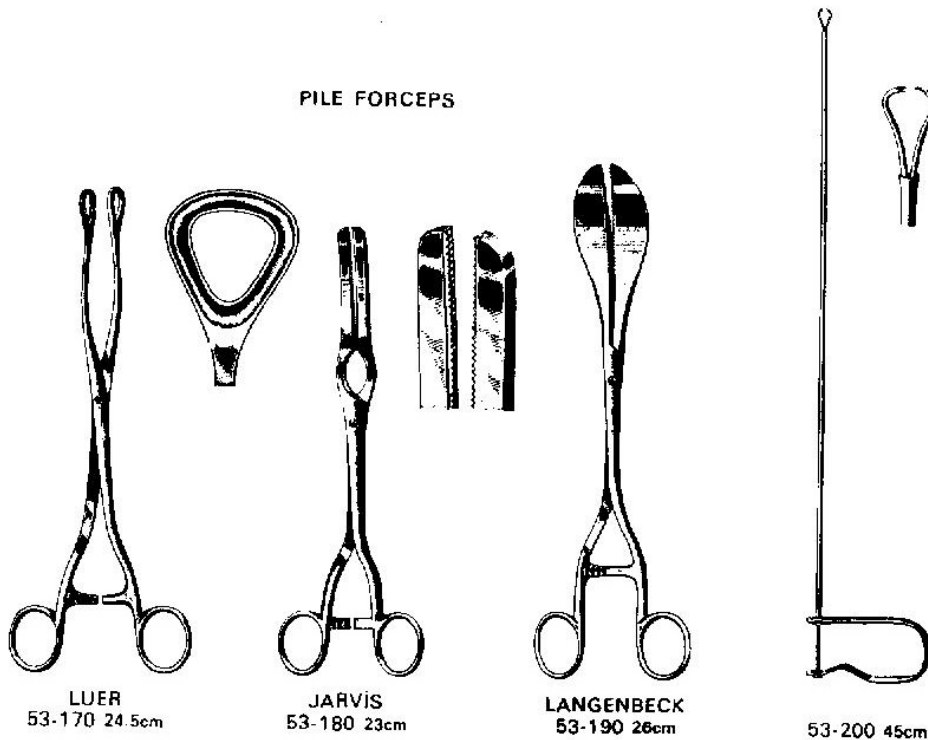

GALL BLADDER

DILATORS

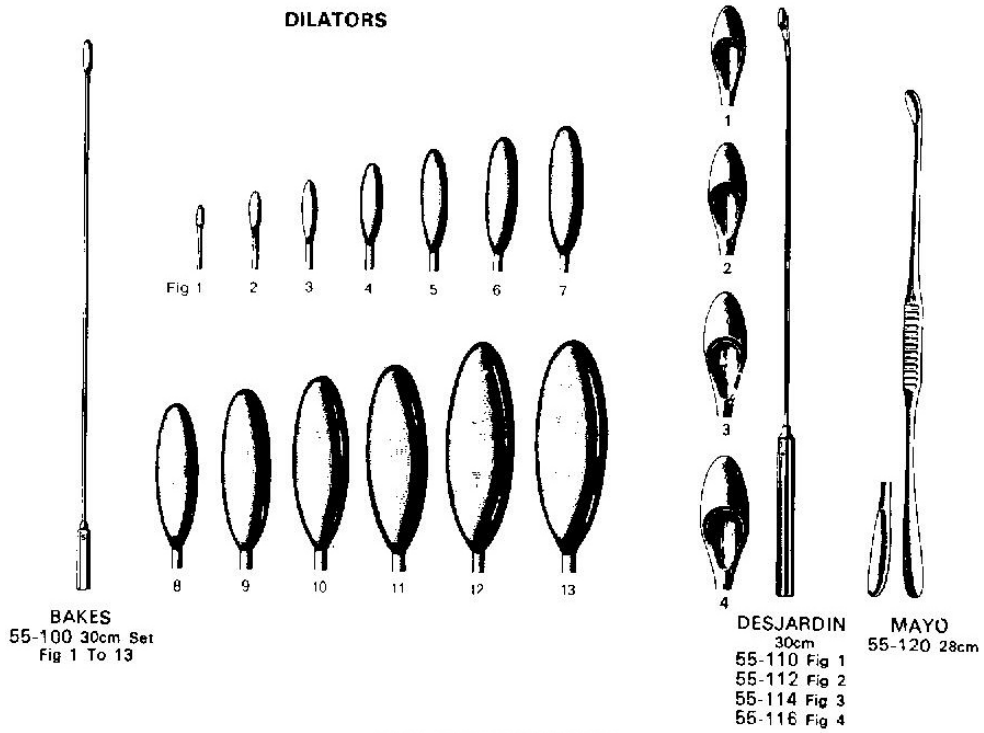

GALL STONE FORCEPS

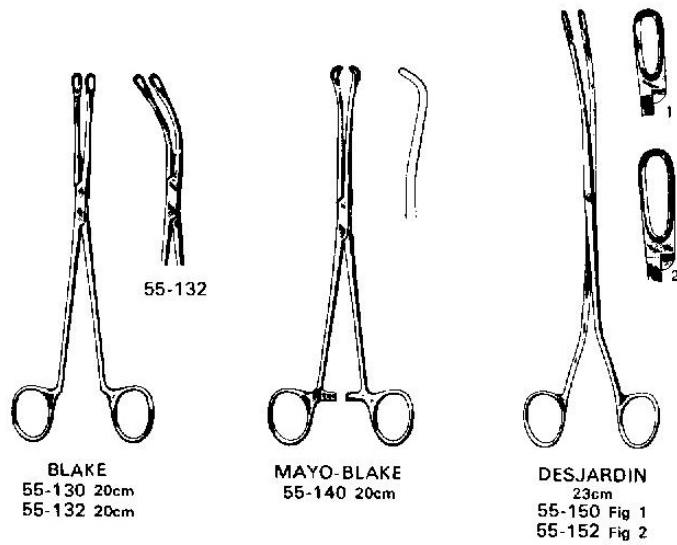

GALL BLADDER

KIDNEY FORCEPS

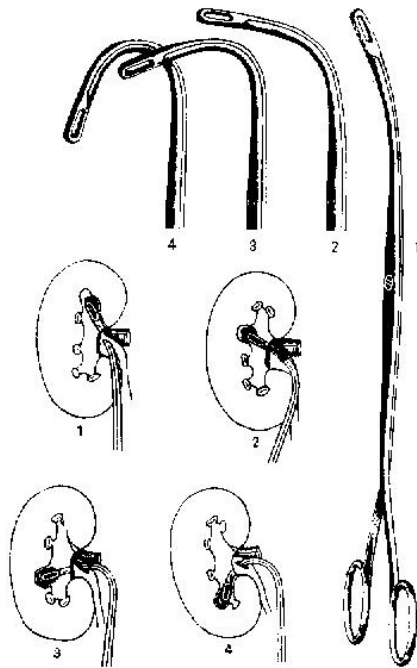

RANDALL
55-160 Fig 1 23cm
55-162 Fig 2 22cm
55-164 Fig 3 22cm
55-166 Fig 4 22cm

PROBE



MAYO
55-170 32cm

CATHETERS

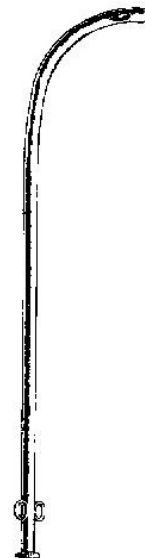

MERCIER
57-100 33cm
8 FG To 24 FG

**UROLOGY
CATHETERS**

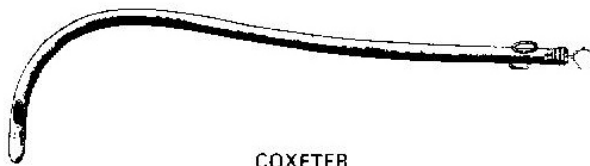

COXETER
57-110 28cm
8 FG To 24 FG



57-120 15cm
10 FG To 20 FG



57-130 20cm
8 FG To 24 FG

UROLOGY

URETHRAL BOUGIES

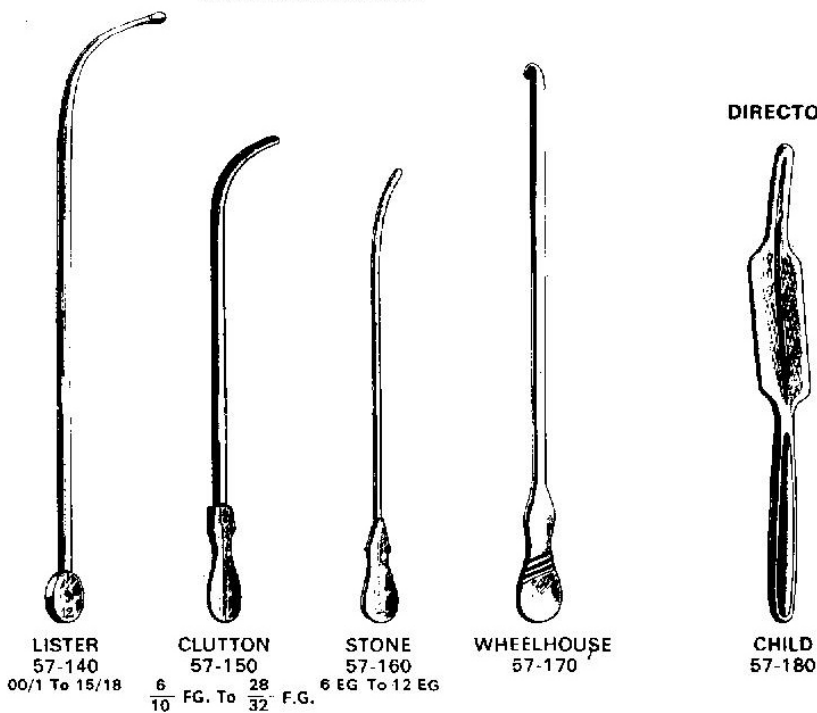

DIRECTORS



LISTER 57-140
00/1 To 15/18
CLUTTON 57-150
6/10 FG. To 28/32 F.G.
STONE 57-160
6 EG To 12 EG
WHEELHOUSE 57-170
CHILD 57-180

LITHOTOMY FORCEPS

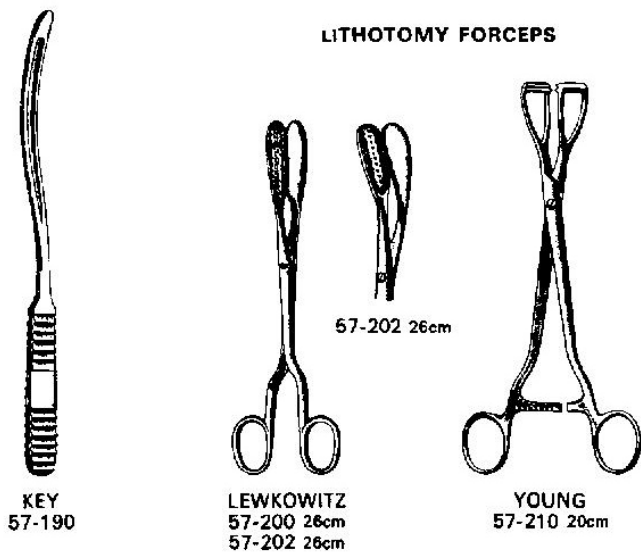

KEY 57-190
LEWKOWITZ 57-200 28cm
57-202 26cm
YOUNG 57-210 20cm

UROLOGY

RETRACTORS

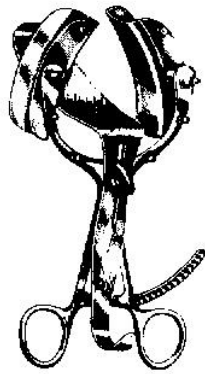

LEGUEU
57-220

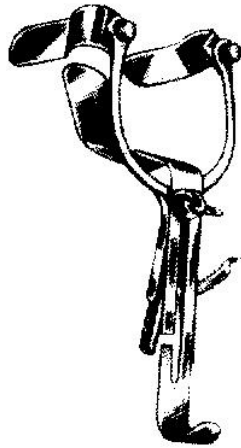

MILLIN
57-230

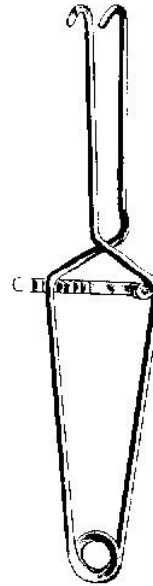

MILLIN
57-240

SUCTION TUBE

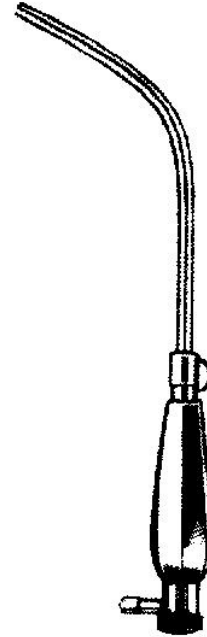

MILLIN
57-250

URETHRAL FOREIGN BODY FORCEPS

PROSTATECTOMY FORCEPS

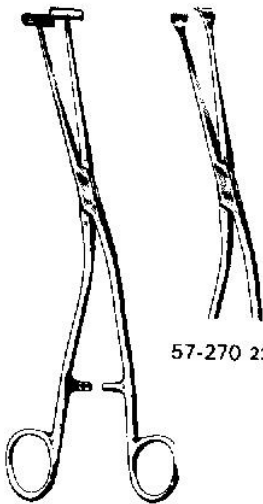

MILLIN
57-260 23cm

57-270 23cm

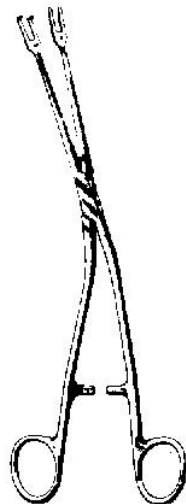

MILLIN
57-280 23cm

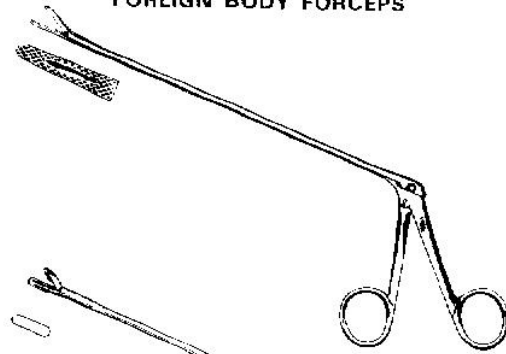

MATHIEU
57-290 20cm
57-292 28cm

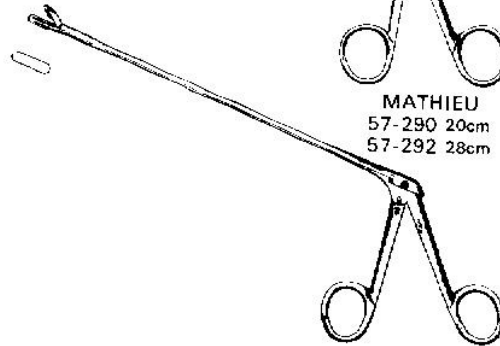

MATHIEU
57-300 20cm
57-302 28cm



GYNECOLOGY
VAGINAL SPECULA

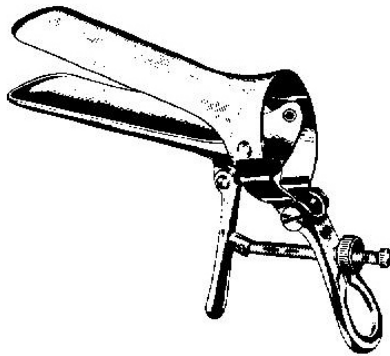

CUSCO
61-100 SMALL
61-102 MEDIUM
61-104 LARGE

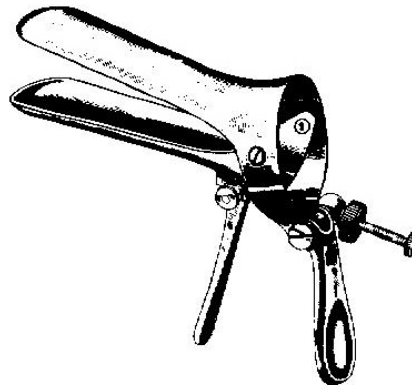

CUSCO
61-110 SMALL
61-112 MEDIUM
61-114 LARGE

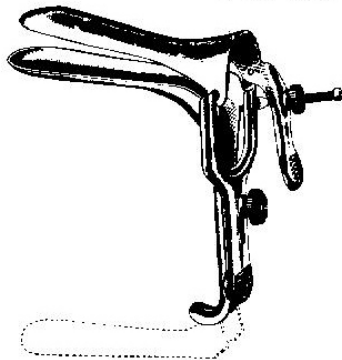

GRAVES
61-120 SMALL
61-122 MEDIUM
61-124 LARGE

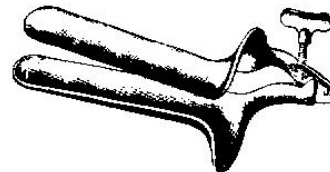

COLLIN
61-130 SMALL
61-132 MEDIUM
61-134 LARGE

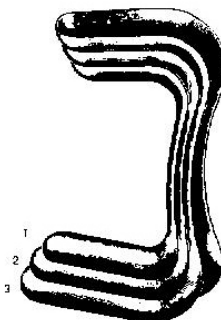

SIMS
61-140 SMALL
61-142 MEDIUM
61-144 LARGE

GYNECOLOGY
VAGINAL SPECULA

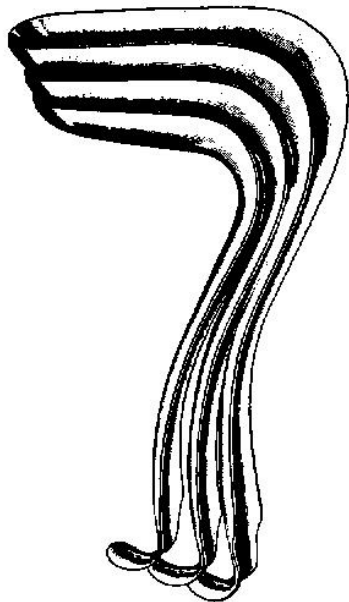

KRISTELLER
61-150 SMALL
61-152 MEDIUM
61-154 LARGE

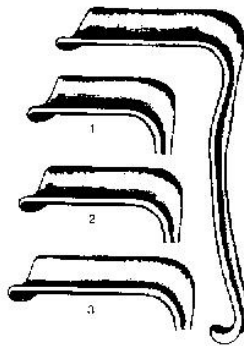

JACKSON
61-160 SMALL
61-162 MEDIUM
61-164 LARGE

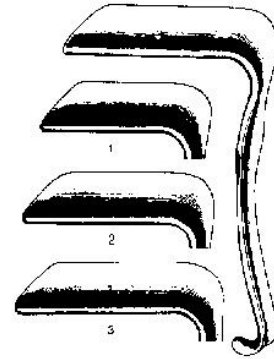

EASTMAN
61-170 SMALL
61-172 MEDIUM
61-174 LARGE

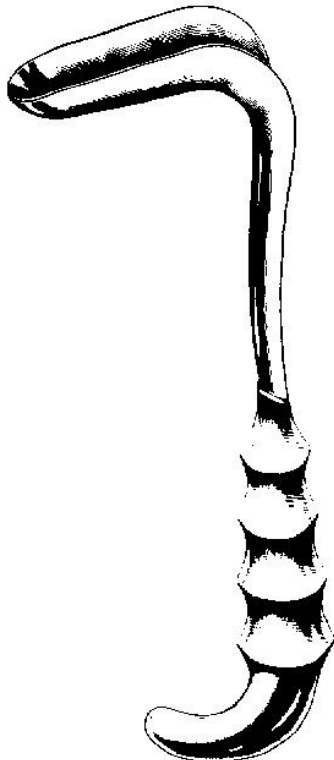

KALLMORGEN
61-180 90x40mm

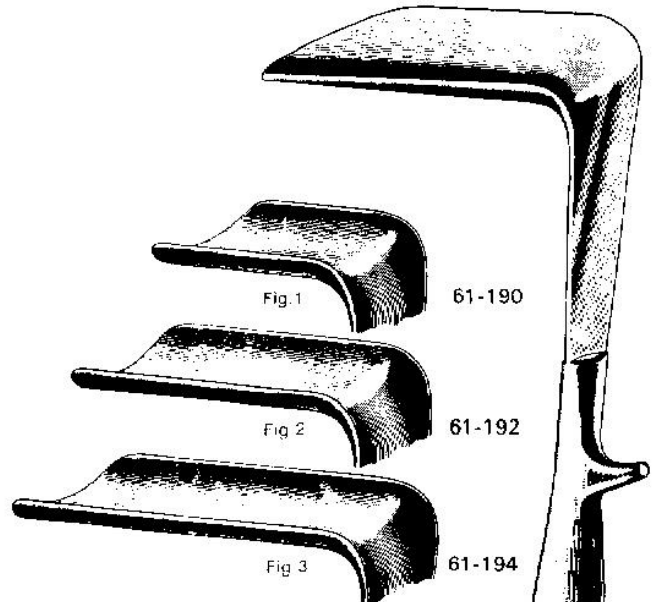

DOYEN
61-190 SMALL
61-192 MEDIUM
61-194 LARGE

GYNECOLOGY
VAGINAL SPECULA

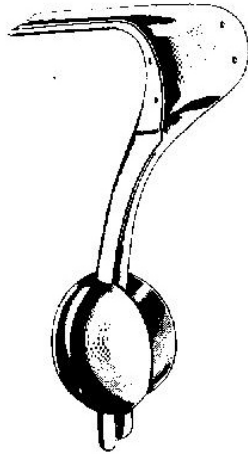

AUVARD
61-200 2½ Lbs
61-202 3 Lbs

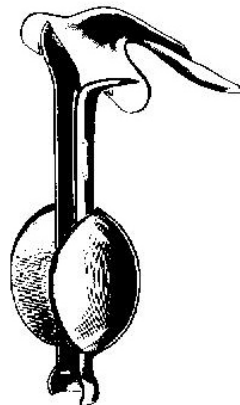

AUVARD
61-210 3 Lbs



AUVAND
61-220 2½ Lbs
61-222 3 Lbs



65 x 30mm
75 x 35mm
85 x 35mm
95 x 35mm

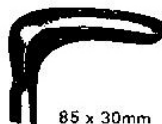

85 x 30mm
85 x 33mm
100 x 38mm
110 x 42mm



BOZEMANN
61-230



BOZEMANN
61-240



BREISKY
61-250 100x20mm
61-251 100x25mm
61-252 100x30mm
61-253 100x35mm
61-254 100x40mm



LANDAU
61-260 100x28mm
61-262 100x38mm

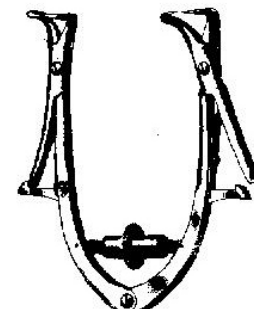

FREDMANN
61-270 10cm



GYNECOLOGY
UTERINE DILATORS

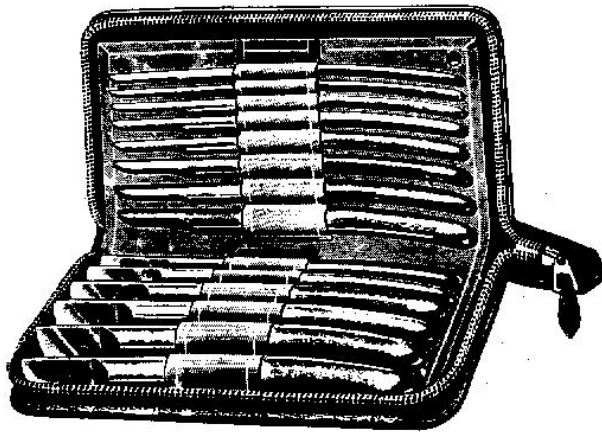

HEGAR
61-280 SET OF 14
4mm To 17mm

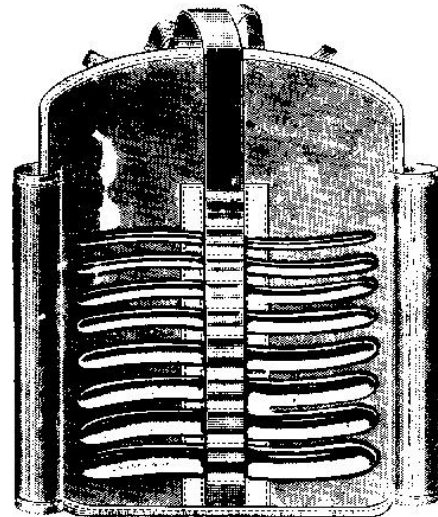

HEGAR
61-290 SET OF 8
3/4 To 17/18



HANK
51-300 SET OF 6
9/10 TO 19/20



HAWKINS-AMBER
61-310 SET OF 16
3-6 To 18-21



JOLLY
61-320 SET OF 5
3-7 To 12-18

GYNECOLOGY
UTERINE DILATORS

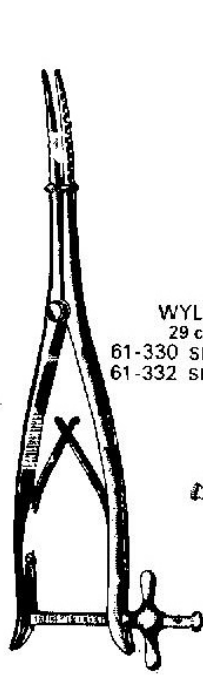

WYLIE
29 cm
61-330 SERATED
61-332 SMOOTH

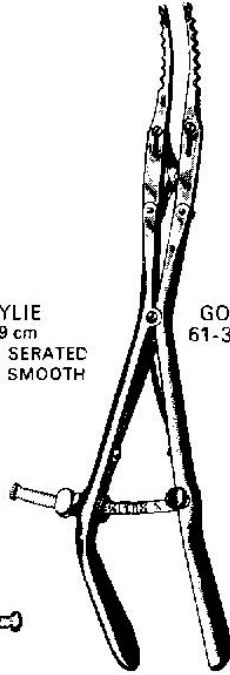

GOODELL
61-340 34cm

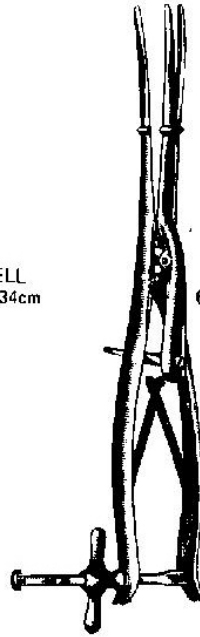

SIMS
61-350 29cm

DEPRESSORS



BRAUN
61-360 28cm

UTERINE SOUNDS

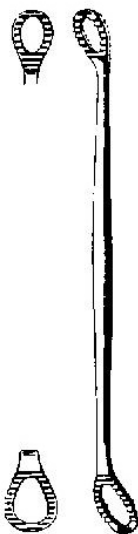

SIMS
61-380 26cm



SIMS
61-390 32cm

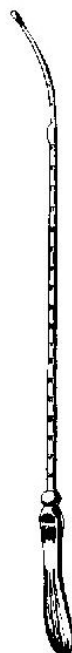

MARTIN
61-400 32cm



GALABIN
61-410 32cm



HORROCKS
61-420 32cm



SIMPSON
61-430 32cm



GYNECOLOGY
TENACULUM FORCEPS



SCHROEDER
61-440 25cm

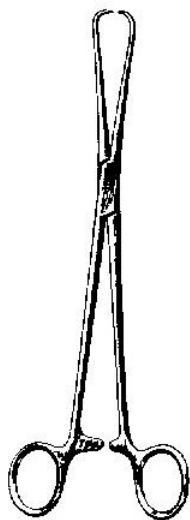

SCHROEDER
61-450 25cm

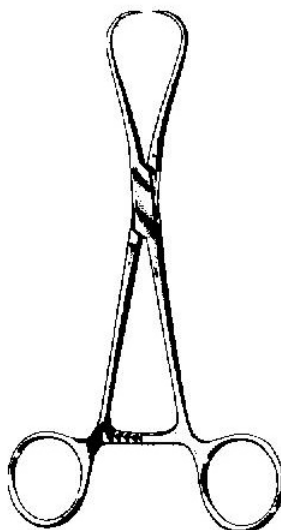

STAUDE-MODRE
61-460 17cm

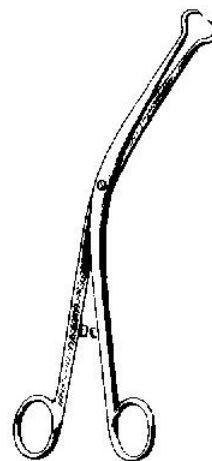

SKENE
61-470 23cm

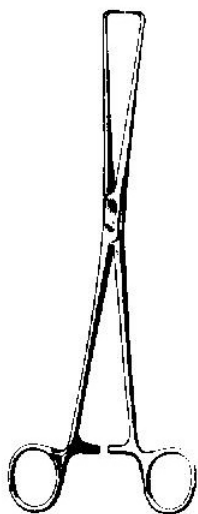

BRAUN
61-480 25cm

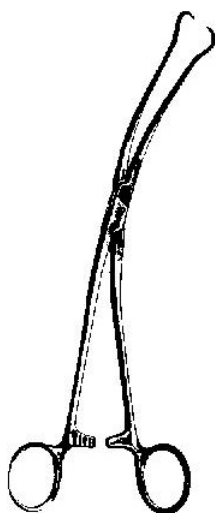

SKENE
61-490 24cm

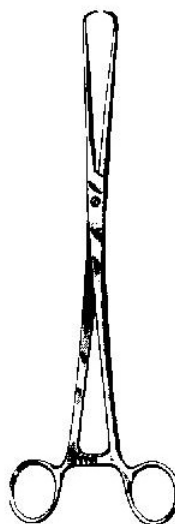

POZZI
61-500 25cm

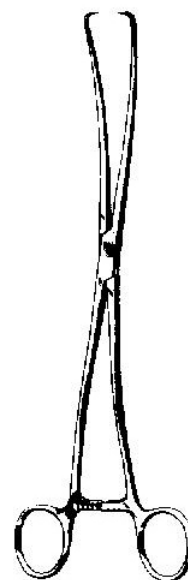

DUPLAY
61-510 28cm



GYNECOLOGY
VULLSELLUM FORCEPS

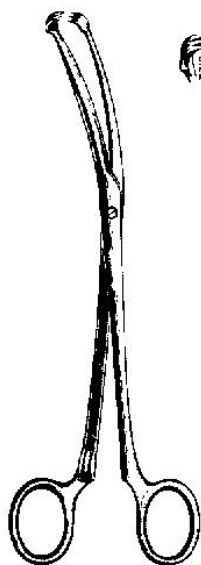

TEALE
61-520 18cm
61-522 23cm

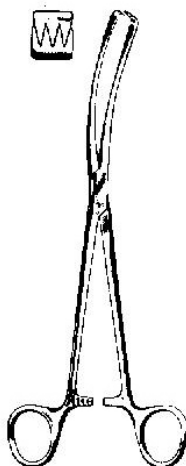

TEALE
61-530 23cm

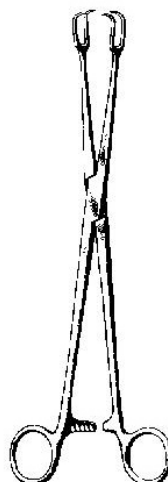

SCHROEDER
61-540 24cm
61-542 24cm
61-544 24cm



61-542



61-544



SKENE
61-550 26cm



MUSEUX
24 cm

STR	CUR
61-560 6mm	61-570
61-562 8mm	61-572
61-564 10mm	61-574



6 mm



8 mm

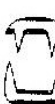

10 mm

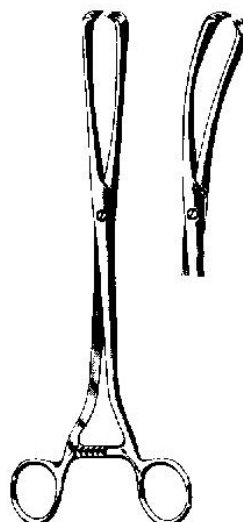

MUSEUX
24 cm

STR	CUR
61-580 9mm	61-590
61-582 11mm	61-592
61-584 13mm	61-594



9 mm



11 mm



13 mm

GYNECOLOGY

VULSELLUM FORCEPS

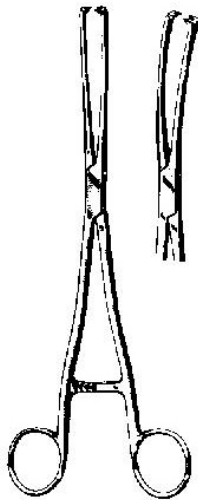

MUSEUX
STR 24 cm CUR
61-600 6mm 61-610
61-602 8mm 61-612
61-604 10mm 61-614



MUSEUX
61-620 20.5cm

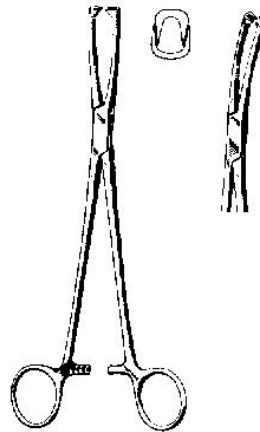

JACOBS
61-630 21cm
61-632 21cm

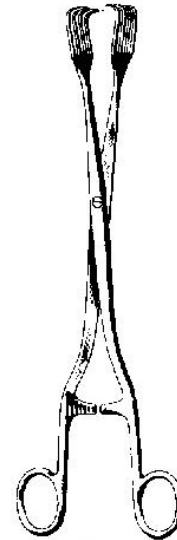

PRATT
61-640 28cm

HYSTERECTOMY FORCEPS

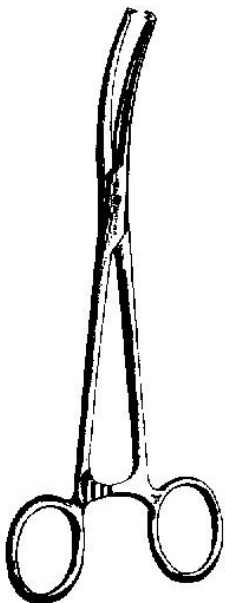

MAINGOT
61-650 20cm
61-652 24cm

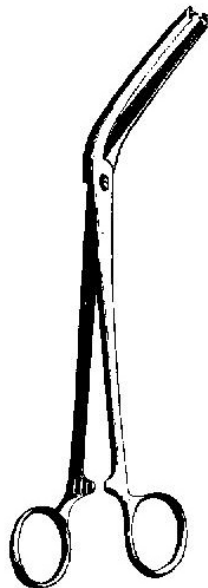

BERKLEY BONNEY
61-660 19cm

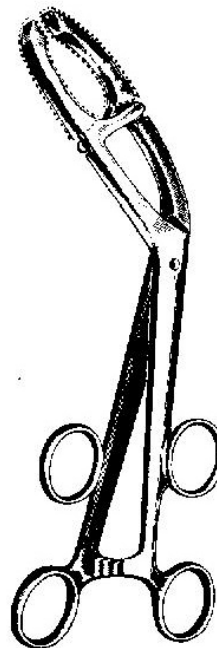

BONNEY
61-670 27cm

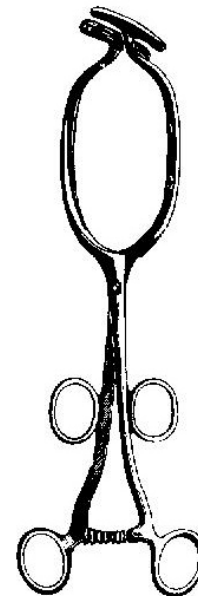

BONNEY
61-680 35cm

GYNECOLOGY

POLYPUS FORCEPS

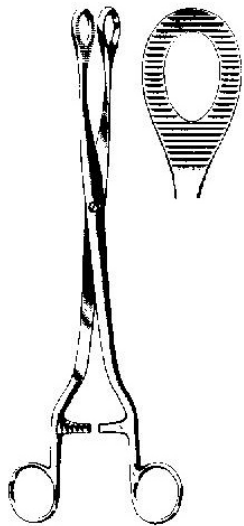

NOTO
61-690 27cm

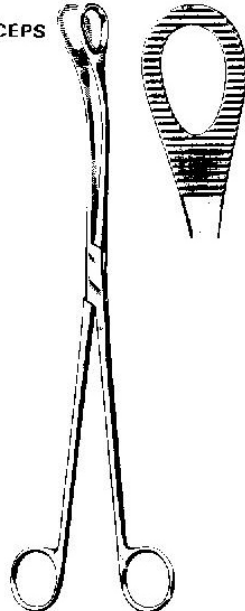

KELLY
61-700 32cm

ELEVATING FORCEPS



DARTIGUES
61-710 27cm

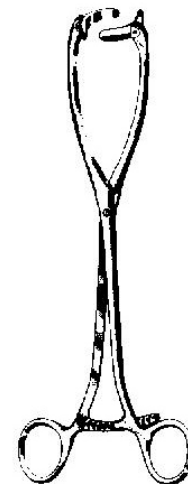

COLLIN
61-720 25cm

BIOPSY

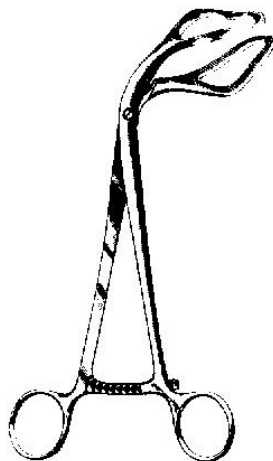

SOMER
61-730 23cm

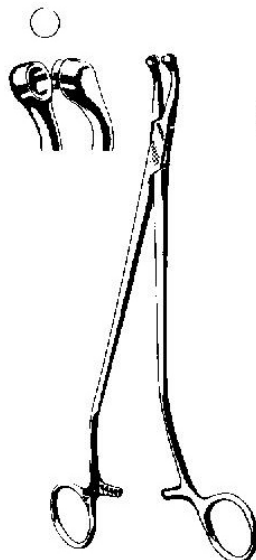

THOMAS-GAYLOR
61-740 22cm
61-742 24cm

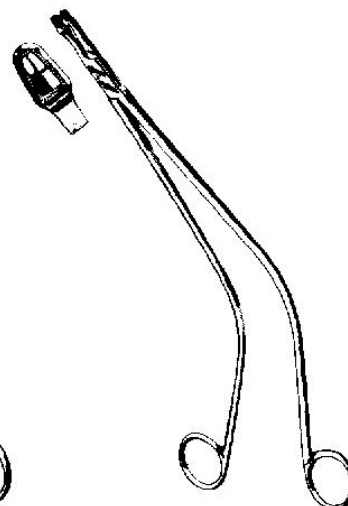

SCHUBERT
61-750 26cm

GYNECOLOGY
UTERINE BIOPSY FORCEPS

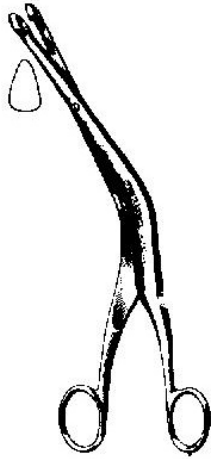

FAURE
61-760 24cm

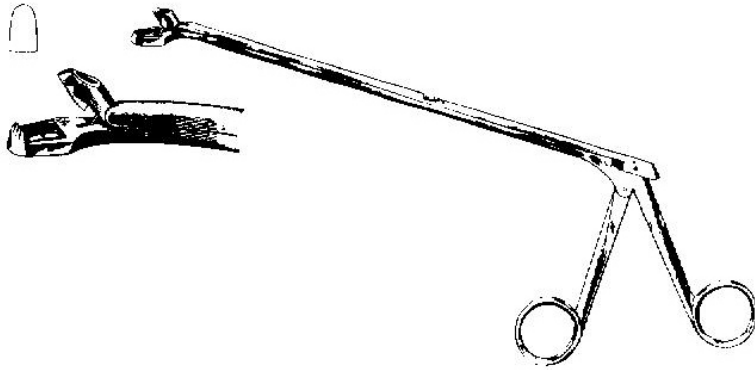

WITTNER
61-770 23cm



VAN-DOREN
61-780

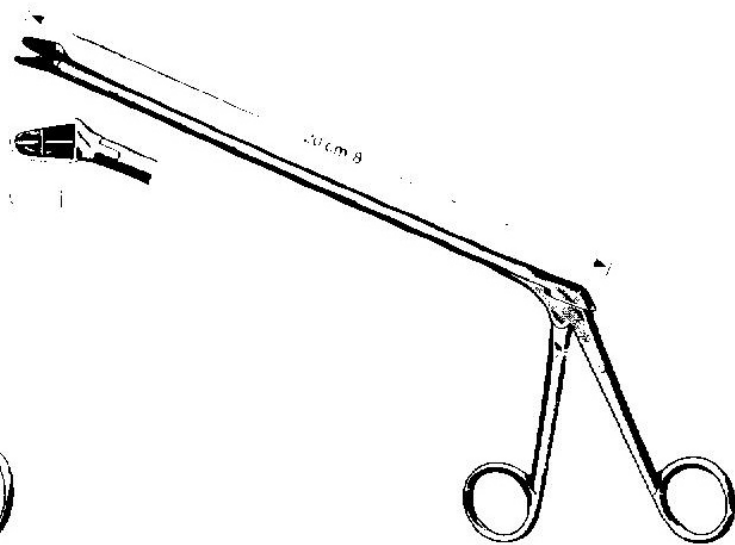

ALEXANDER
61-790 28cm

113

GYNECOLOGY
UTERINE CURETTES

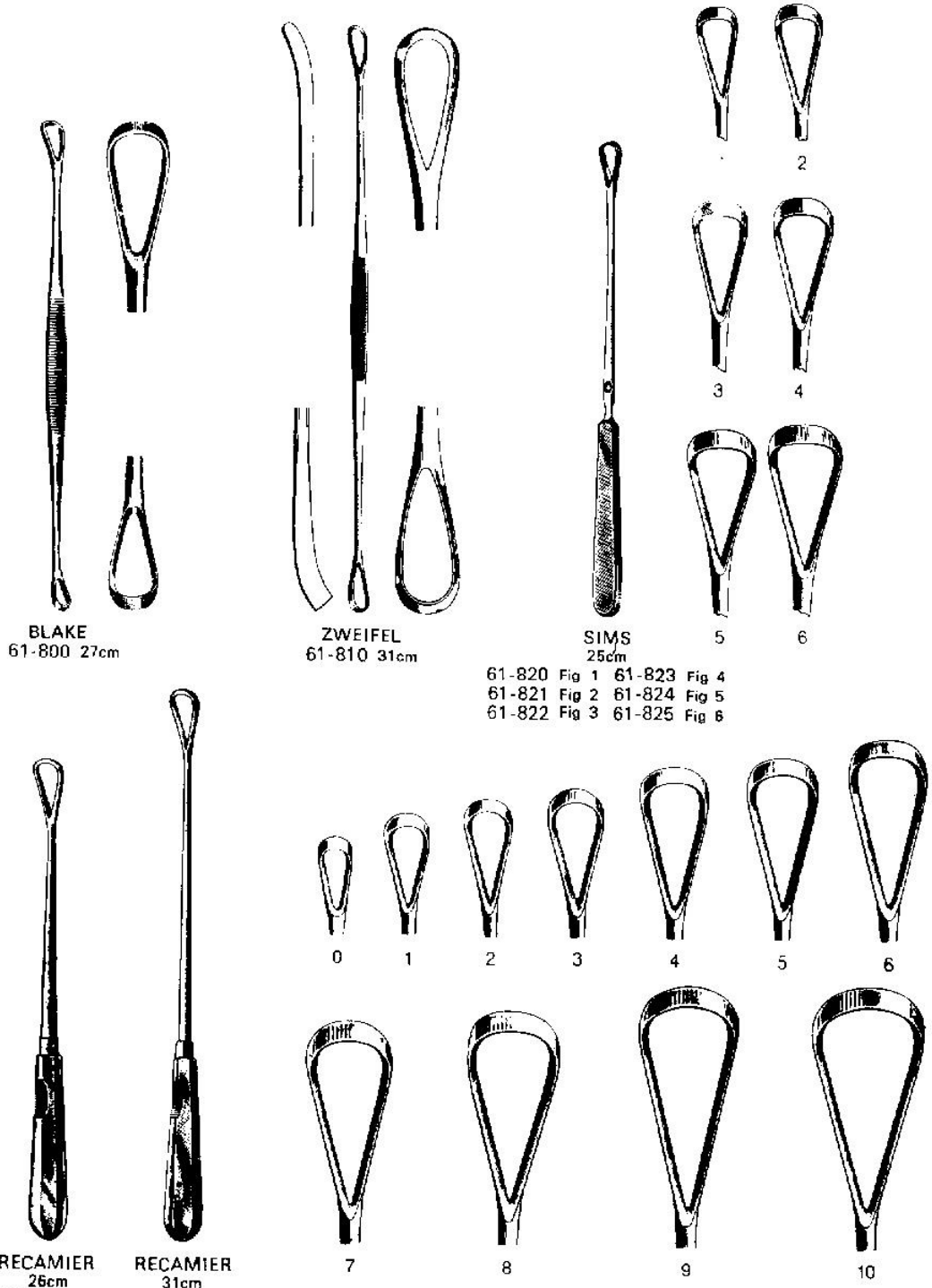

BLAKE
61-800 27cm

ZWEIFEL
61-810 31cm

SIMS
25cm

61-820 Fig 1 61-823 Fig 4
61-821 Fig 2 61-824 Fig 5
61-822 Fig 3 61-825 Fig 6

RECAMIER 26cm
61-830 SHARP Fig 1 to 10 61-850
RECAMIER 31cm
61-840 BLUNT Fig 1 to 10 61-860



GYNECOLOGY
UTERINE CURETTES



SIMS
25cm

61-870 SHARP Fig 1 to 6
61-880 BLUNT Fig 1 to 6



1



2



3



4



5



6



THOMAS
28cm

61-890 SHARP Fig 1 to 6
61-900 BLUNT Fig 1 to 6



1



2



3



4



5



6



REINSTATER

120

61-910 29cm SHARP
61-920 29cm BLUNT



CHELSEA

61-930 31cm



RANDALL

61-940 24cm



NOVAK

61-950 23cm



SHARMAN

61-960 23cm

MYOMA SCREW



DOYEN

61-970

OBSTETRICS
OBSTETRICAL FORCEPS

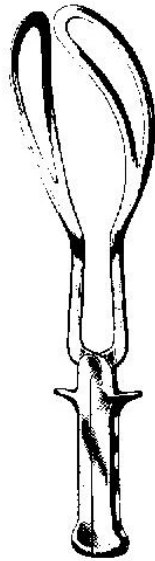

DE-LEE
63-100 39cm

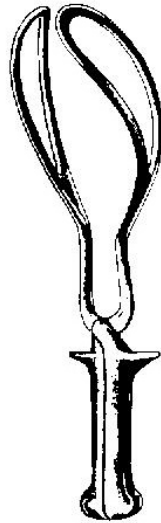

DE-LEE
63-110 36cm

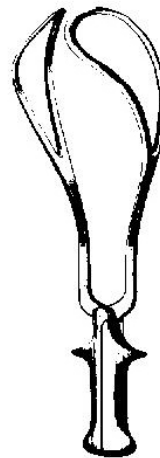

DE-LEE
63-120 30cm



SIMPSON
63-130 30cm

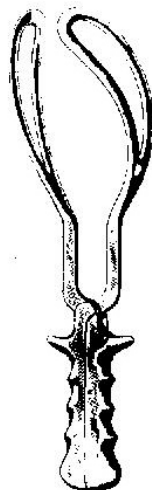

SIMPSON-BRAUN
63-140 33cm
63-142 36cm



WRIGLEY
63-150 27cm

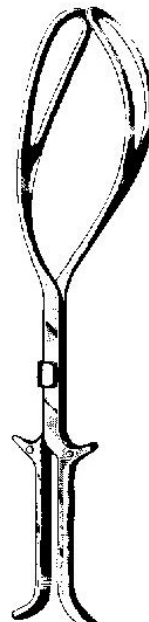

KILLAND
63-160 41cm

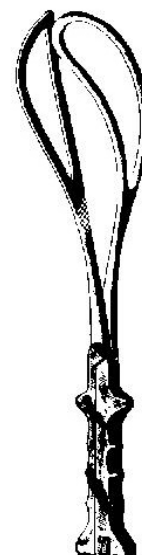

ELLIOT
63-170 32cm
63-172 38cm



OBSTETRICS
OBSTETRICAL FORCEPS

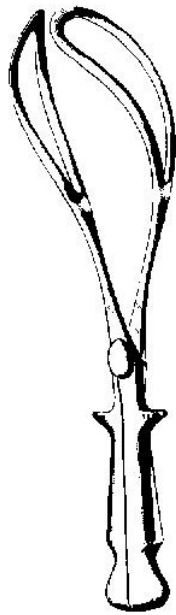

NAEGELE
63-180 36cm
63-182 40cm



KEDARNATH DAS
63-190 33cm

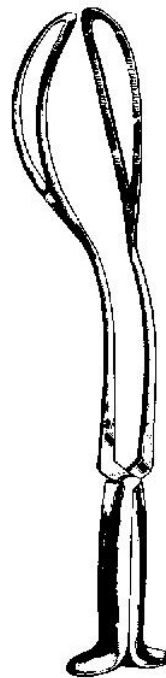

PIPER
63-200 44cm



BOERMA
63-210 29cm

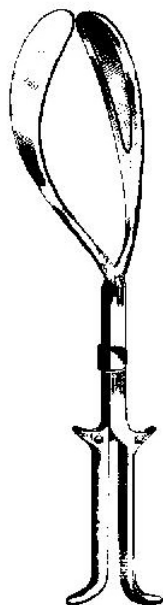

KIELAND-LUIKART
63-220 40cm

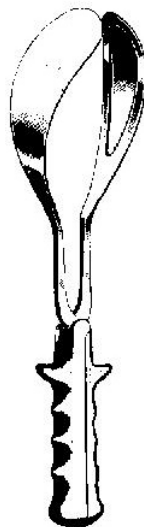

SIMPSON-LUIKART
63-230 36cm

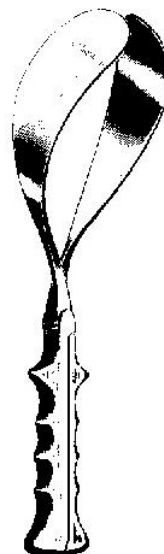

McLEAN
63-240 36cm

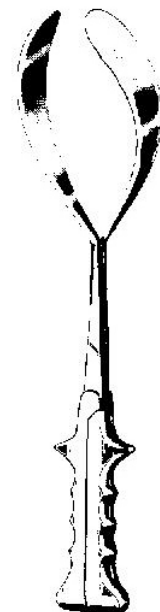

McLEAN-TUCKER
63-250 39cm



OBSTETRICS
OBSTETRICAL FORCEPS

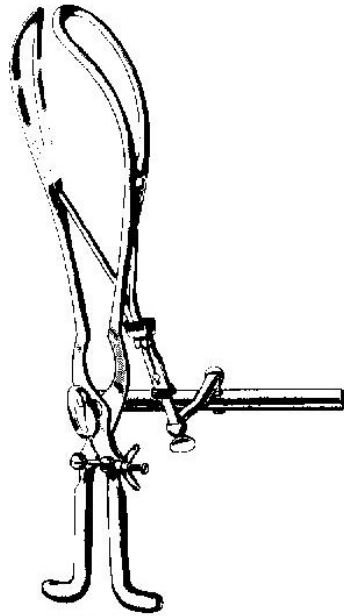

TARNIER
63-260 38cm
63-262 40cm
63-264 42cm

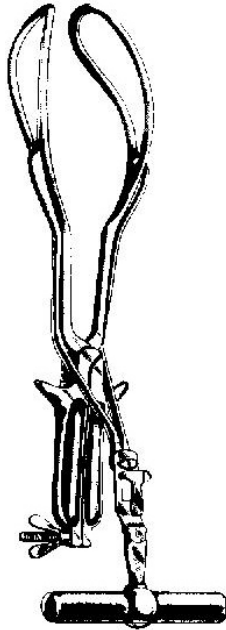

KEDARNATH DAS
63-270 38cm

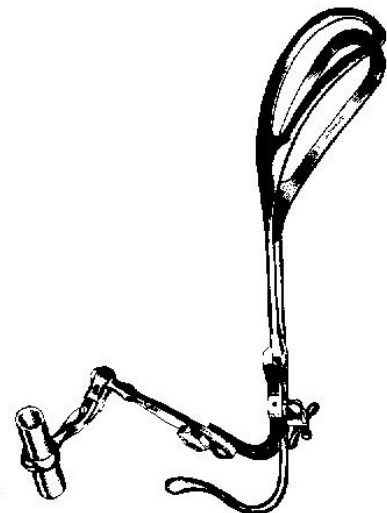

DEWEY
63-280 37cm

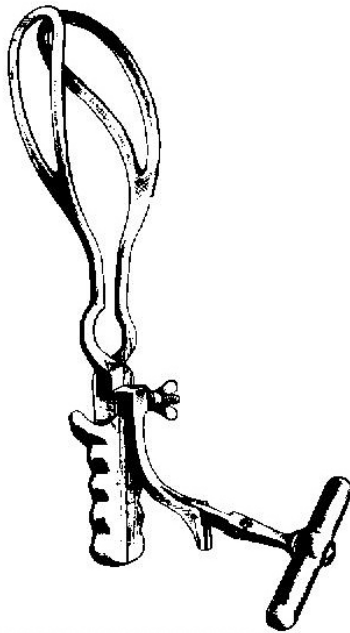

BARNES-NEVILLE-SIMPSON
63-290

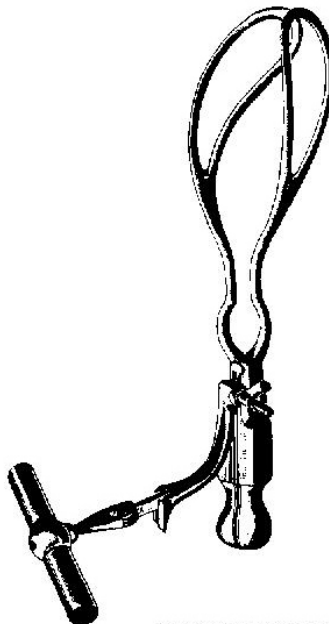

BARNES-NEVILLE
63-300

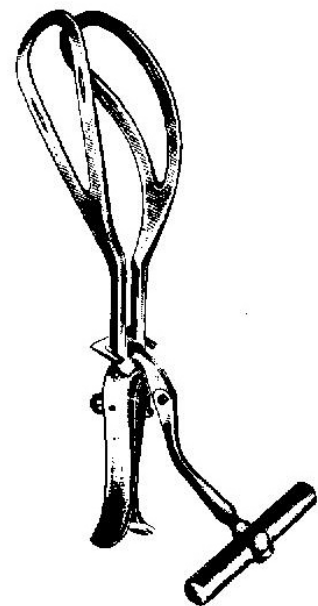

HAIG-FERGUSON
63-310



SURGICAL INSTRUMENTS

**OBSTETRICS
CRANIOCLAST**

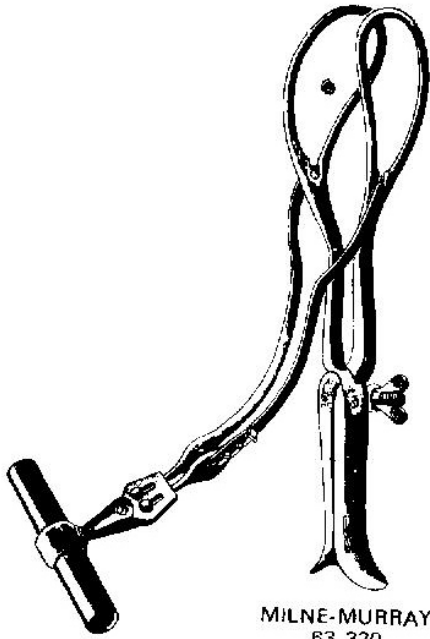

MILNE-MURRAY
63-320

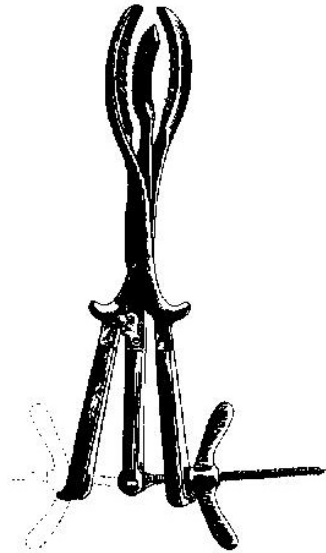

WINTER
63-330

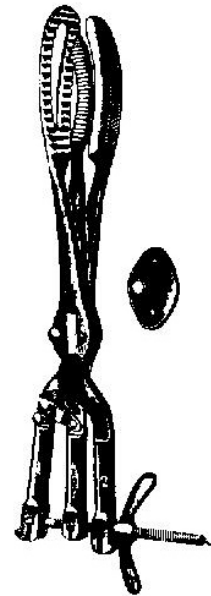

AUVARD-ZWEIFEL
63-340 46cm

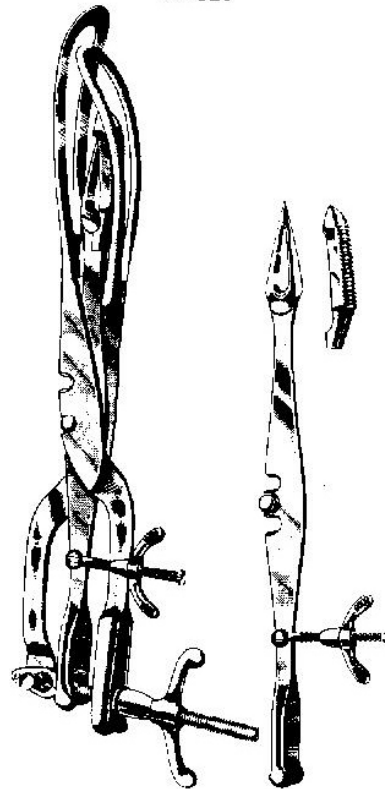

TARNIER
63-350 46cm

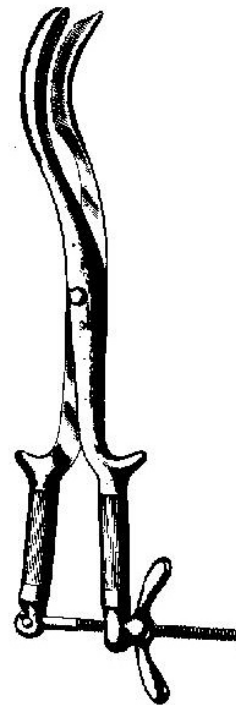

BRAUN
63-360 42cm

OBSTETRICS

PERFORATORS

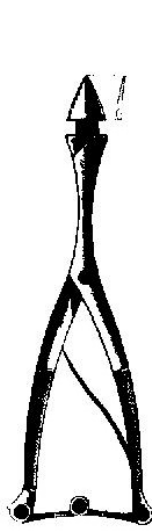

SIMPSON
63-370 30cm

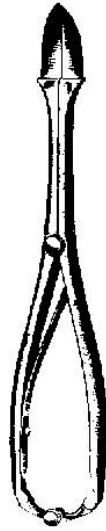

NAEGELE
63-380 25cm

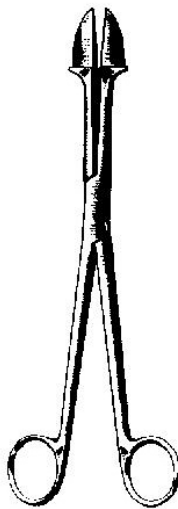

SMILLIE
63-390 25cm

HOOKS



SMELLIE
63-400 33cm



BRAUN
63-410 30cm

HOOKS



63-420 26cm



TARGETT
63-430 30cm

PELVIMETERS

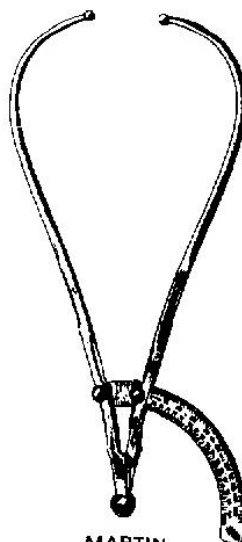

MARTIN
63-440 33cm



COLLIN
63-450 35cm

OBSTETRICS

PELVIMETERS

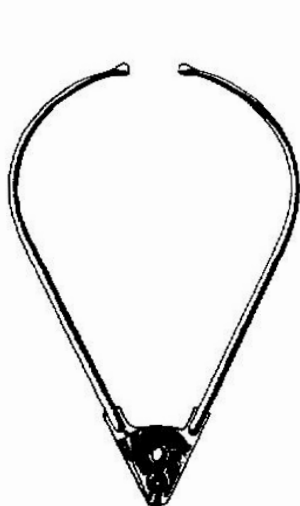

COLLYER
63-460 30cm

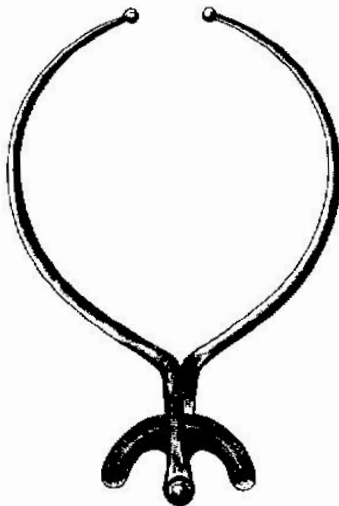

BREISKY
63-470 33cm

UMBILICAL CLAMP

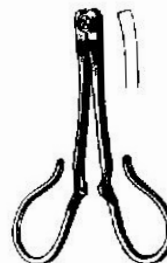

KANE
63-480 8.5cm

PLACENTA FORCEPS

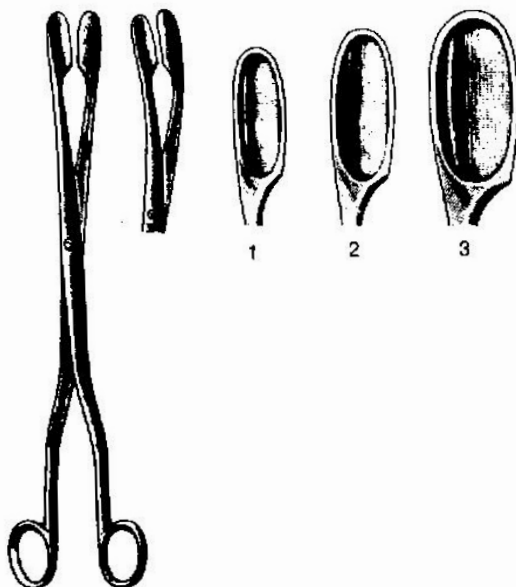

WINTER
STR 28cm CUR
63-490 Fig 1 63-500
63-492 Fig 2 63-502
63-494 Fig 3 63-504

OVUM FORCEPS

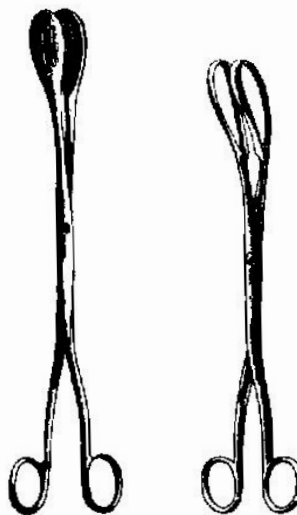

HEYWOOD-SMITH 63-510 26.6cm
COREY 63-520 24cm

OBSTETRICS

PLACENTA AND HAEMOSTATIC FORCEPS



SAENGER
63-530 27cm
63-532 27cm

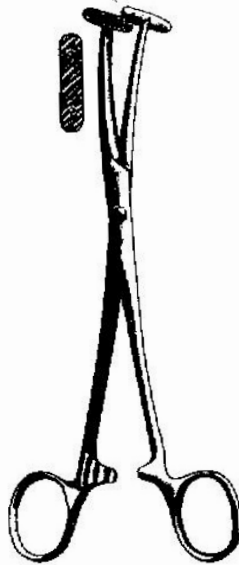

WILLET
63-540 19cm

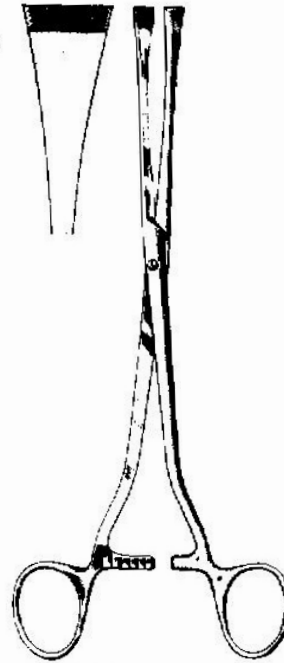

GREEN-ARMYTAGE
63-550 21cm

CATHETERS AND TUBES



CARTON
63-560 30cm



BOZEMANN-FRITSCH
63-570 8mm \varnothing
63-572 10mm \varnothing
63-574 12mm \varnothing



DREW SYMTH
63-580



PROVIS
63-590



SPACKMANN
63-600 18cm

**STERILIZATION
STERILIZING FORCEPS**

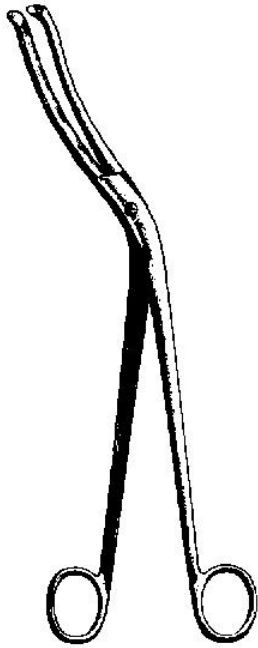

CHEATLE
65-100 27cm

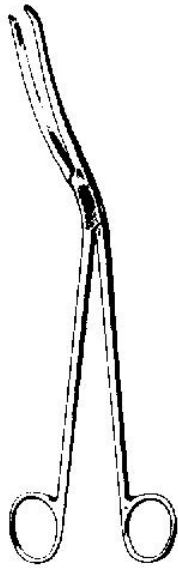

CHEATLE
65-110 27cm

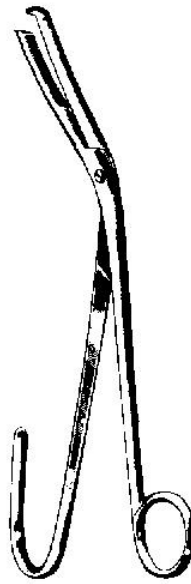

CHEATLE
65-120 28cm

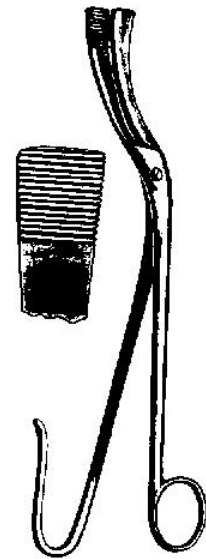

LONDON PATT
65-130 28cm



HARRISON
65-140 25cm
65-142 30cm
65-144 36cm
65-146 46cm

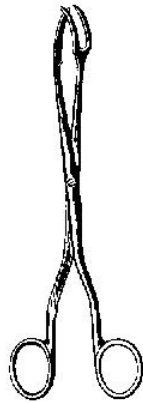

65-150 20cm
65-152 30cm



DAVIS
65-160 16cm
65-162 20cm
65-164 24cm

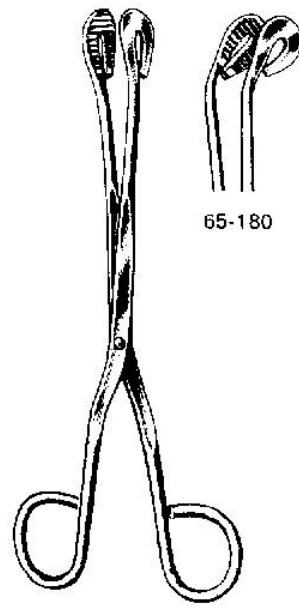

UTILITY
65-170 20cm 65-180
65-172 28cm 65-182

ORTHOPAEDIC
BONE SCREW AND PLATE HOLDING FORCEPS

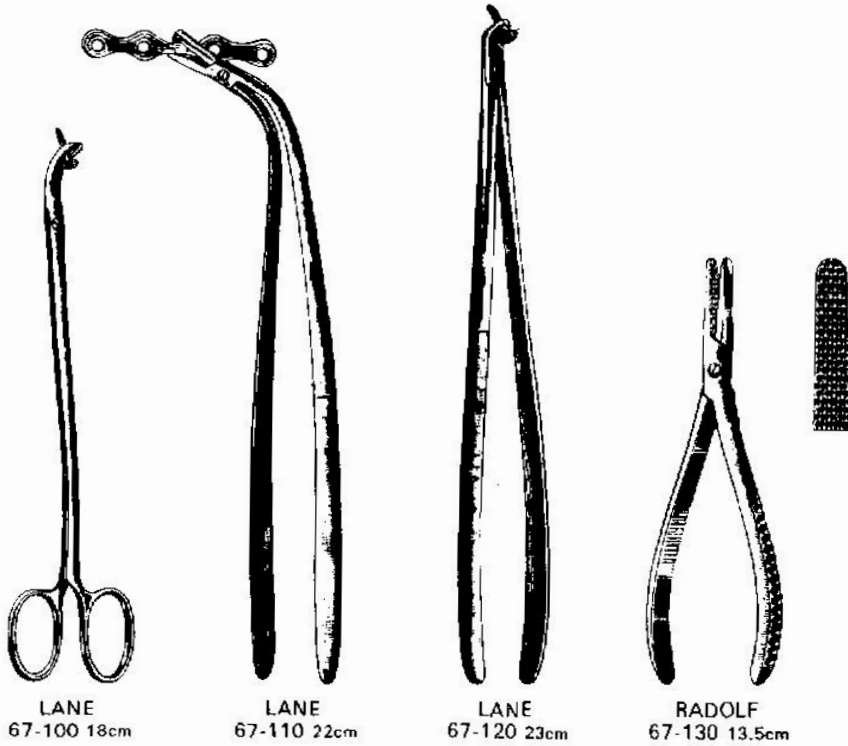

LANE
67-100 18cm

LANE
67-110 22cm

LANE
67-120 23cm

RADOLF
67-130 13.5cm

DERMATOLOGY

CUTICLE



STR	CUR
69-100 9cm	69-110
69-102 10cm	69-112
69-104 11cm	69-114

NAIL

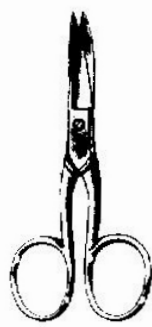

STR	CUR
69-120 10cm	69-130

NAIL CUTTERS

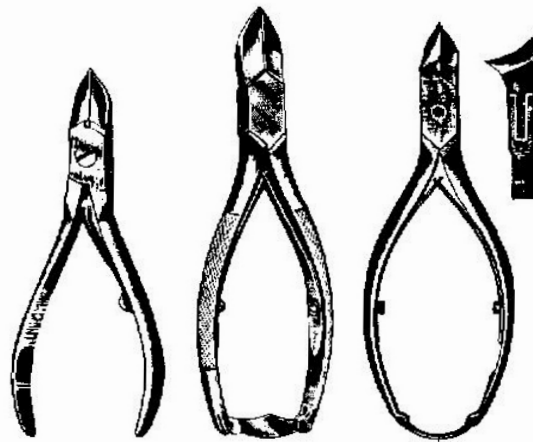

69-140 12cm

69-150 14cm
69-152 16cm

69-160 14cm



STERILIZING DRUMS

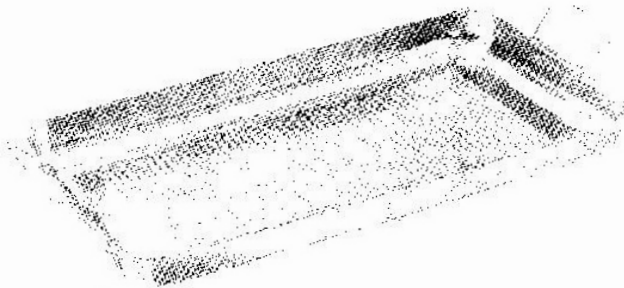

505 x 350 x 60 mm

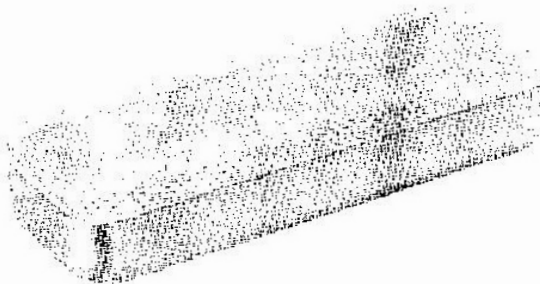

350 x 135 x 35 mm

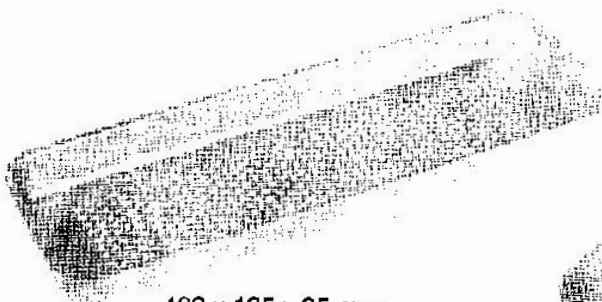

420 x 135 x 35 mm



Schimmelbusch

ø mm h mm

71-100	80	80
71-102	120	120
71-104	160	120
71-106	190	140
71-108	190	200
71-110	240	120
71-112	240	160
71-114	240	240
71-116	290	120
71-118	290	160
71-120	290	240
71-122	340	160
71-124	340	240
71-126	390	145
71-128	390	200
71-130	390	290



250 mm, 10"

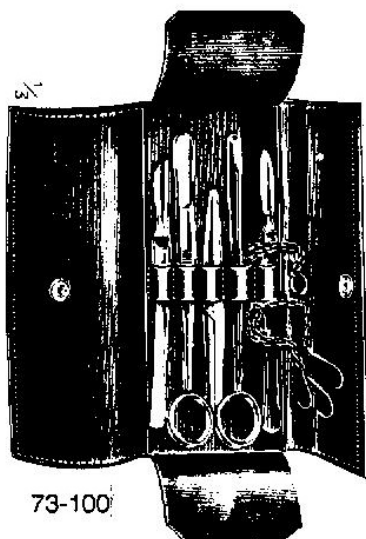

73-100

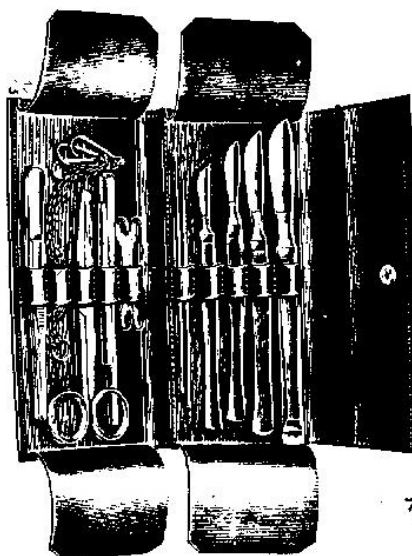

73-102

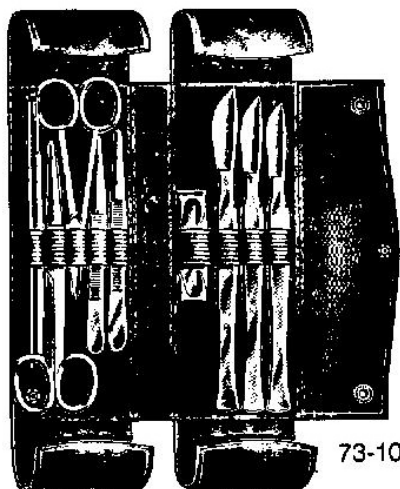

73-104



73-106

**POST MORTEM
INSTRUMENTS**

- 73-100 Dissecting Set, containing :
- 2 Scalpels
 - 1 Scissors straight probe pointed
 - 1 Dissecting forceps
 - 1 Tripple Chain & Hook
 - 1 Blow Pipe, Single
 - 2 Probes, double ended
 - 1 Probe, double ended

- 73-102 Dissecting Set, containing :
- 1 Cartilage knife with raspatory
 - 3 Scalpels
 - 1 Scissors, straight, probe pointed
 - 1 Dissecting forceps
 - 1 Blow Pipe double
 - 2 Probes, double ended
 - 1 Grappling Hook, sharp
 - 1 Tripple Chain & Hook

- 73-104 Dissecting Set, containing :
- 3 Scalpels
 - 1 Scissors, straight
 - 1 Microscopic Scissors
 - 1 Dissecting forceps
 - 1 Dissecting forceps, fine
 - 1 Dissecting needle
 - 1 Probe & Chisel
 - 1 Grappling Hook

- 73-106 Dissecting Set, containing :
- 3 Scalpels
 - 1 Cartilage knife
 - 1 Scissors, straight, probe pointed
 - 1 Dissecting forceps
 - 1 Tripple Chain & Hook
 - 1 Blow Pipe double
 - 2 Probes
 - 2 Suture Needles

SCISSORS

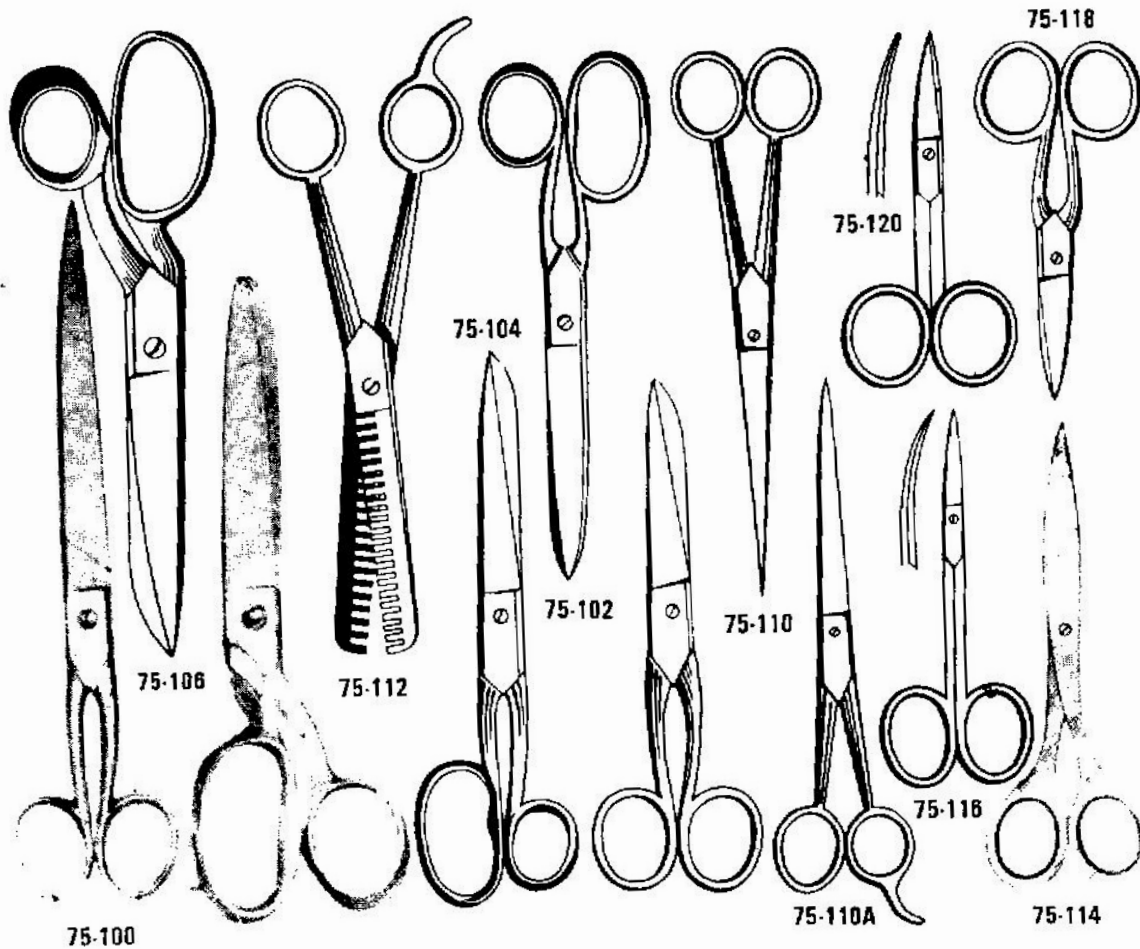

- | | | | |
|---------|--------------------------|---------|--|
| 75-100 | Paper Scissors 7-8-9" | 75-110A | Barber Scissors 7" |
| 75-102 | Household Scissors 6-7" | 75-112 | Thinning Scissors 7" |
| 75-102A | Household Scissors 6-7" | 75-114 | Household Scissors
(Plastic Ring Insertion) |
| 75-104 | G.T. Scissors 6-7" | 75-116 | Cuticle Scissors 3½4" |
| 75-106 | Tailor Scissors | 75-118 | Nail Scissors 3½4" |
| 75-108 | Tailor Scissors with tip | 75-120 | Medium Scissors 3½" |
| 75-110 | Barber Scissors 7" | | |

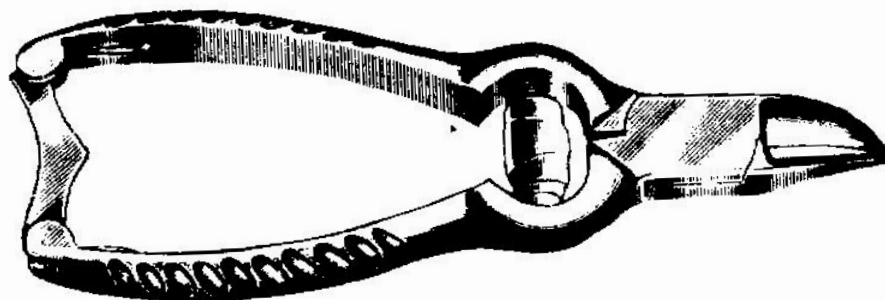

132

75-122 Nail Nipper, 4½", Concave jaws, with barrel spring, chrome plated



Zahnzangen	Extracting Forceps	English Pattern
Englische Form	Daviers	Forme Anglaise
	Forceps de Extraccion	Forma Inglesa



500/1

obere Schneide- und Eckzähne
upper centrals and canines
incisives et canines supérieures
incisivos y caninos superiores



500/2

obere Schneide- und Eckzähne
upper laterals and canines
incisives et canines supérieures
incisivos y caninos superiores

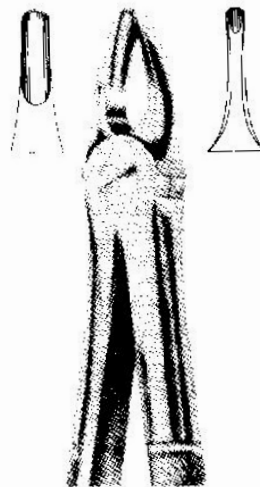

500/3

obere Schneide- und Eckzähne
upper incisors and canines
incisives et canines supérieures
incisivos y caninos superiores



500/4

untere Schneide- und Eckzähne
lower incisors and canines
incisives et canines inférieures
incisivos y caninos inferiores



500/7

obere Prämolaren
upper premolars
prémolaires supérieures
premolares superiores



500/8

untere Prämolaren
lower premolars
prémolaires inférieures
premolares inferiores

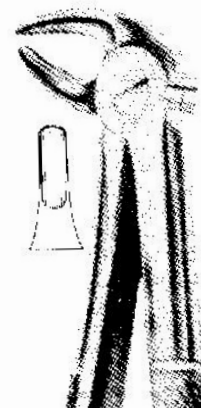

500/13

untere Prämolaren
lower premolars
prémolaires inférieures
premolares inferiores



DENTAL INSTRUMENTS

Zahnzangen	Extracting Forceps	English Pattern
Englische Form	Daviers	Forme Anglaise
	Forceps de Extracción	Forma Inglesa

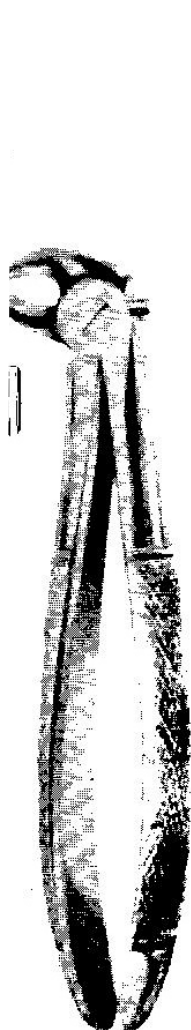

500/13 S

untere Prämolaren.
für Kinder
lower premolars.
for children
prémolaires inférieures.
pour enfants
premolares inferiores.
para niños



500/17

obere Molaren, rechts
upper molars right
molaires supérieures droites
molares superiores derechos

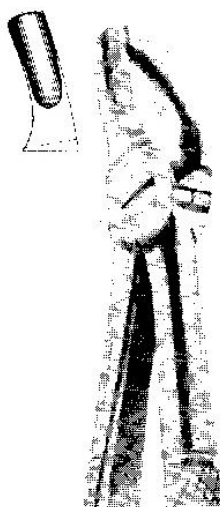

500/18

obere Molaren, links
upper molars, left
molaires supérieures gauches
molares superiores izquierdos

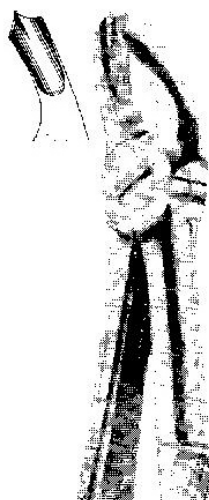

500/18 A

obere Molaren
upper molars
molaires supérieures
molares superiores



500/18 B

obere Molaren
upper molars
molaires supérieures
molares superiores

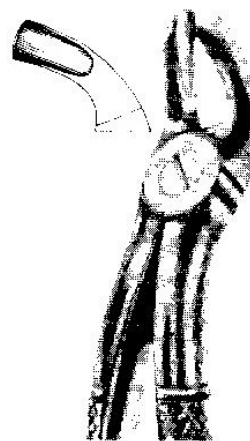

500/19

obere dritte Molaren
upper third molars
troisièmes molaires supérieures
terceros molares superiores



DENTAL INSTRUMENTS

Zahnzangen	Extracting Forceps	English Pattern
Englische Form	Daviers	Forme Anglaise
	Forceps de Extracción	Forma Inglesa

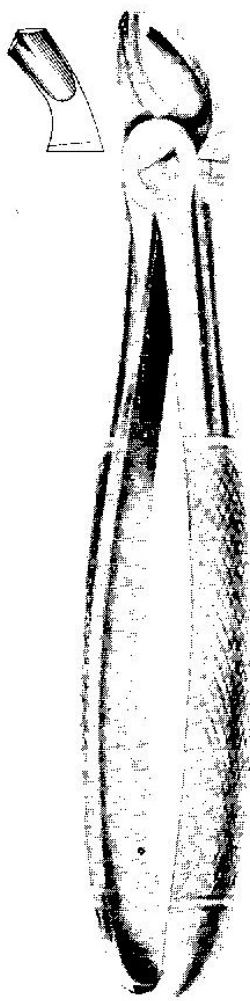

500/20
untere dritte Molaren
lower third molars
troisièmes molaires inférieures
terceros molares inferiores

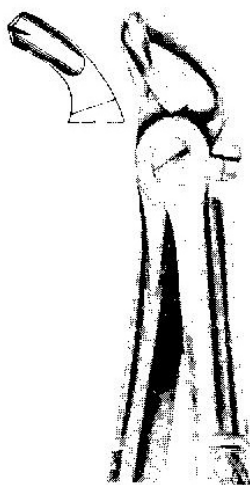

500/21
untere Molaren
lower molars
molaires inférieures
molares inferiores

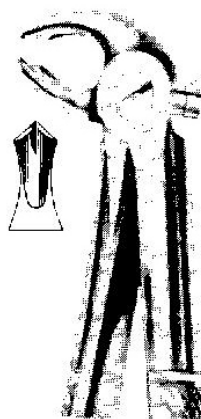

500/22
untere Molaren
lower molars
molaires inférieures
molares inferiores

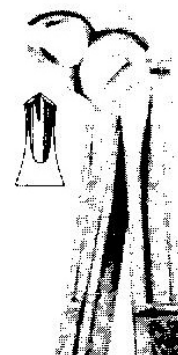

500/22 S
untere Molaren,
für Kinder
lower molars,
for children
molaires inférieures,
pour enfants
molares inferiores,
para niños

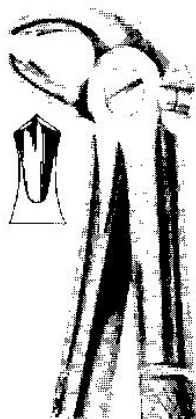

500/22 G
untere Molaren
lower molars
molaires inférieures
molares inferiores

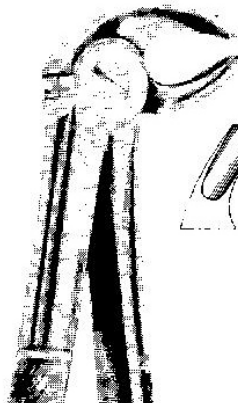

500/23
untere Molaren, rechts
lower molars, right
molaires inférieures droites
molares inferiores derechos

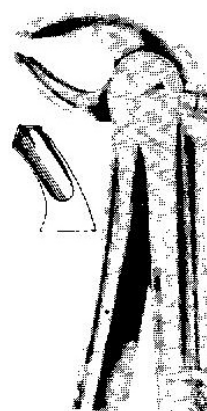

500/24
untere Molaren, links
lower molars, left
molaires inférieures gauches
molares inferiores izquierdos



Zahnzangen	Extracting Forceps	English Pattern
Englische Form	Daviers	Forme Anglaise
	Forceps de Extracción	Forma Inglesa

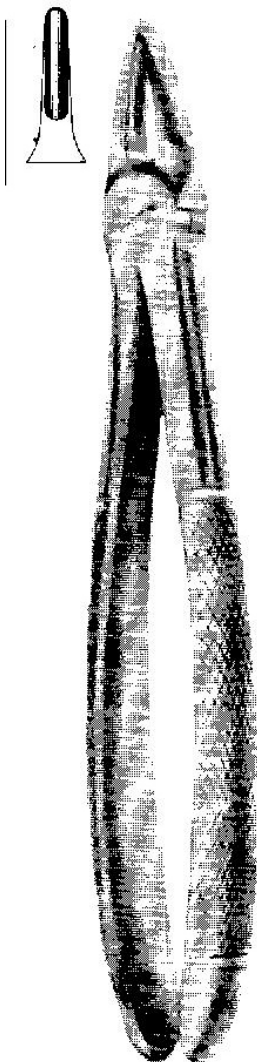

500/29

obere Wurzeln
upper roots
racines supérieures
raíces superiores

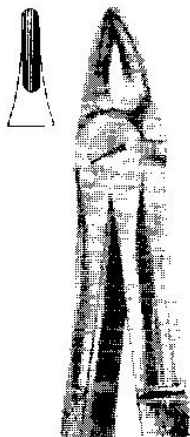

500/29 S

obere Wurzeln,
für Kinder
upper roots,
for children
racines supérieures,
pour enfants
raíces superiores,
para niños

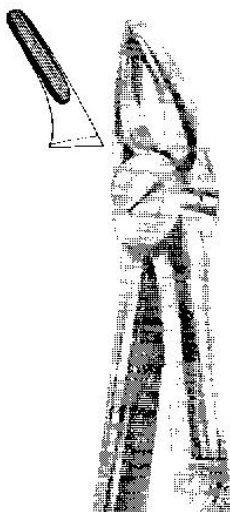

500/30

obere Wurzeln
upper roots
racines supérieures
raíces superiores



500/30 S

obere Wurzeln,
für Kinder
upper roots,
for children
racines supérieures,
pour enfants
raíces superiores,
para niños

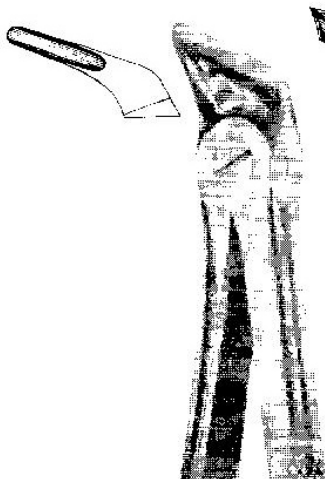

500/31

untere Wurzeln
lower roots
racines inférieures
raíces inferiores

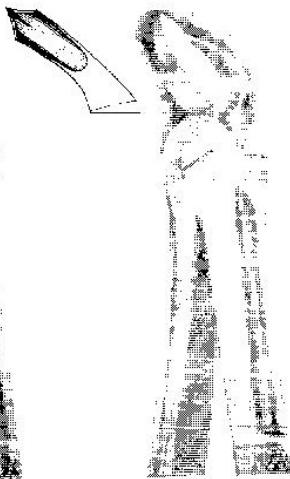

500/32

untere Molaren
lower molars
molaires inférieures
molares inferiores



Zahnzangen	Extracting Forceps	English Pattern
Englische Form	Daviers	Forme Anglaise
	Forceps de Extracción	Forma Inglesa



500/38

untere Schneide- und Eckzähne, für Kinder
lower incisors and canines, for children
incisives et canines inférieures, pour enfants
incisivos y caninos inferiores, para niños

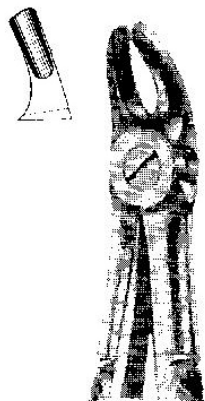

500/39

obere Molaren, für Kinder
upper molars, for children
molaires supérieures, pour enfants
molares superiores, para niños

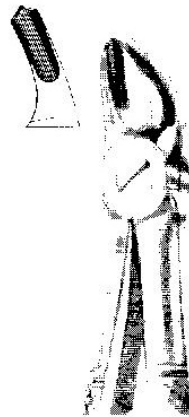

500/39 R

obere Molaren rechts, für Kinder
upper molars right, for children
molaires supérieures droites, pour enfants
molares superiores derechos, para niños



500/39 L

obere Molaren links, für Kinder
upper molars left, for children
molaires supérieures gauches, pour enfants
molares superiores izquierdos, para niños

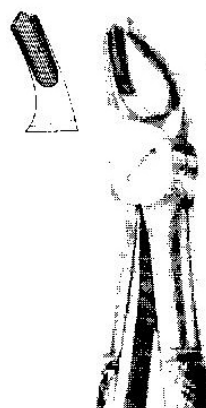

500/39 A

obere Molaren, für Kinder
upper molars, for children
molaires supérieures, pour enfants
molares superiores, para niños

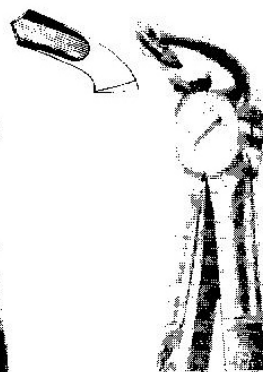

500/40

untere Molaren, für Kinder
lower molars, for children
molaires inférieures, pour enfants
molares inferiores, para niños



Zahnzangen	Extracting Forceps	English Pattern
Englische Form	Daviers	Forme Anglaise
	Forceps de Extracción	Forma Inglesa

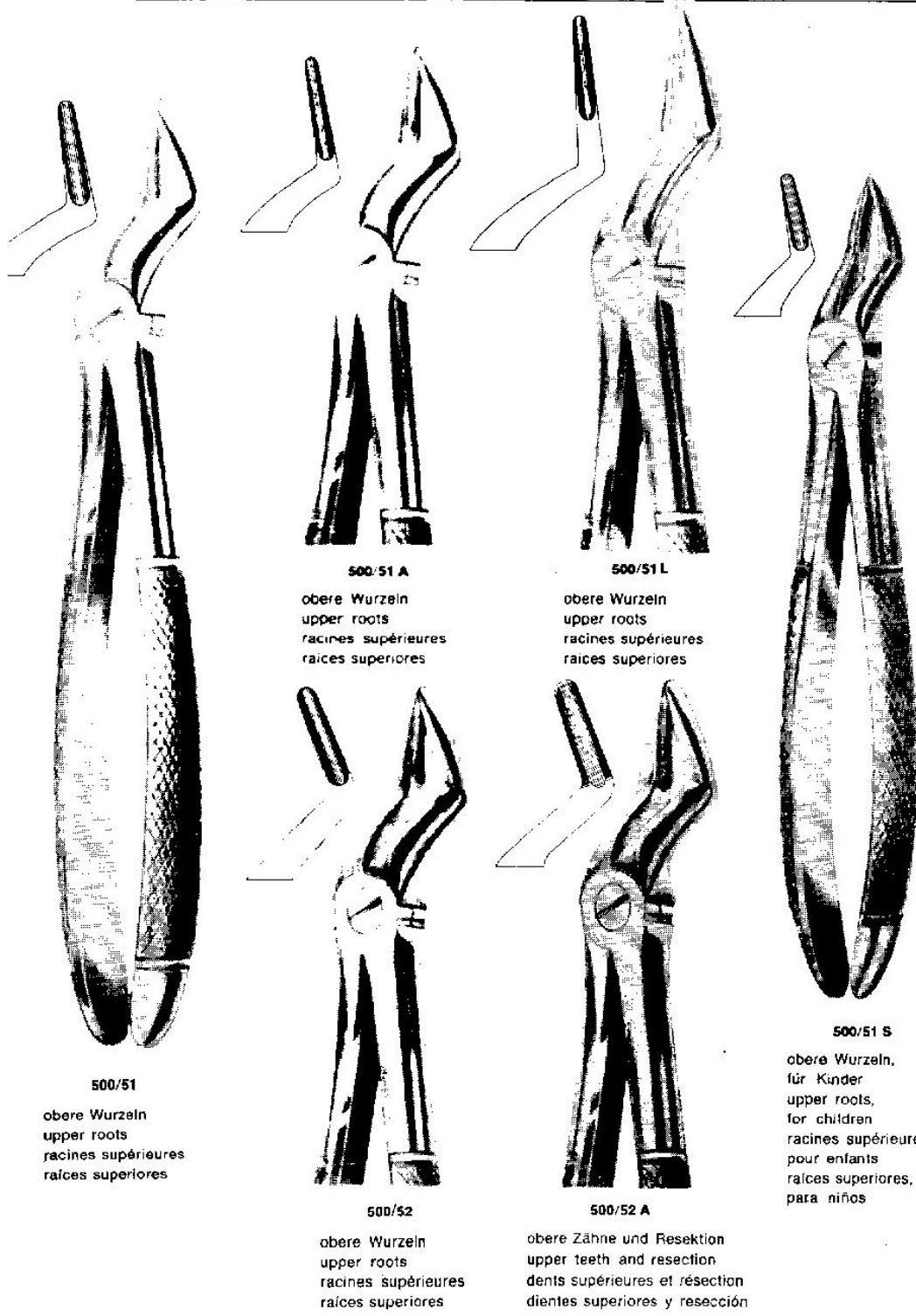

500/51
obere Wurzeln
upper roots
racines supérieures
raíces superiores

500/51 A
obere Wurzeln
upper roots
racines supérieures
raíces superiores

500/51 L
obere Wurzeln
upper roots
racines supérieures
raíces superiores

500/51 S
obere Wurzeln,
für Kinder
upper roots,
for children
racines supérieures,
pour enfants
raíces superiores,
para niños

500/52
obere Wurzeln
upper roots
racines supérieures
raíces superiores

500/52 A
obere Zähne und Resektion
upper teeth and resection
dents supérieures et résection
dientes superiores y resección



Zahnzangen	Extracting Forceps	English Pattern
Englische Form	Daviers	Forme Anglaise
	Forceps de Extracción	Forma Inglesa

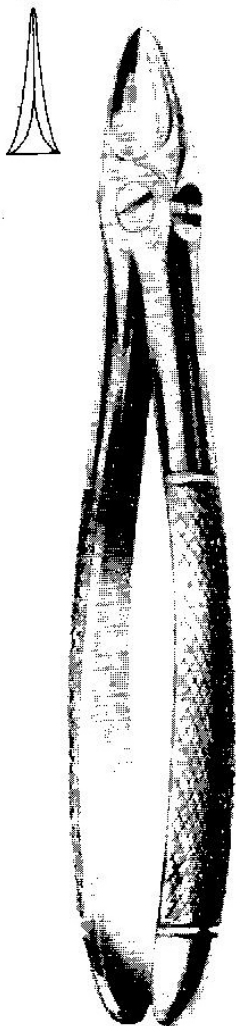

500/54
Spaltzange für obere Molaren
for separating upper molars
à séparer molaires supérieures
para separar molares superiores

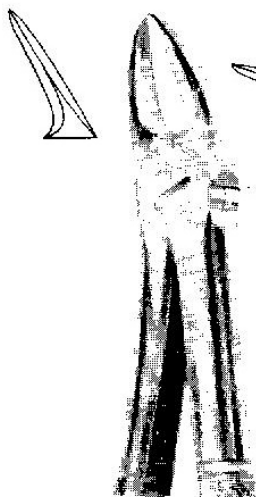

500/55
Spaltzange für obere Molaren
for separating upper molars
à séparer molaires supérieures
para separar molares superiores

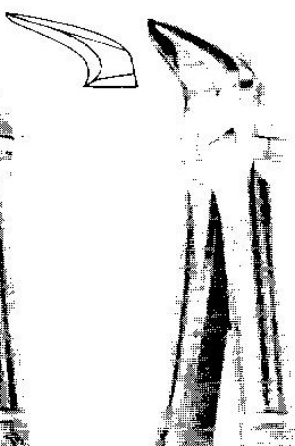

500/56
Spaltzange für untere Molaren
for separating lower molars
à séparer molaires inférieures
para separar molares inferiores

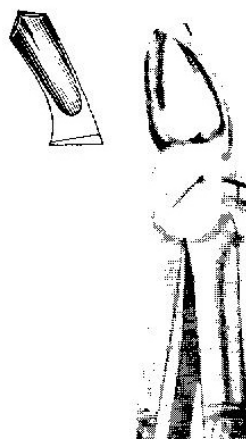

500/65 R
obere Molaren, rechts
upper molars, right
molaires supérieures droites
molares superiores derechos

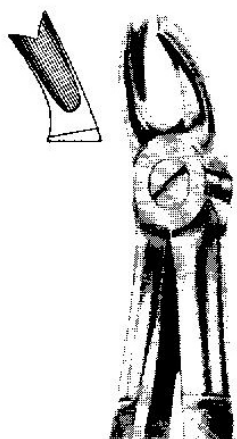

500/65 L
obere Molaren, links
upper molars, left
molaires supérieures gauches
molares superiores izquierdos

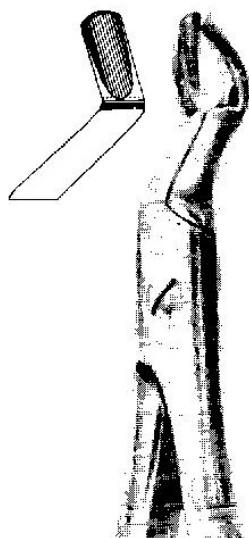

500/67
obere dritte Molaren
upper third molars
troisièmes molaires supérieures
terceros molares superiores

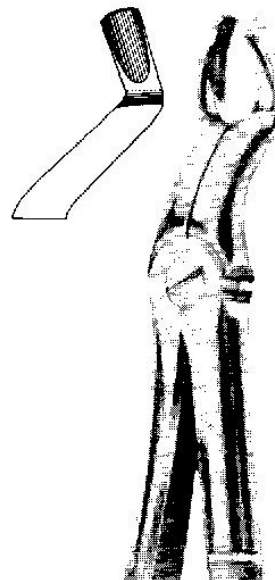

500/67 A
obere dritte Molaren
upper third molars
troisièmes molaires supérieures
terceros molares superiores



Zahnzangen	Extracting Forceps	English Pattern
Englische Form	Daviers	Forme Anglaise
	Forceps de Extracción	Forma Inglesa

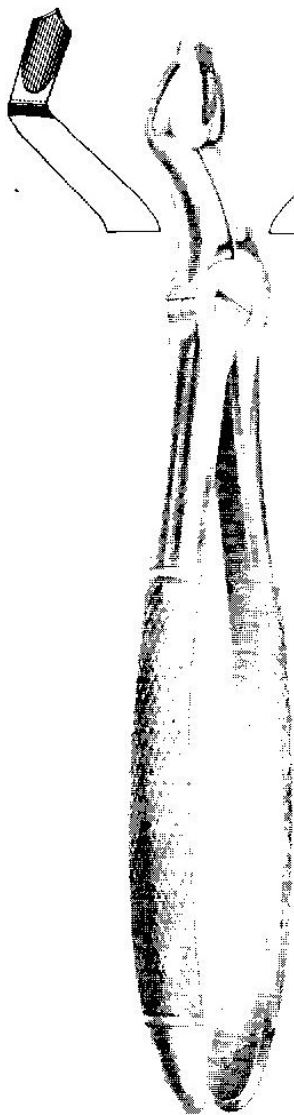

500/67 1/2 R
obere dritte Molaren, rechts
upper third molars, right
troisièmes molaires
supérieures, droites
terceros molares
superiores, derechos

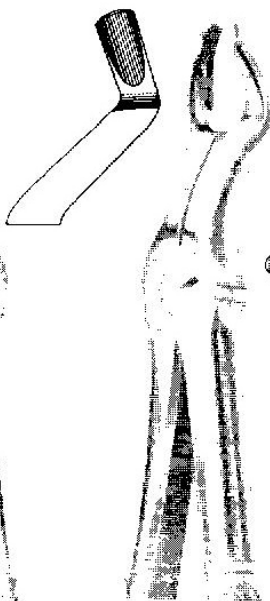

500/67 1/2 L
obere dritte Molaren, links
upper third molars, left
troisièmes molaires
supérieures, gauches
terceros molares
superiores, izquierdos

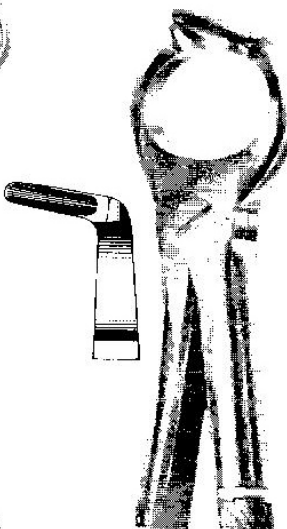

500/68
untere Wurzeln
lower roots
racines inférieures
raíces inferiores

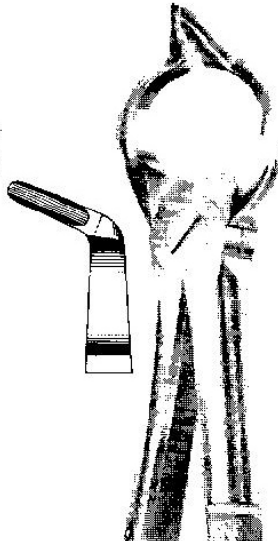

500/68 A
untere Wurzeln
lower roots
racines inférieures
raíces inferiores

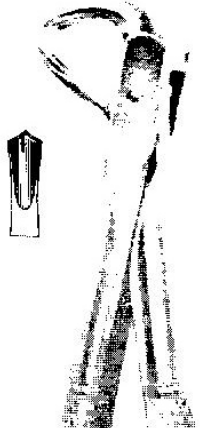

500/73
untere Molaren
lower molars
molaires inférieures
molares inferiores

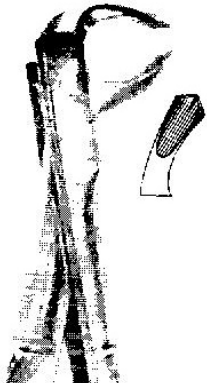

500/73 R
untere Molaren, rechts
lower molars, right
molaires inférieures
droites
molares inferiores
derechos

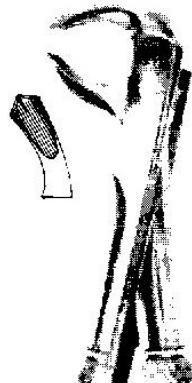

500/73 L
untere Molaren, links
lower molars, left
molaires inférieures
gauches
molares inferiores
izquierdos



Zahnzangen	Extracting Forceps	English Pattern
Englische Form	Daviers	Forme Anglaise
	Forceps de Extracción	Forma Inglesa

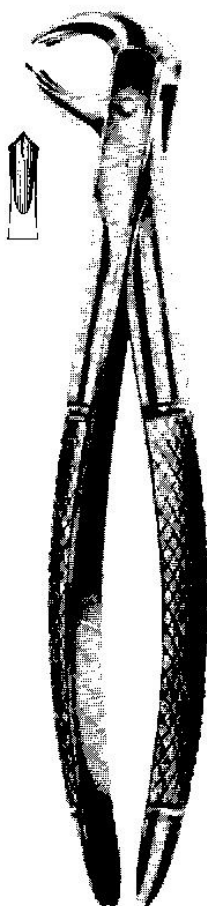

500/73 A
untere Molaren
lower molars
molaires inférieures
molares inferiores

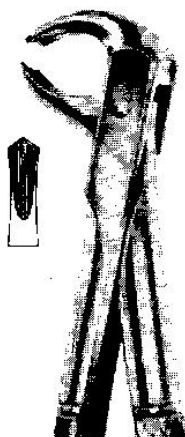

500/73 S
untere Molaren
lower molars
molaires inférieures
molares inferiores

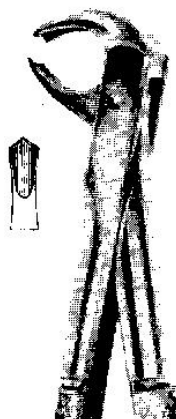

500/73 B
untere Molaren,
für Kinder
lower molars,
for children
molaires inférieures,
pour enfants
molares inferiores,
para niños



500/73 K
untere Molaren,
für Kinder
lower molars,
for children
molaires inférieures,
pour enfants
molares inferiores,
para niños

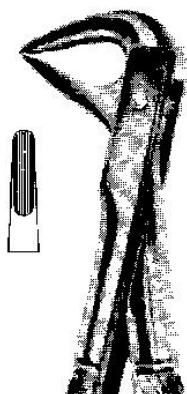

500/74
untere Wurzeln
lower roots
racines inférieures
raíces inferiores

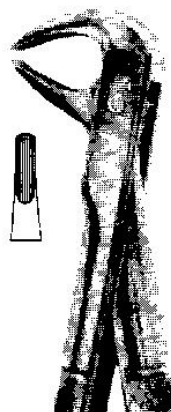

500/74 D
untere Wurzeln
lower roots
racines inférieures
raíces inferiores



Zahnzangen	Extracting Forceps	English Pattern
Englische Form	Daviers	Forme Anglaise
	Forceps de Extracción	Forma Inglesa

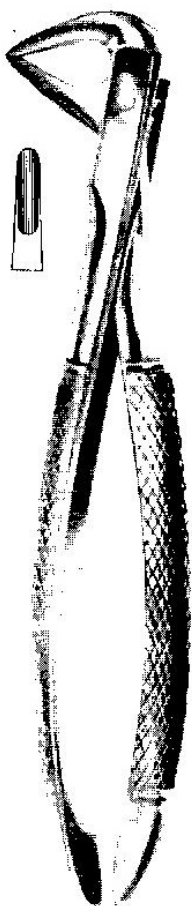

500/74 M
 untere Wurzeln
 lower roots
 racines inférieure
 raíces inferiores



500/74 N
 untere Wurzeln
 lower roots
 racines inférieures
 raíces inferiores

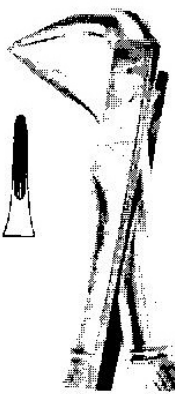

500/74 XN
 untere Wurzeln und eng-
 stehende Schneidezähne
 lower roots and crowded
 incisors
 racines inférieures et
 incisives surdents
 raíces inferiores e incisivos
 supernumerarios

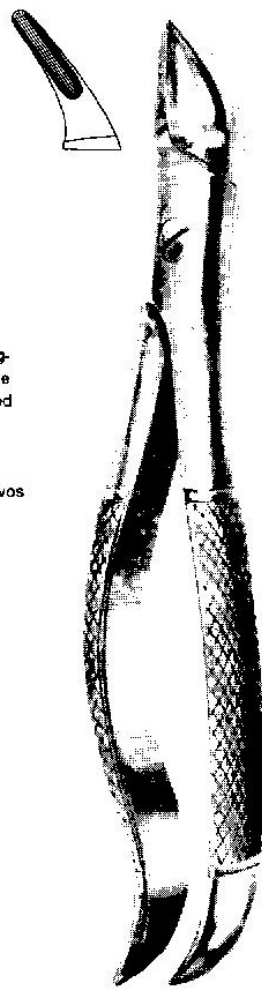

500/76 N
 obere Wurzeln
 upper roots
 racines supérieures
 raíces superiores

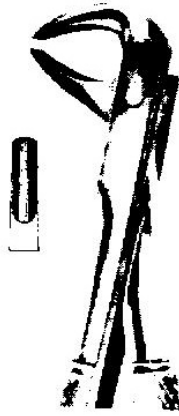

500/75
 untere Pramolaren
 lower premolars
 prémolaires inférieures
 premolares inferiores

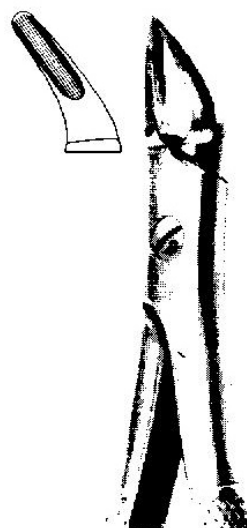

500/76
 obere Wurzeln
 upper roots
 racines supérieures
 raíces superiores



Zahnzangen	Extracting Forceps	English Pattern	
	Englische Form	Daviers	Forme Anglaise
		Forceps de Extracción	Forma Inglesa

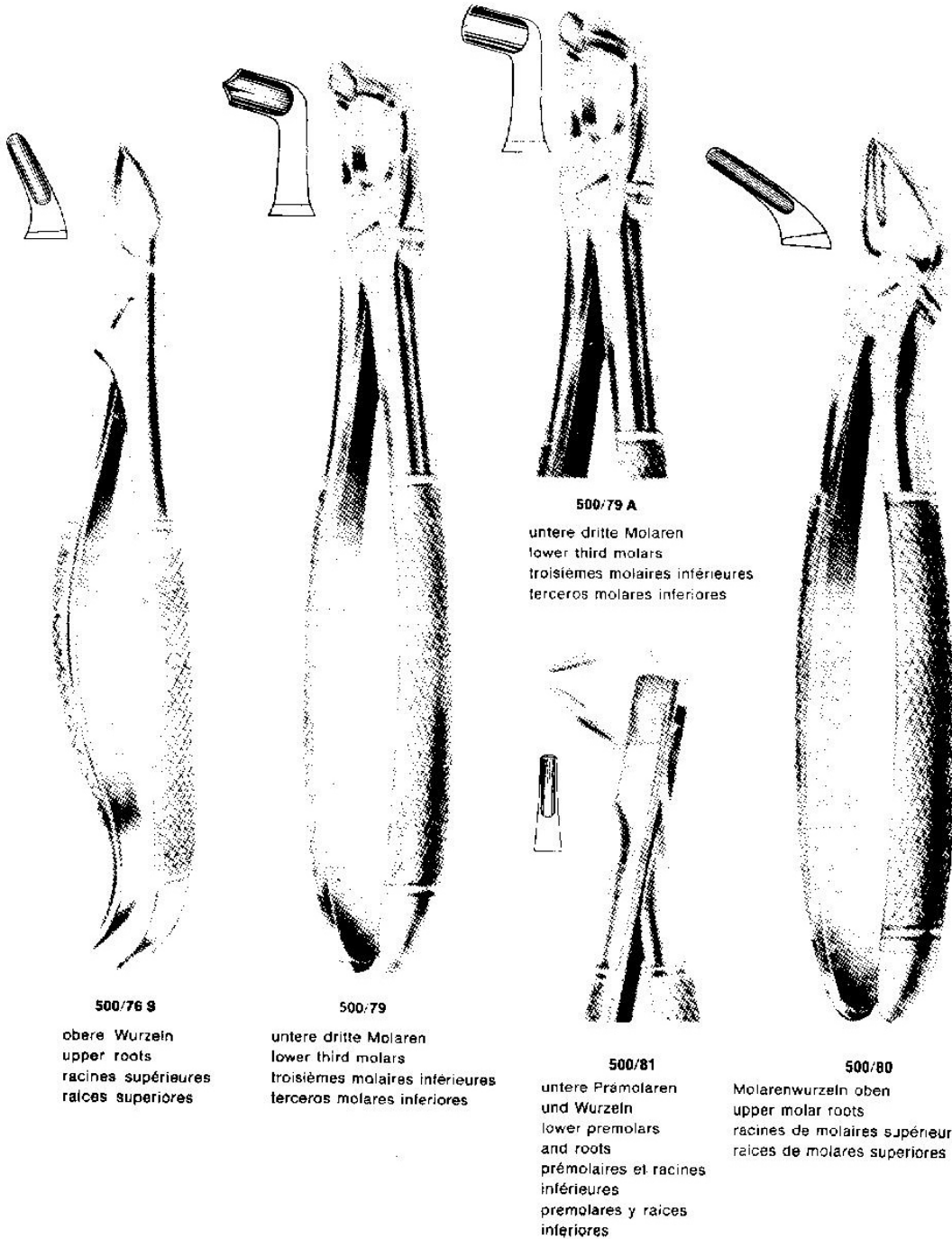

500/76 S

obere Wurzeln
upper roots
racines supérieures
raíces superiores

500/79

untere dritte Molaren
lower third molars
troisièmes molaires inférieures
terceros molares inferiores

500/79 A

untere dritte Molaren
lower third molars
troisièmes molaires inférieures
terceros molares inferiores

500/81

untere Prämolaren
und Wurzeln
lower premolars
and roots
prémolaires et racines
inférieures
premolares y raíces
inferiores

500/80

Molarenwurzeln oben
upper molar roots
racines de molaires supérieures
raíces de molares superiores

Zahnzangen für Kinder
 Forceps for children
 Daviers pour enfants
 Forceps para niños

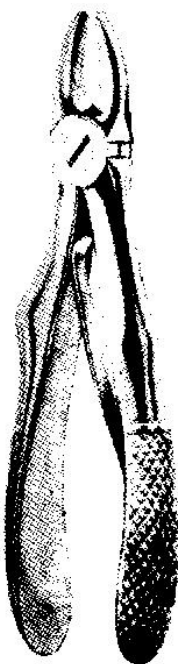

560/Klein
570/Klein
 obere Schneidezahne
 upper incisors
 incisives supérieures
 incisivos superiores

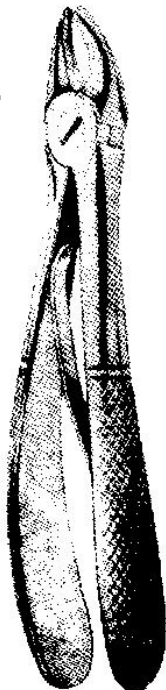

561/Klein
571/Klein
 obere Prämolaren
 upper premolars
 prémolaires supérieures
 premolares superiores

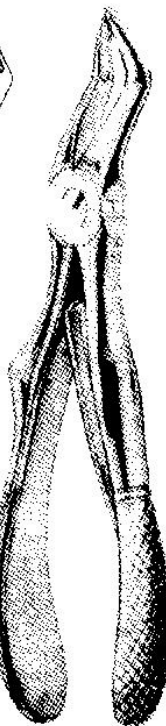

562/Klein
572/Klein
 obere Wurzeln
 upper roots
 racines supérieures
 raíces superiores

560 – 563
 mit Feder
 with spring
 avec ressort
 con resorte

570 – 573
 ohne Feder
 without spring
 sans ressort
 sin resorte

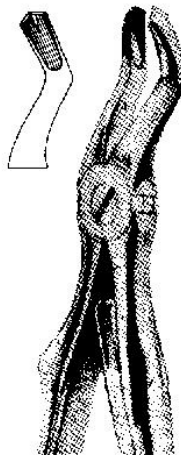

563/Klein
573/Klein
 obere Molaren
 upper molars
 molaires supérieures
 molares superiores

**Zahnzangen und
Zahnpinzetten
für Kinder**

Forceps and Tweezers for children
Daviers et pinces pour enfants
Forceps y pinzas para niños

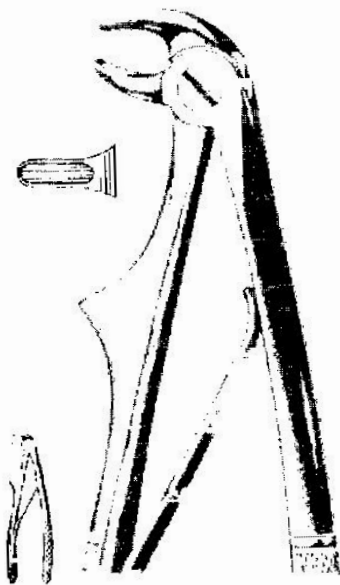

565/Klein
575/Klein
untere Schneidezähne
lower incisors
incisives inférieures
incisivos inferiores

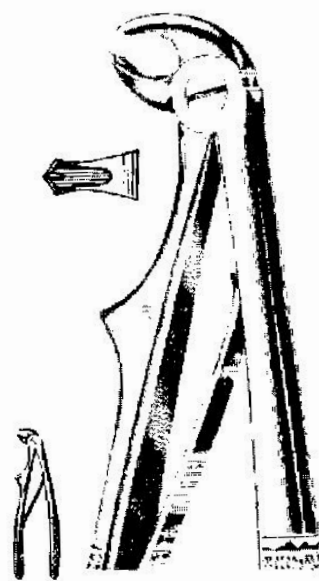

566/Klein
576/Klein
untere Molaren
lower molars
molaires inférieures
molares inferiores

565 – 567
mit Feder
with spring
avec ressort
con resorte

575 – 577
ohne Feder
without spring
sans ressort
sin resorte

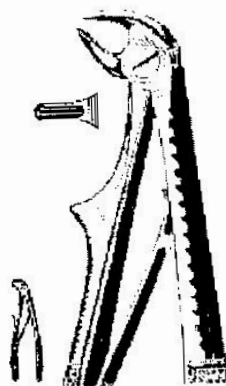

567/Klein
577/Klein
untere Wurzeln
lower roots
racines inférieures
raíces inferiores



500
Albracht

582
Albracht

Milchzähne
deciduous teeth
dents temporaires
dientes temporales

Wurzelsplitterzangen

Root Splinter Forceps
Pincas a fragments
Pinzas para fragmentos

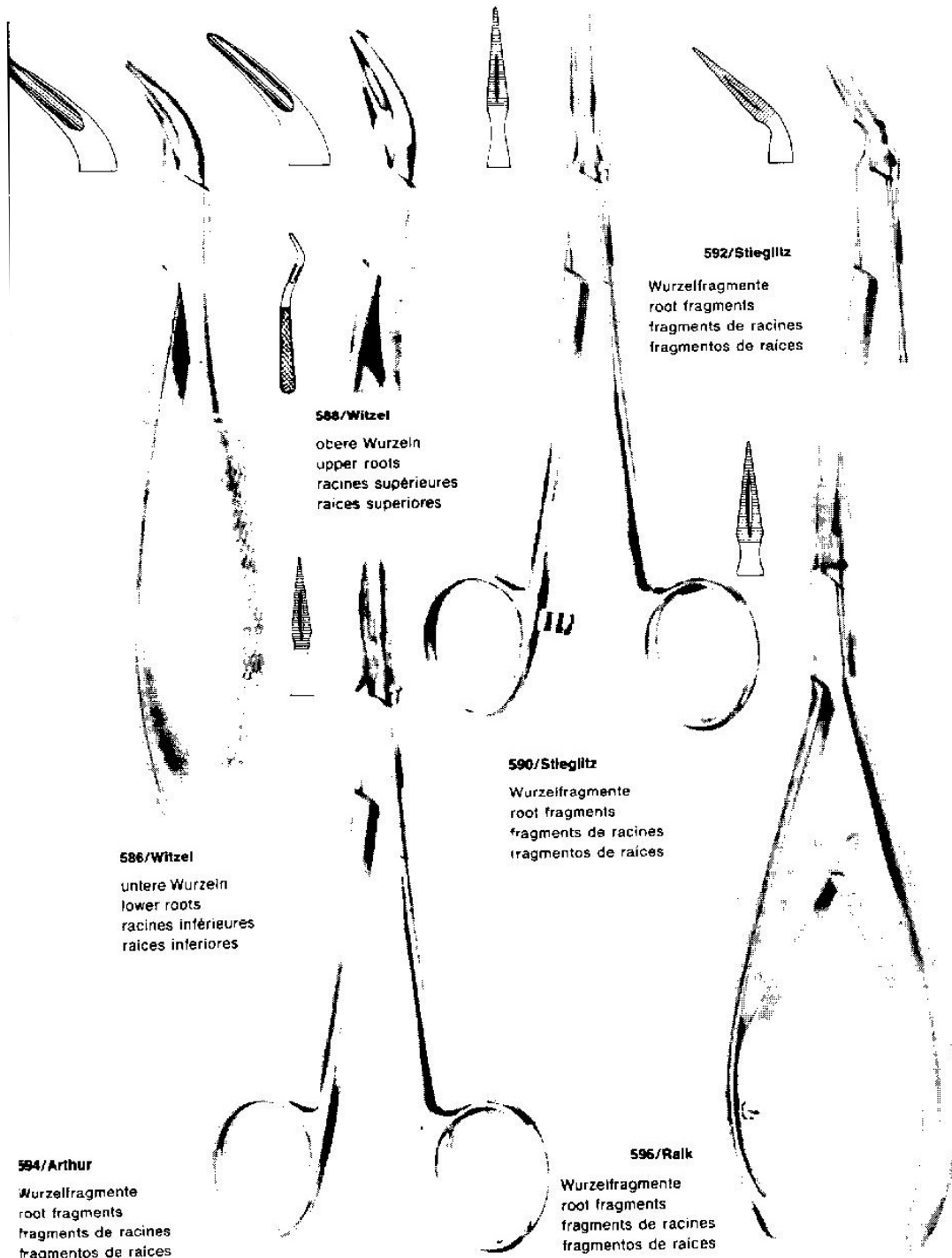

Zahnzangen	Extracting Forceps	American Pattern
Amerikanische Form	Daviers	Forme américaine
	Forceps de Extracción	Forma americana

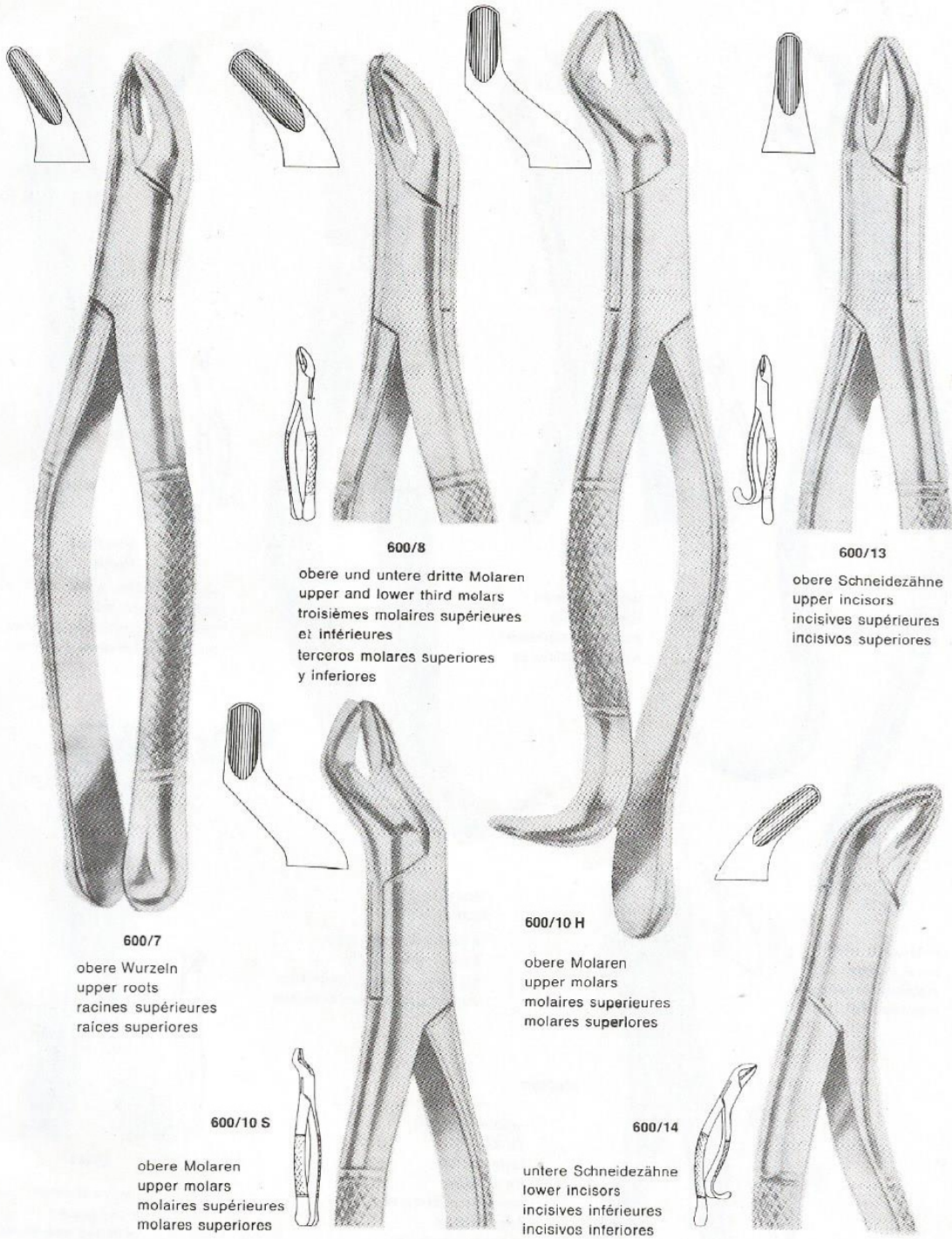

600/7
obere Wurzeln
upper roots
racines supérieures
raíces superiores

600/8
obere und untere dritte Molaren
upper and lower third molars
troisièmes molaires supérieures
et inférieures
terceros molares superiores
y inferiores

600/13
obere Schneidezähne
upper incisors
incisives supérieures
incisivos superiores

600/10 H
obere Molaren
upper molars
molaires supérieures
molares superiores

600/10 S
obere Molaren
upper molars
molaires supérieures
molares superiores

600/14
untere Schneidezähne
lower incisors
incisives inférieures
incisivos inferiores



DENTAL INSTRUMENTS

Zahnzangen	Extracting Forceps	American Pattern
Amerikanische Form	Daviers	Forme américaine
	Forceps de Extracción	Forma americana

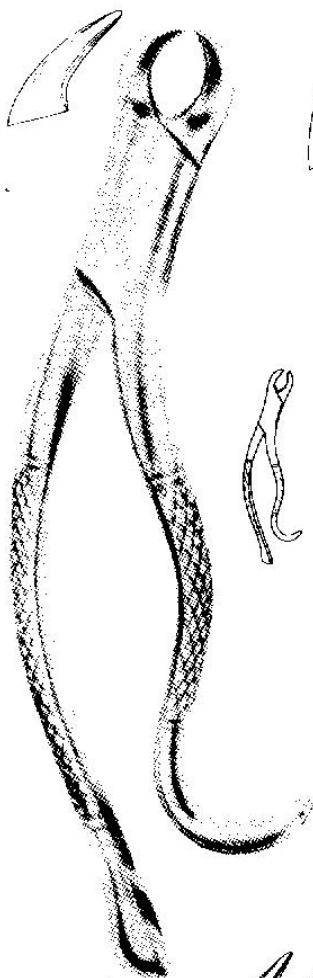

**600/15
Harris**
untere Molaren
lower molars
molaires inférieures
molares inferiores

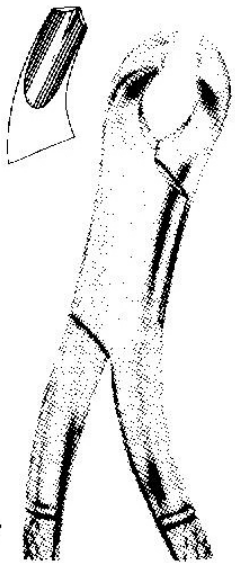

**600/18 L
Harris**
obere Molaren, links
upper molars, left
molaires supérieures gauches
molares superiores izquierdos

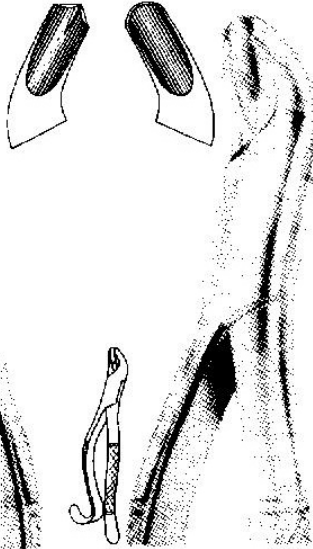

**600/18 R
Harris**
obere Molaren, rechts
upper molars, right
molaires supérieures droites
molares superiores derechos

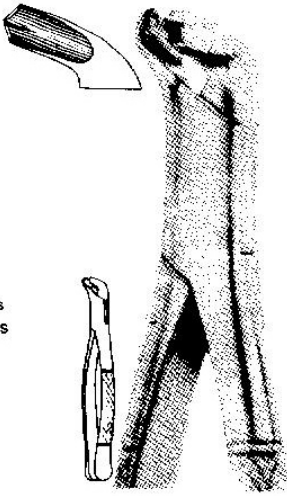

600/17
untere Molaren
lower molars
molaires inférieures
molares inferiores

600/16
untere Molaren
lower molars
molaires inférieures
molares inferiores

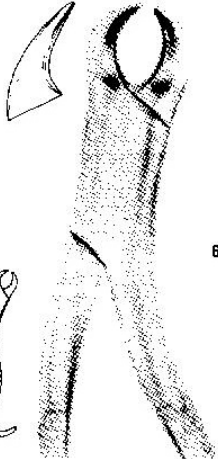

600/16 S
untere Molaren,
für Kinder
lower molars,
for children
molaires inférieures,
pour enfants
molares inferiores,
para niños



DENTAL INSTRUMENTS

Zahnzangen	Extracting Forceps	American Pattern
Amerikanische Form	Daviers	Forme américaine
	Forceps de Extracción	Forma americana

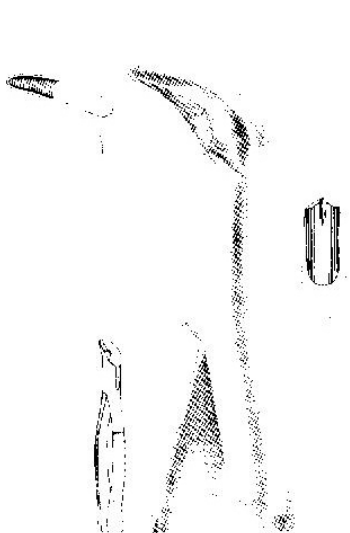

600/37

untere Zähne und Wurzeln
lower anteriors and roots
dents et racines inférieures
dientes y raíces inferiores

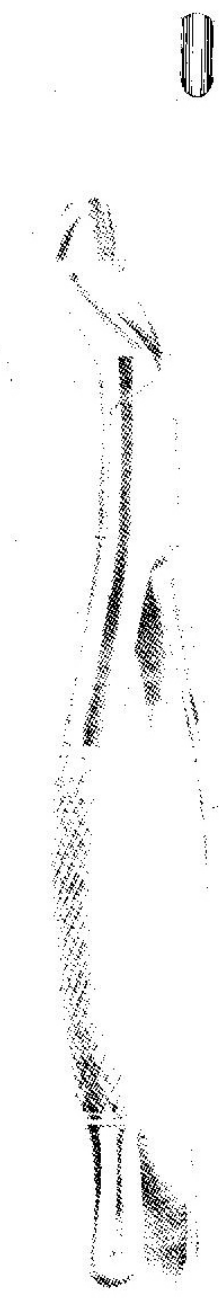

600/53 R

obere Molaren, rechts
upper molars, right
molaires supérieures droites
molares superiores derechos



600/53 L

obere Molaren, links
upper molars, left
molaires supérieures gauches
molares superiores izquierdos

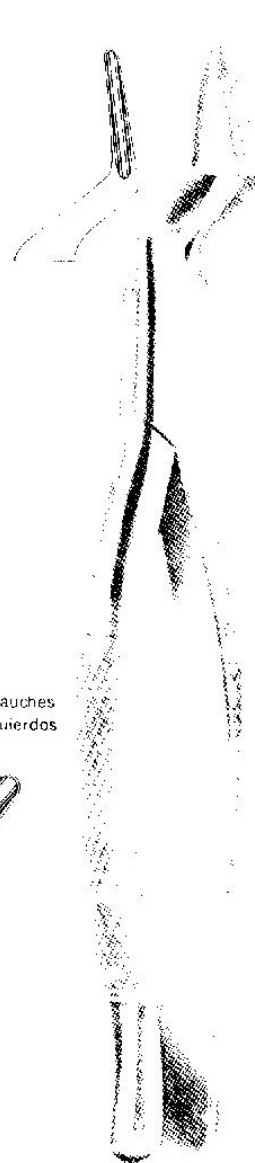

600/65

obere Schneidezähne und Wurzeln
upper incisors and roots
incisives et racines supérieures
incisivos y raíces superiores



600/38

obere Zähne und Wurzeln
upper anteriors and roots
dents et racines supérieures
dientes y raíces superiores

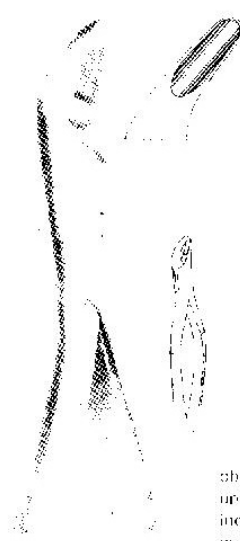

600/62

Schneidezähne, Prämolaren, Milchzähne
incisors, premolars, deciduous teeth
incisives, prémolaires, dents de lait
incisivos, premolares, dientes de leche



Zahnzangen	Extracting Forceps	American Pattern
Amerikanische Form	Daviers	Forme américaine
	Forceps de Extracción	Forma americana

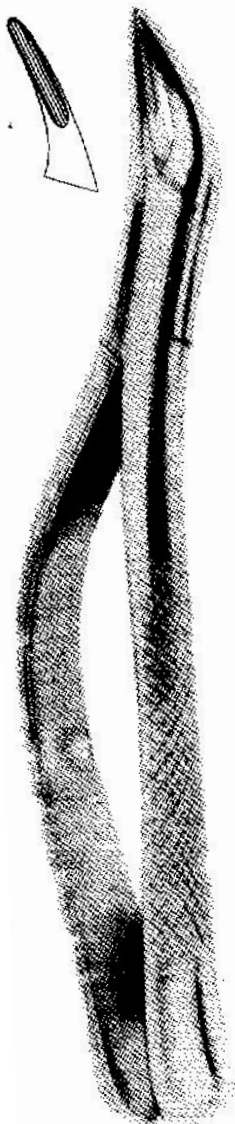

600/69 Tomes
obere und untere Wurzeln
upper and lower roots
racines supérieures et inférieures
raíces superiores y inferiores

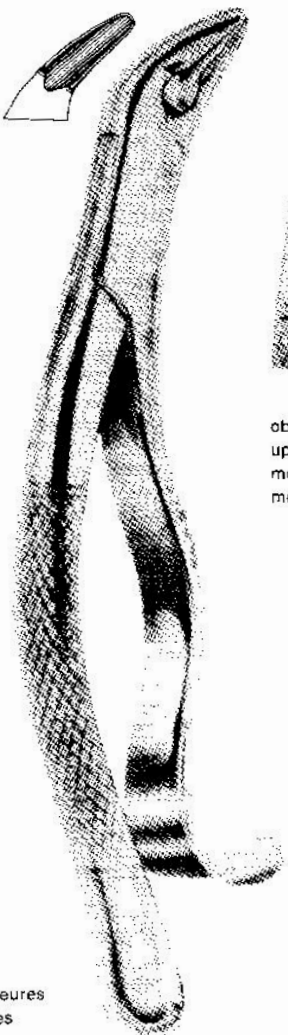

600/85 Thomas
untere Eckzähne, Prämolaren, Molaren
lower canines, premolars and molars
canines, prémolaires, molaires infér.
caninos, premolares, molares infer.

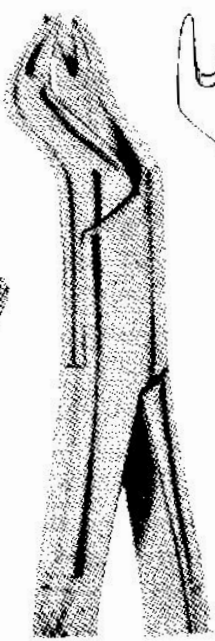

600/88 R Nevius
obere Molaren, rechts
upper molars, right
molaires supérieures droites
molares superiores derechos

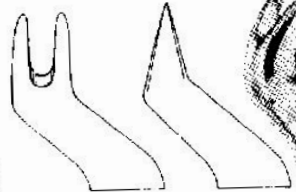

600/85 A Thomas
untere Eckzähne, Prämolaren, Molaren
lower canines, premolars and molars
canines, prémolaires, molaires infér.
caninos, premolares, molares infer.



600/88 L Nevius
obere Molaren, links
upper molars, left
molaires supérieures gauches
molares superiores izquierdas



Zahnzangen	Extracting Forceps	American Pattern
Amerikanische Form	Daviers	Forme américaine
	Forceps de Extracción	Forma americana

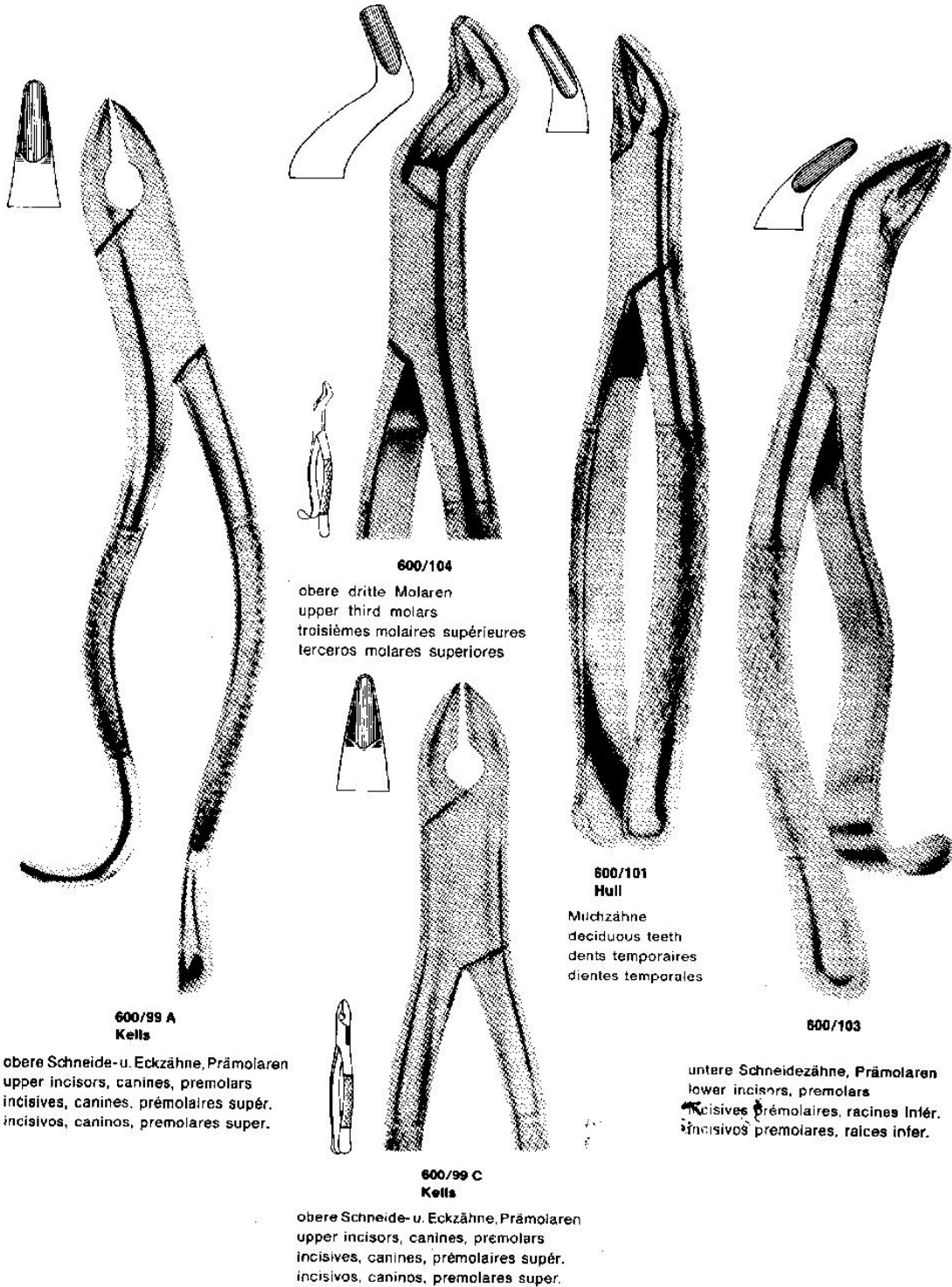



Zahnzangen	Extracting Forceps	American Pattern
Amerikanische Form	Daviers	Forme américaine
	Forceps de Extracción	Forma americana

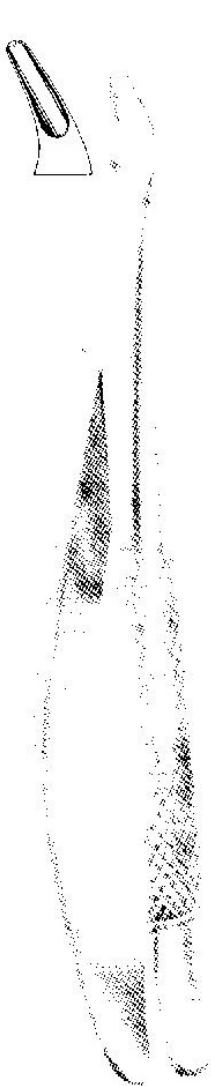

**600/150
Cryer**

obere Schneidezähne, Prämolaren
und Wurzeln
upper incisors, premolars, roots
incisives, prémolaires, racines supér.
incisivos, premolares, raíces super.

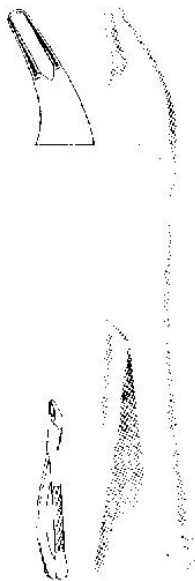

**600/150 A
Cryer**

obere Schneidezähne, Prämolaren
und Wurzeln
upper incisors, premolars, roots
incisives, prémolaires, racines supér.
incisivos, premolares, raíces super.

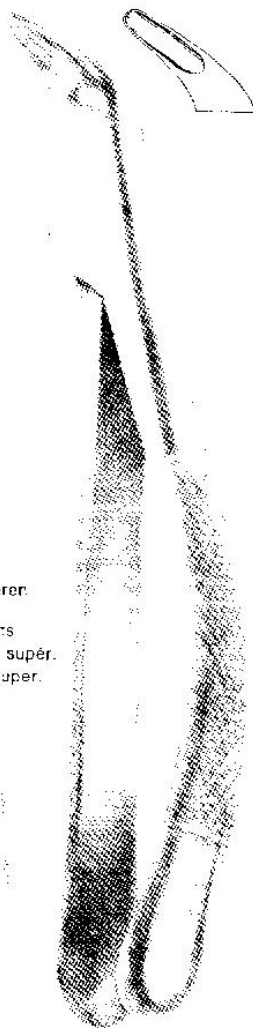

**600/151
Cryer**

untere Schneidezähne, Prämolaren
und Wurzeln
lower incisors, premolars, roots
incisivos, prémolares, racines infér.
incisivos, premolares, raíces infer.



**600/151 A
Cryer**

untere Schneidezähne, Prämolaren
und Wurzeln
lower incisors, premolars, roots
incisivos, prémolaires, racines infér.
incisivos, premolares, raíces infer.

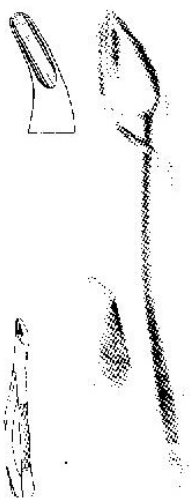

**600/150 S
Cryer**

obere Zähne, für Kinder
upper teeth, for children
dents supérieures, pour enfants
dientes superiores, para niños



**600/151 S
Cryer**

untere Zähne, für Kinder
lower teeth, for children
dents inférieures, pour enfants
dientes inferiores, para niños



Zahnzangen	Extracting Forceps	American Pattern
Amerikanische Form	Daviers	Forme américaine
	Forceps de Extracción	Forma americana



600/203
untere Schneidezähne und Wurzeln
lower incisors and roots
incisivos et racines inférieures
incisivos y raíces inferiores

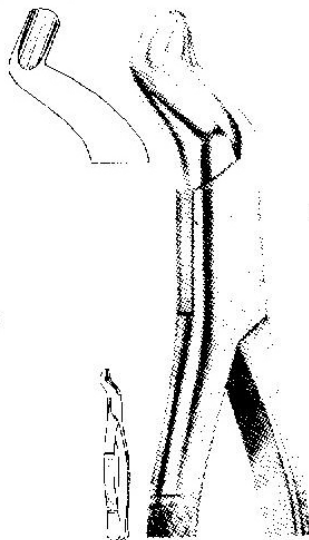

600/210 S
obere dritte Molaren
upper third molars
troisième molaires
supérieures
terceros molares
superiores

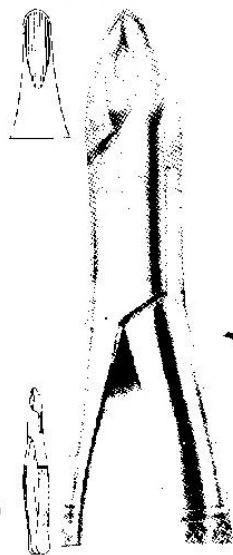

600/201
obere Schneide- u. Eckzähne, Premolaren
upper incisors, canines, premolars
incisives, canines, prémolaires supér.
incisivos, caninos, premolares super.

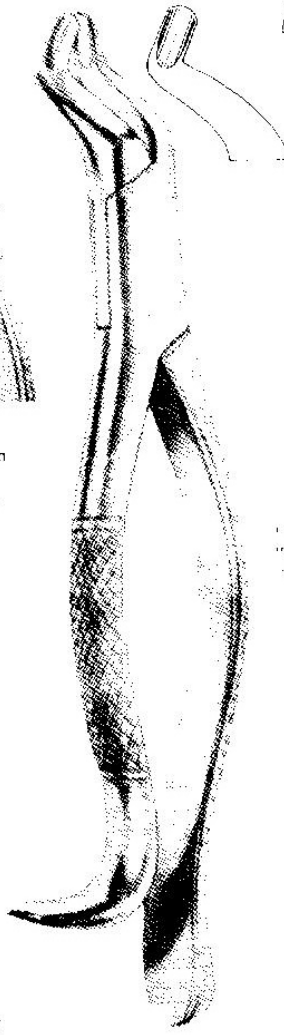

600/210 H
obere dritte Molaren
upper third molars
troisième molaires supérieures
terceros molares superiores

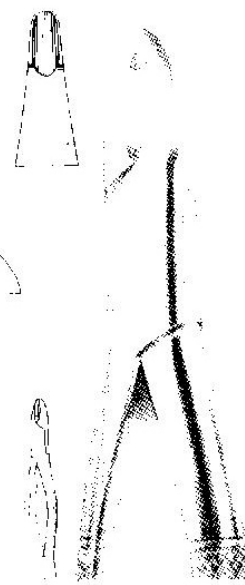

600/213
obere Schneide- und Eckzähne
upper centrals and canines
incisivos et canines supérieures
incisivos y caninos superiores

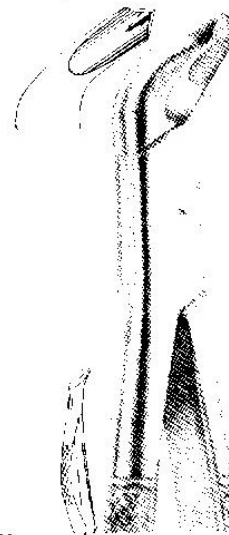

600/217
untere Molaren
lower molars
molaires inférieures
molares inferiores



Zahnzangen	Extracting Forceps	American Pattern
Amerikanische Form	Daviers	Forme américaine
	Forceps de Extracción	Forma americana

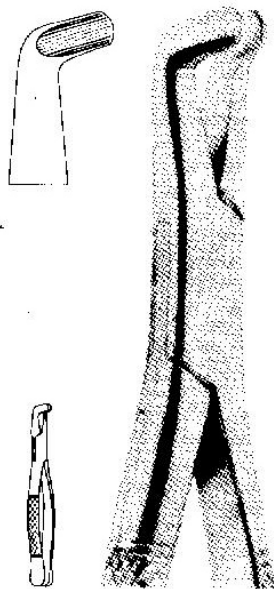

600/222

untere dritte Molaren
lower third molars
troisièmes molaires inférieures
terceros molares inferiores

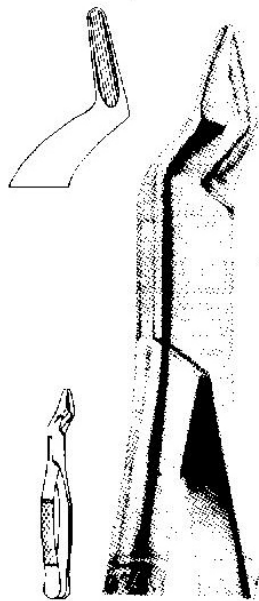

600/286

obere Schneidezähne und Wurzeln
upper incisors and roots
incisives et racines supérieures
incisivos y raíces superiores



600/287

untere Molaren
lower molars
molaires inférieures
molares inferiores

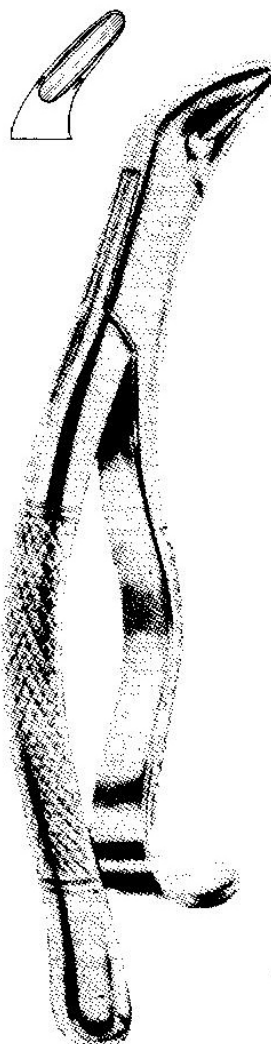

600/288

untere Eckzähne und Prämolaren
lower canines and premolars
canines, prémolaires inférieures
caninos, premolares inferiores



Zahnzangen mit Paßformgriff	Extracting Forceps Daviers Forceps de.Extracción	with fitting handles avec manche d'ajustage con mango adaptado a la mano
---------------------------------------	--	--

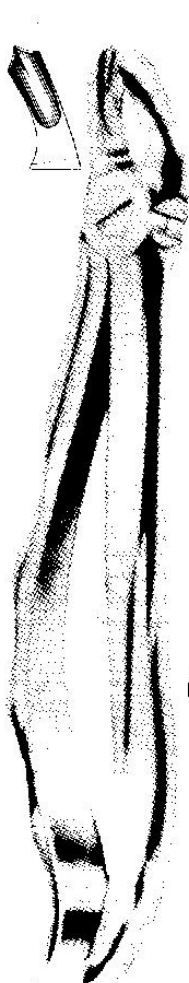

650/17
obere Molaren, rechts
upper molars, right
molaires supérieures droites
molares superiores derechos

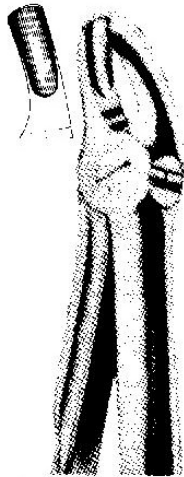

650/18
obere Molaren links
upper molars, left
molaires supérieures gauches
molares superiores izquierdos

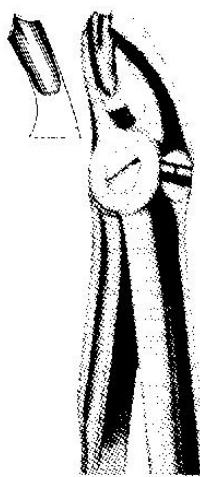

650/18 A
obere Molaren
upper molars
molaires supérieures
molares superiores



650/18 B
obere Molaren
upper molars
molaires supérieures
molares superiores



650/19
obere dritte Molaren
upper third molars
troisièmes molaires
supérieures
terceros molares
superiores

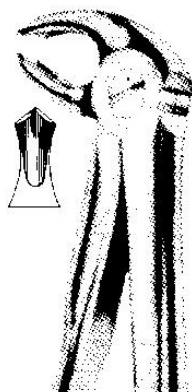

650/22
untere Molaren
lower molars
molaires inférieures
molares inferiores

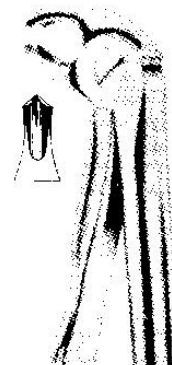

650/22 S
untere Molaren,
für Kinder
lower molars,
for children
molaires inférieures
pour enfants
molares inferiores,
para niños



Zahnzangen	Extracting Forceps	with fitting handles
mit Paßformgriff	Daviers	avec manche d'ajustage
	Forceps de Extracción	con mango adaptado a la mano

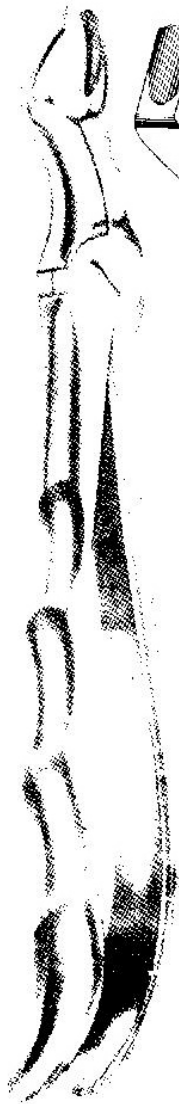

650/67 1/2 R

obere dritte Molaren rechts
upper third molars, right
troisièmes molaires
supérieures, droites
terceros molares
superiores, derechos

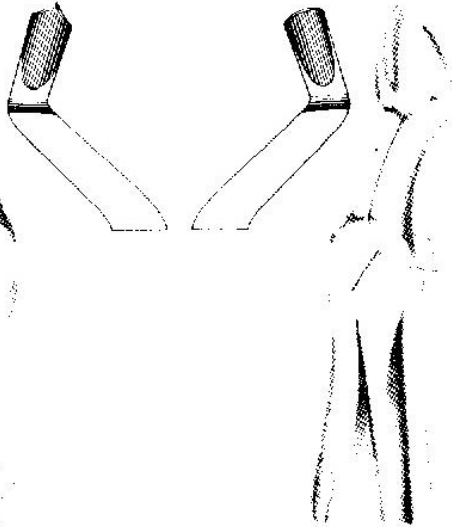

650/67 1/2 L

obere dritte Molaren, links
upper third molars, left
troisièmes molaires
supérieures, gauches
terceros molares
superiores, izquierdos

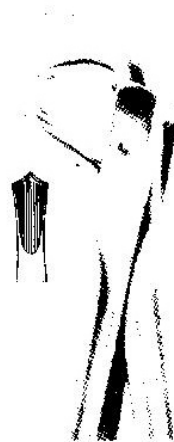

650/73

untere Molaren
lower molars
molaires inférieures
molares inferiores



650/74

untere Wurzeln
lower roots
racines inférieures
raíces inferiores



650/74 M

untere Wurzeln
lower roots
racines inférieures
raíces inferiores

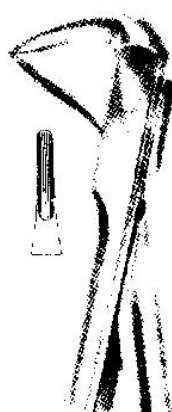

650/74 N

untere Wurzeln
lower roots
racines inférieures
raíces inferiores

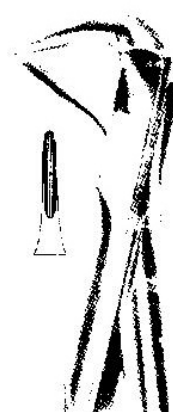

650/74 XN

untere Wurzeln und eingestehende Schneidezähne
lower roots and crowded incisors
racines inférieures et incisives surdentés
raíces inferiores e incisivos supernumerarios



Wurzelheber Root elevators
Elévateurs à racines
Elevadores para raíces



680/1
Bein 2 mm



680/2
Bein 3 mm

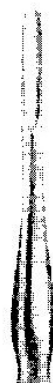

680/3
Bein 4 mm



680/4
Bein 2.5 mm



680/5
Bein 3 mm



680/6
Bein 4 mm



680/7
White



680/8
White



680/9
Berten



Wurzelheber Root elevators
Elévateurs à racines
Elevadores para raíces

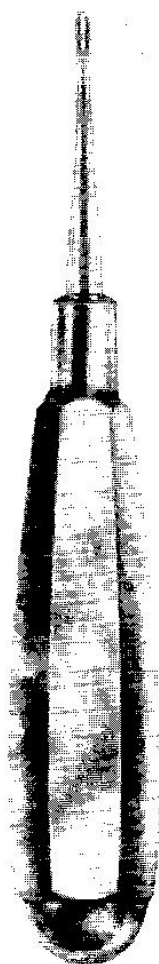

710/1
Apical 301

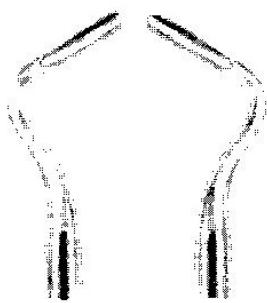

710/2
Apical 302



710/3
Apical 303



710/4
Apical 304



710/5
12 A

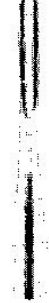

710/6
34 S Seldin



710/7
34 Seldin



710/8



710/9
Flohr



710/10
Flohr



710/11
Flohr



710/12
3 Seldin



710/13



710/14
3 A Cryer



710/15
2 Seldin



710/16
12 Cryer



710/17
5 Seldin



710/18
Crane
Pick



710/19



Wurzelheber Root elevators
Elévateurs à racines
Elevadores para raíces

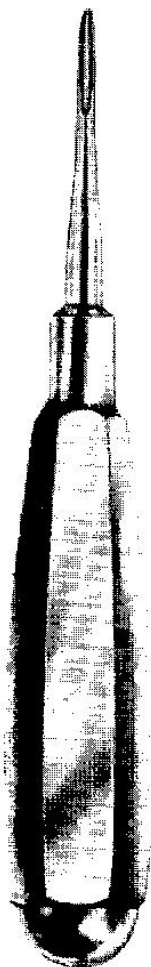

710/20
Flohr

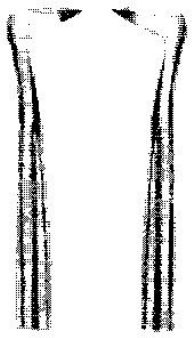

710/21 710/22
1 L Seldin 1 R Seldin

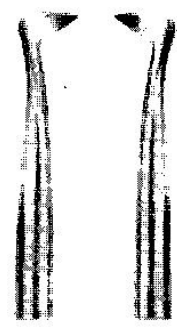

710/23 710/24
4 L Seldin 4 R Seldin

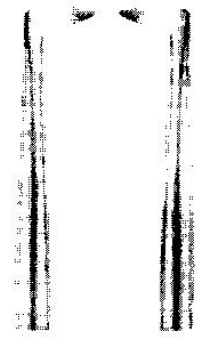

710/25 710/26

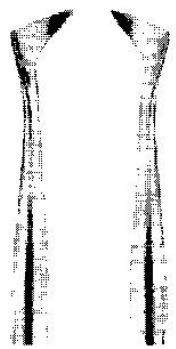

710/27 710/28
27 Cryer 28 Cryer

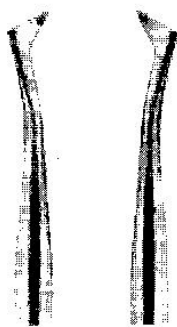

710/27 S 710/28 S
27 S Cryer 28 S Cryer

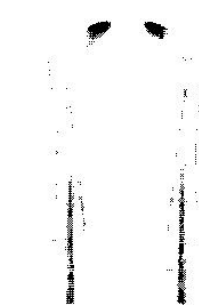

710/29 710/30
(344) (345)

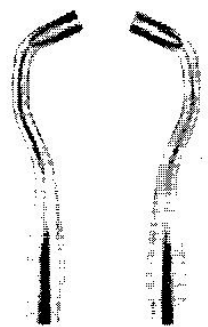

710/31 710/32

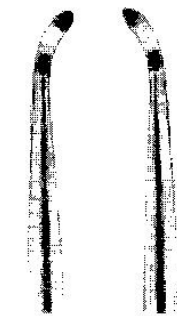

710/33 710/34
Miller 1 Miller 2

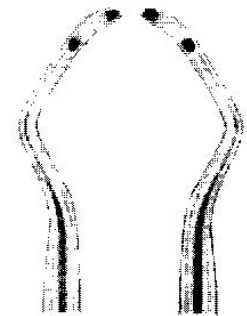

710/35 710/36
Miller 3 Miller 4



Wurzelheber Root elevators
Elévateurs à racines
Elevadores para raíces

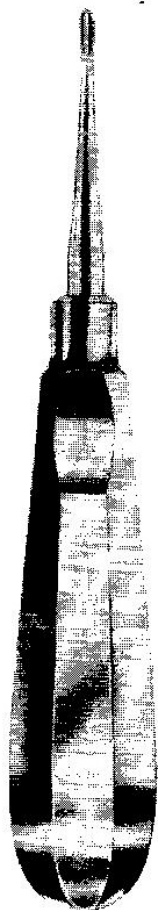

720/1
Apical 301

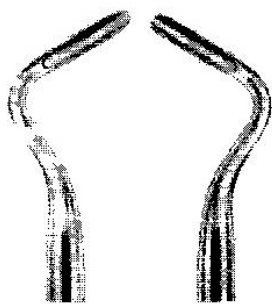

720/2
Apical 302

720/3
Apical 303



720/4
Apical 304



720/5
12 A



720/6
34 S Seldin



720/7
34 Seldin



720/8



720/9
Flohr



720/10
Flohr



720/11
Flohr



720/12
3 Seldin



720/13



720/14
3 A Cryer



720/15
2 Seldin



720/16
12 Cryer



720/17
5 Seldin



720/18
Crane
Pick



720/19



Wurzelheber

Root elevators
Elévateurs à racines
Elevadores para raíces

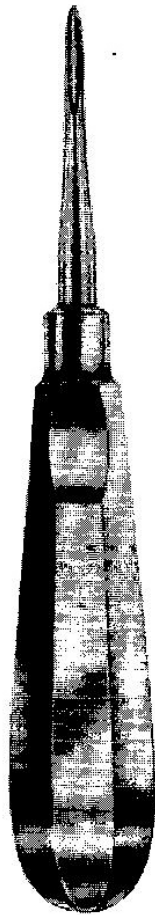

720/20
Flohr

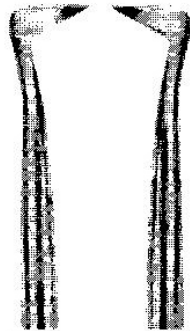

720/21 1 L Seldin
720/22 1 R Seldin



720/23 4 L Seldin
720/24 4 R Seldin

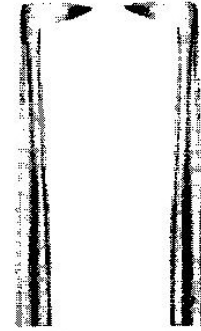

720/25
720/26



720/27 27 Cryer
720/28 28 Cryer

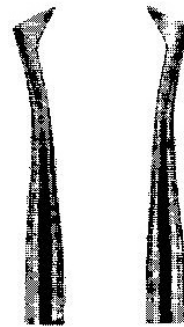

720/27 S 27 S Cryer
720/28 S 28 S Cryer

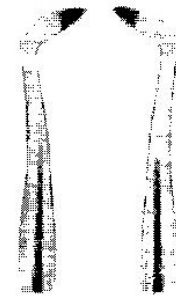

720/29 (344)
720/30 (345)

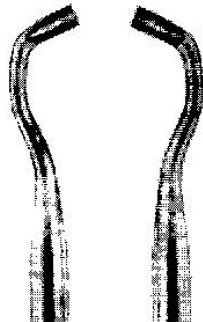

720/31
720/32



720/33 Miller 1
720/34 Miller 2

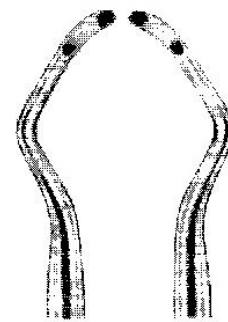

720/35 Miller 3
720/36 Miller 4



Wurzelheber Root elevators
Élévateurs à racines
Elevadores para raíces

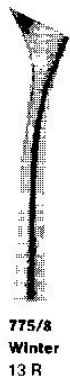
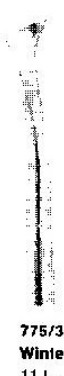
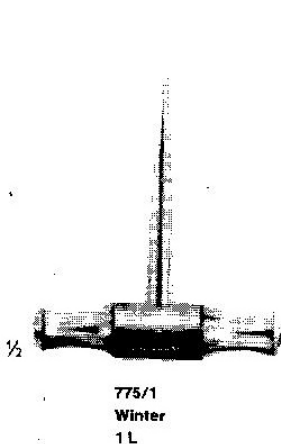



Wurzelheber Root elevators
Élévateurs à racines
Elevadores para raíces

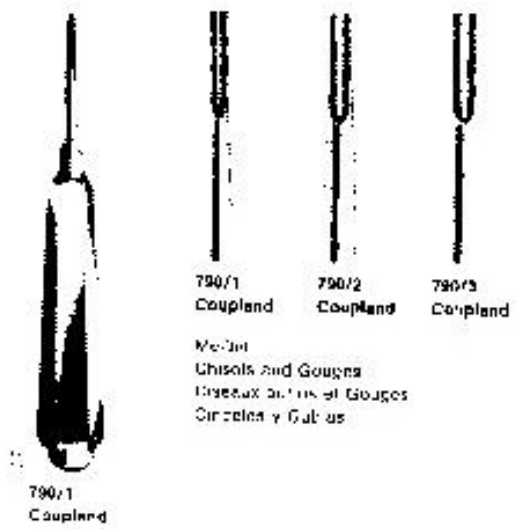
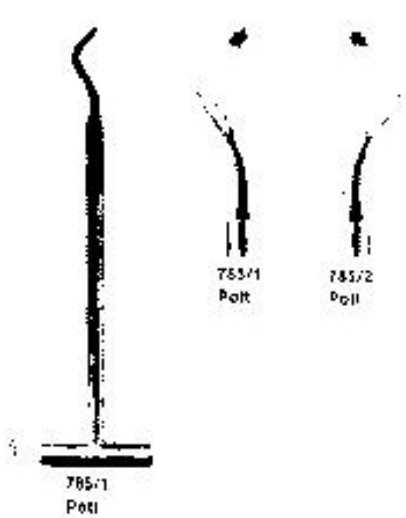
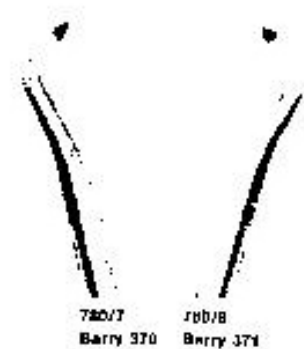
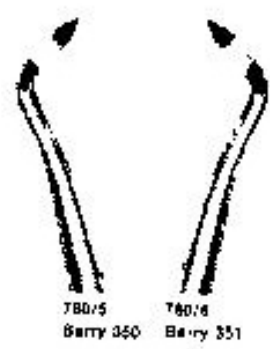
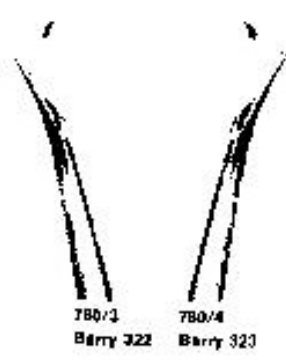
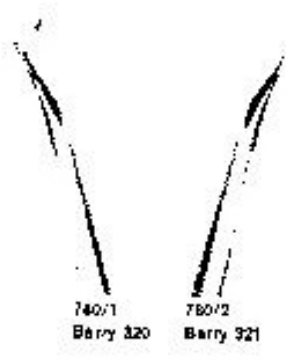
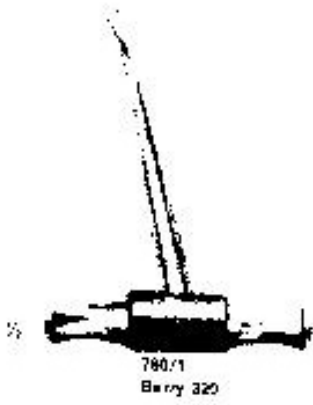

Hohlmeißelzangen Bone Rongeurs
Pinces-gouges
Pinzas-gubias

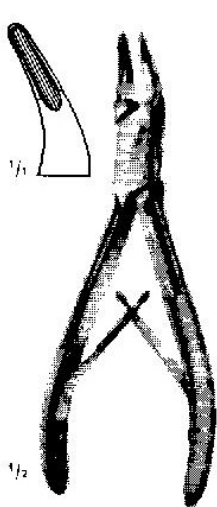

820/1
Blumenthal

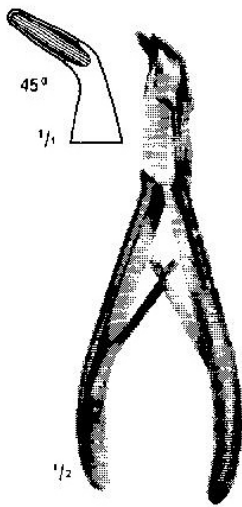

820/2
Blumenthal

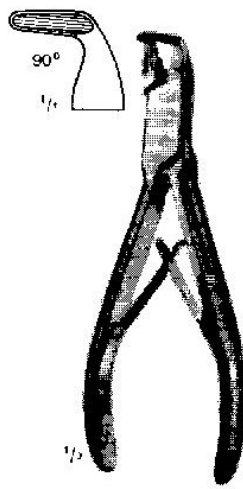

820/3
Blumenthal

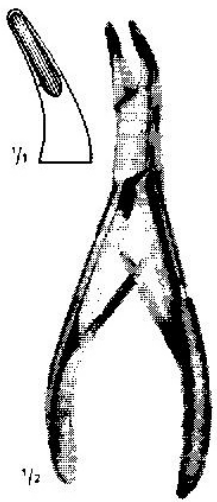

820/4
Blumenthal-S

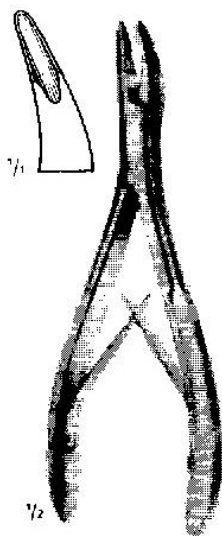

820/5
Blumenthal
18 cm

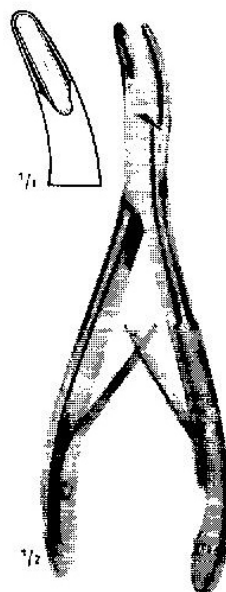

820/6
Harlmann

Hohlmeißelzangen

Bone Rongeurs
Pincés-gouges
Pinzas-gubias

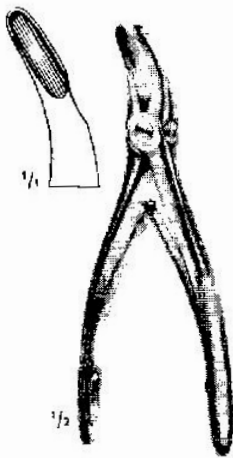

820/7
Universal

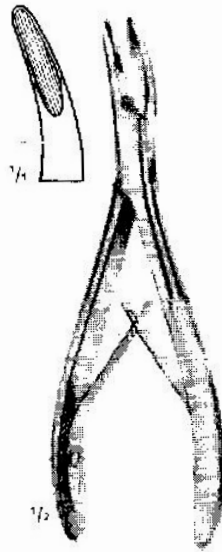

820/8
Mead 1 A

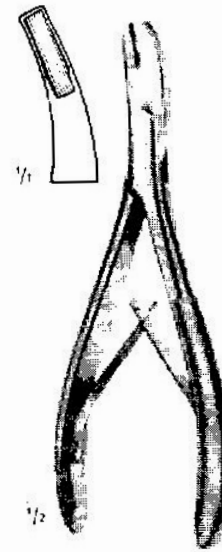

820/9
Mead 2 A

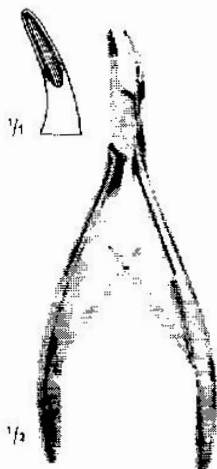

820/10
Friedman

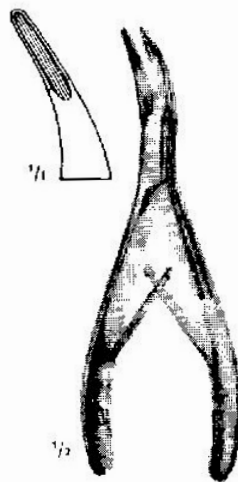

820/11
Luer

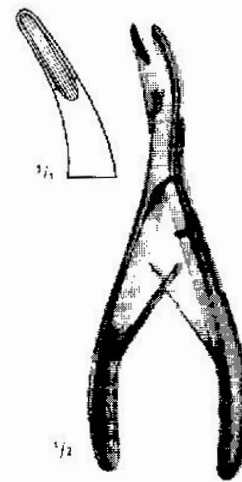

820/12
Luer

Hohlmeißelzangen	Bone Rongeurs	Bone Cutting Forceps
Knochensplitterzangen	Pinces-gouges	Pinces coupantes à os
	Pinzas-gubias	Cizallas

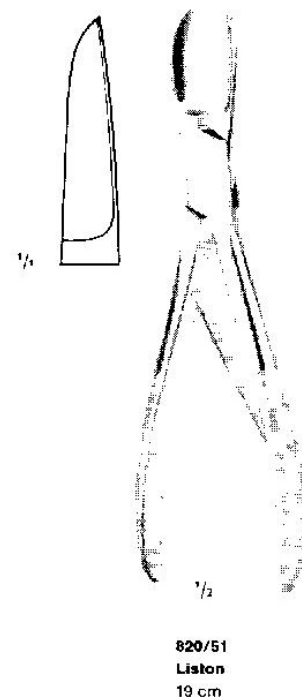
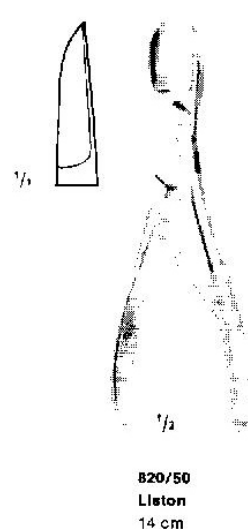
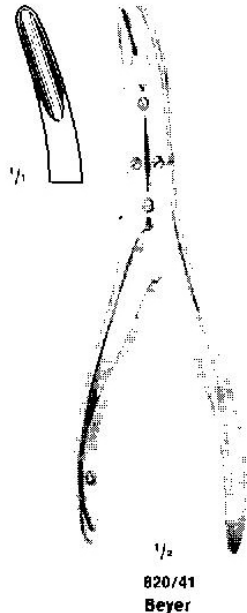
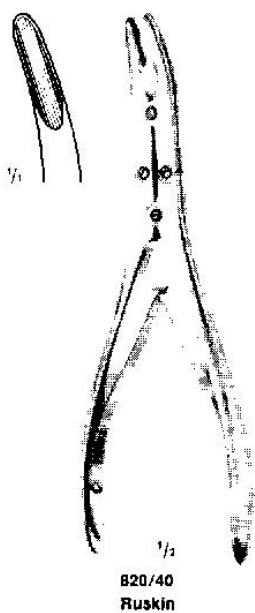

Flachmeißel
Hohlmeißel

Chisels and Gouges
Burins et gouges
Cinceles y gubias

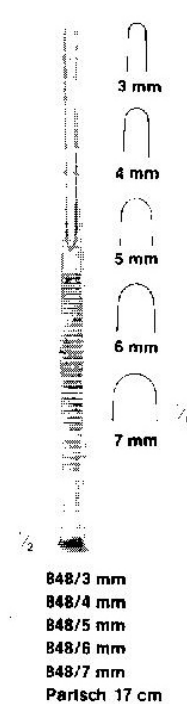
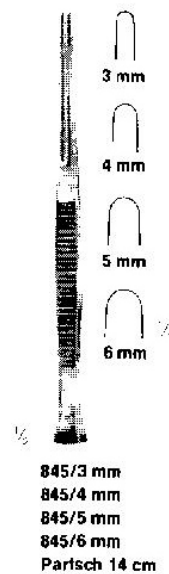
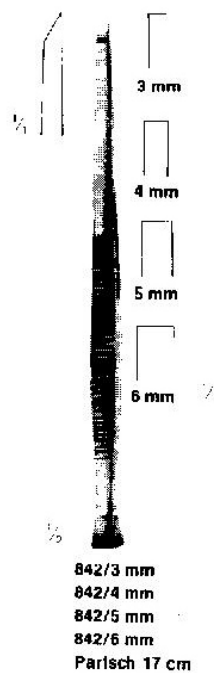
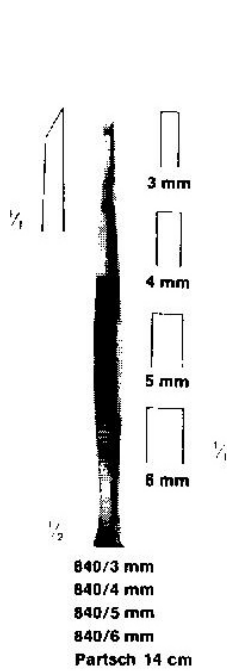
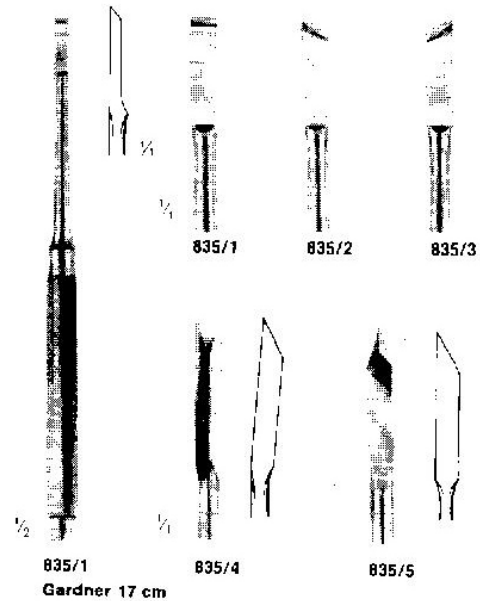
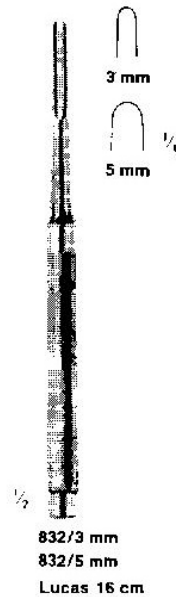
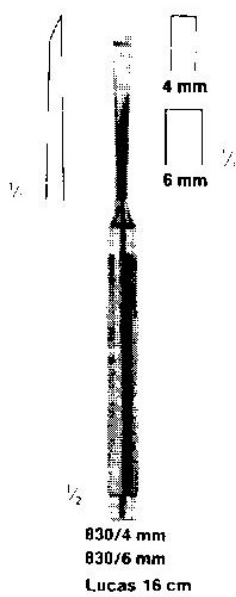

Knochenfeilen

Bone Files

Limes à os

Limas para huesos

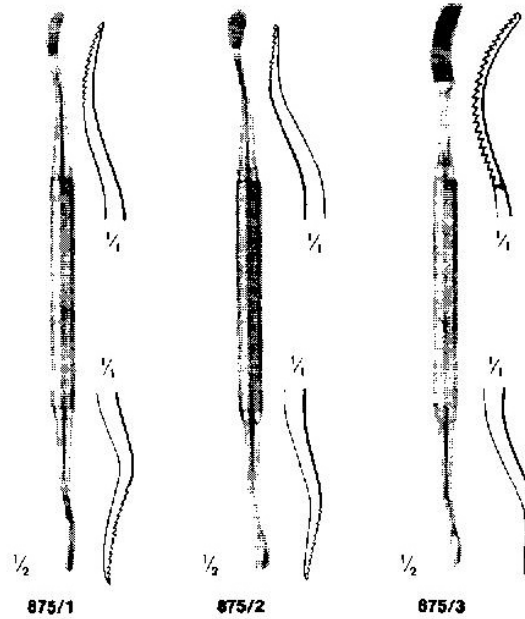
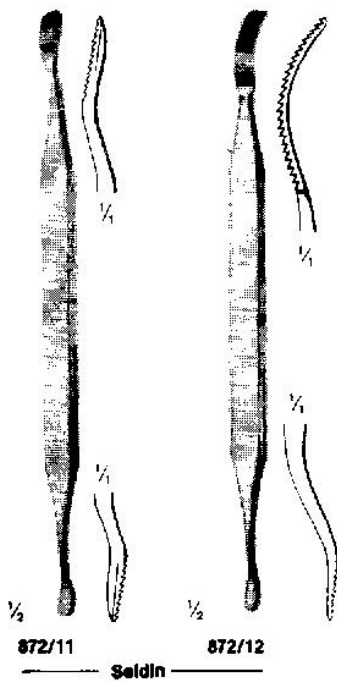
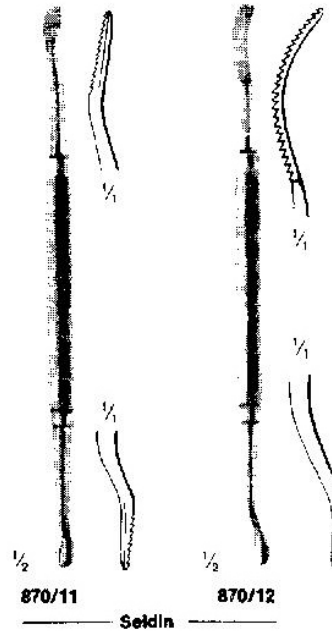
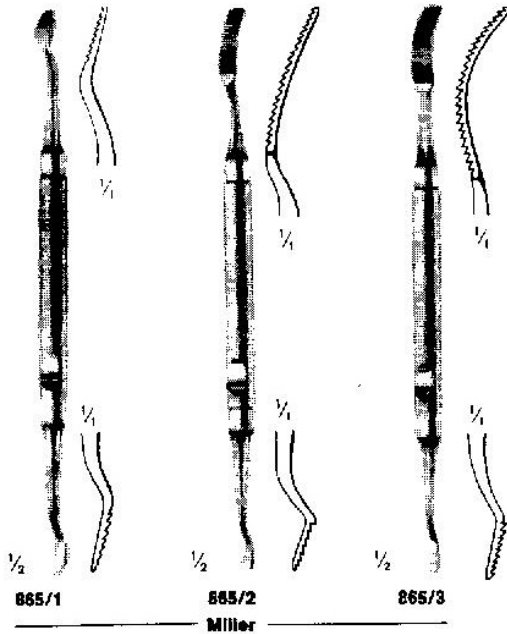

**Raspatorien
Elevatorien**

Raspatories, Periosteal Elevators
Rugines, Elévateurs pour le périoste
Legras, Elevadores del periostio

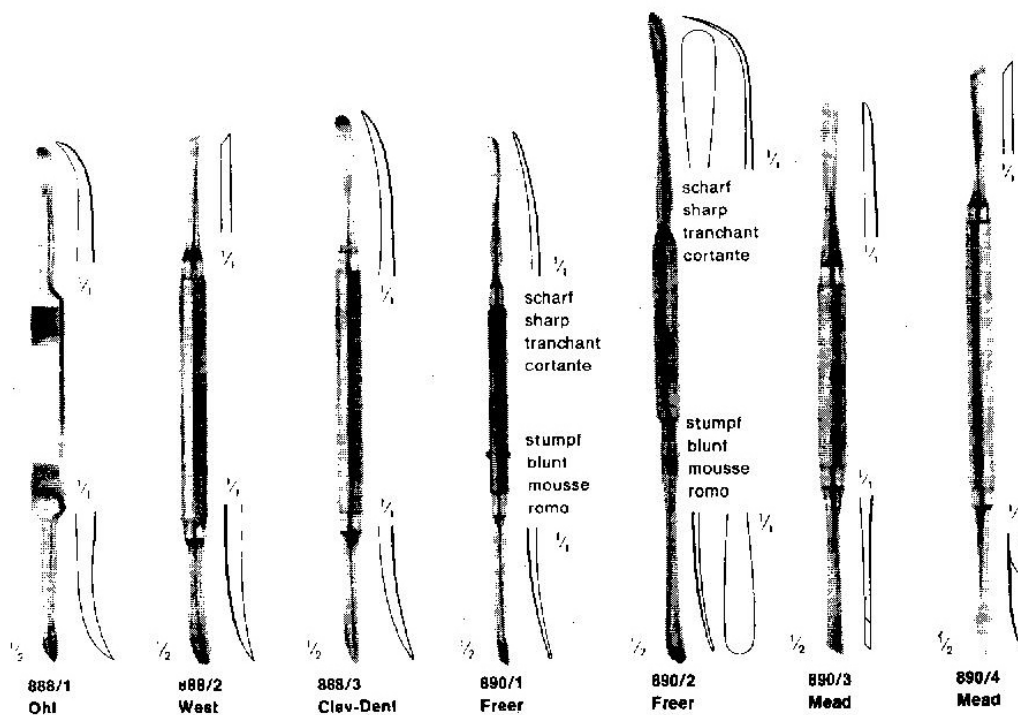
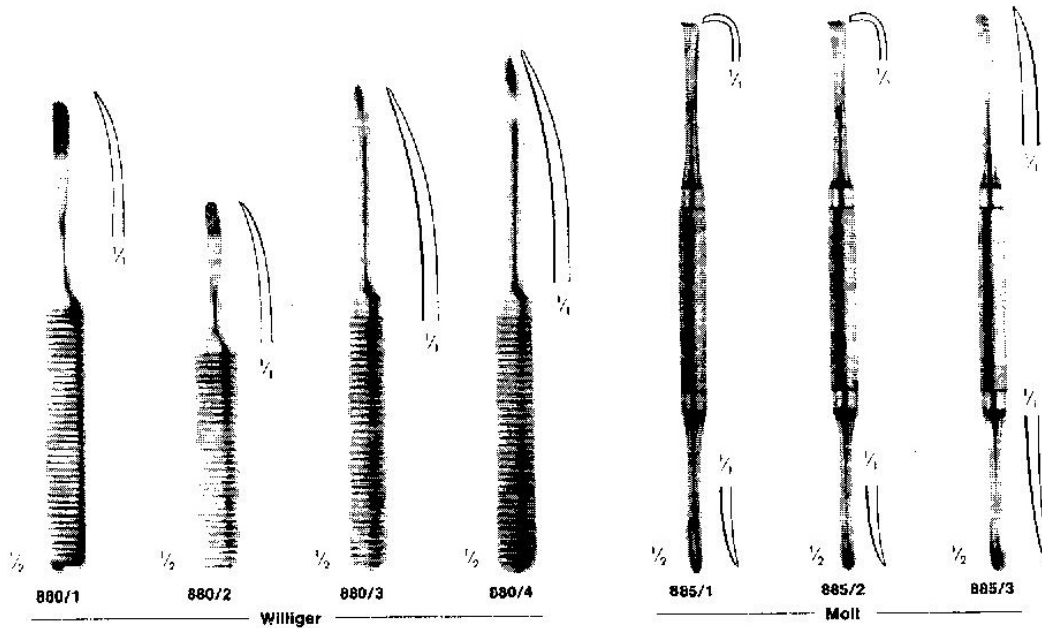

Scharfe Löffel Bone Currettes
Currettes tranchantes
Curetas cortantes

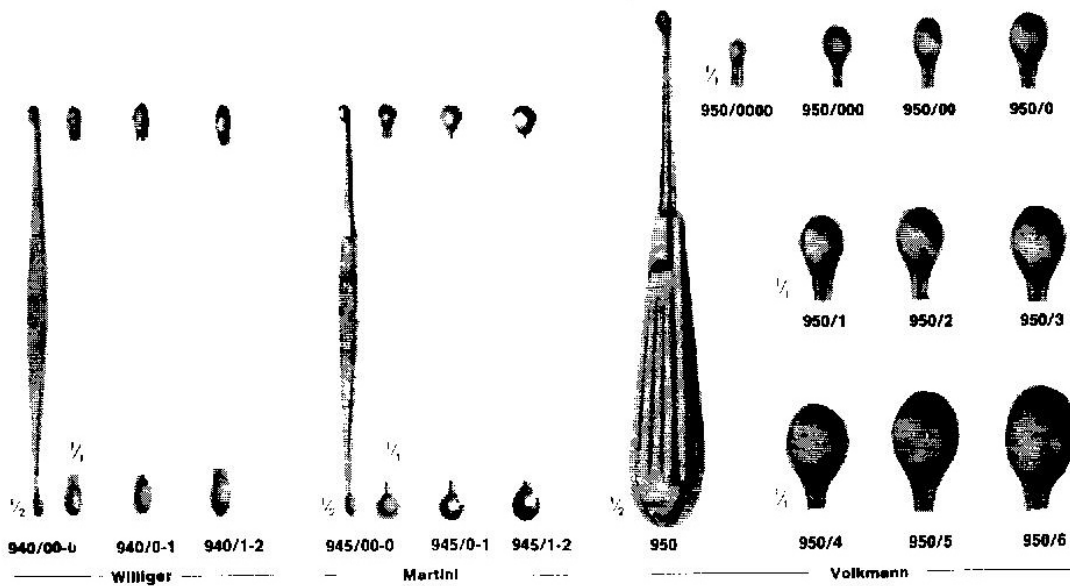
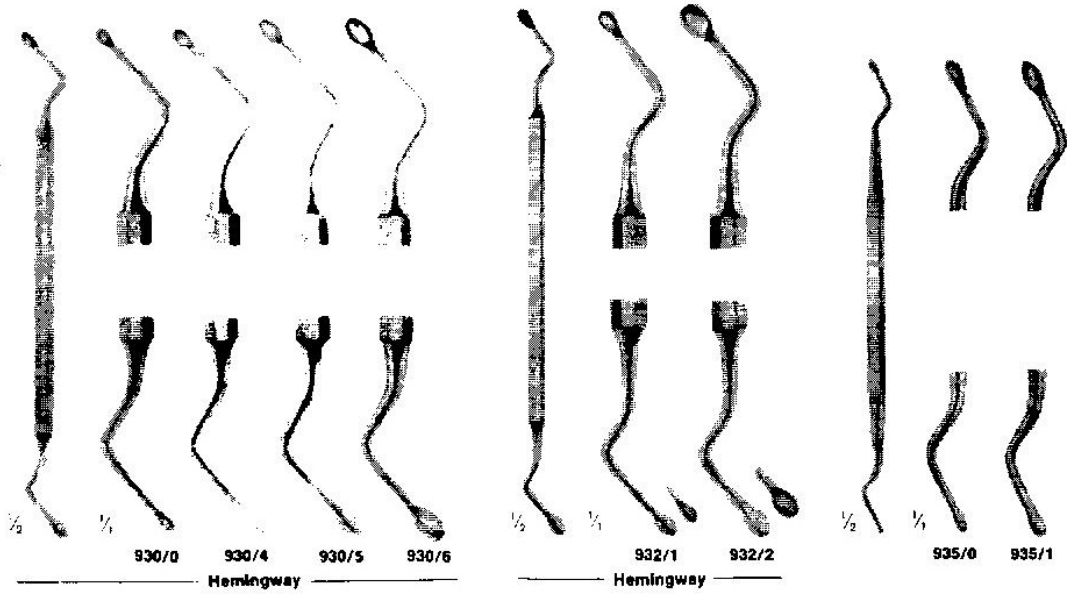

Nadelhalter

Needle Holders
Porte-aiguilles
Porta-agujas

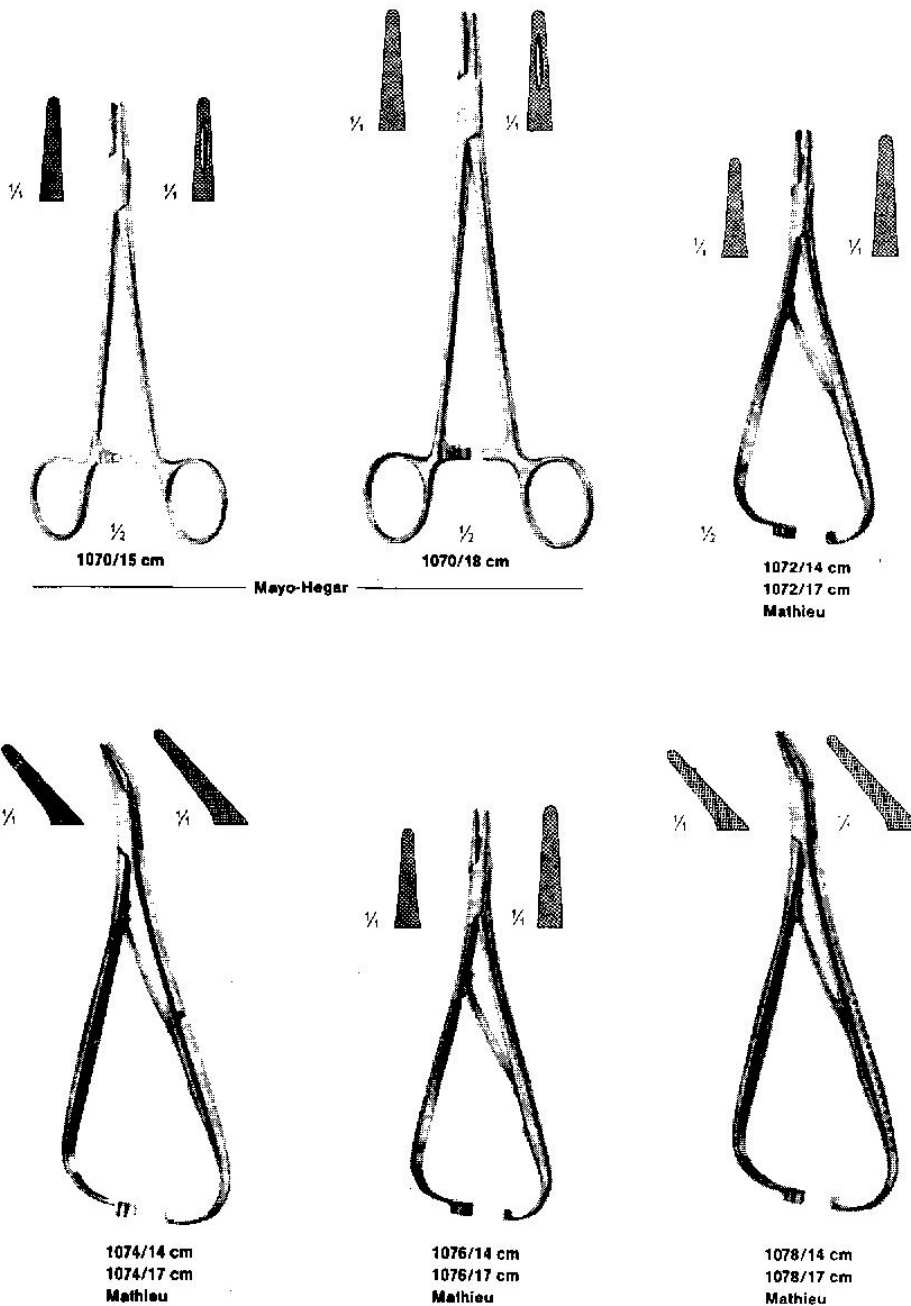

**Wundspreizer
Mundsperrer**

Retractors – Mouth Gags
Ecarteurs – Ouvre-bouches
Separadores – Abre-bocas

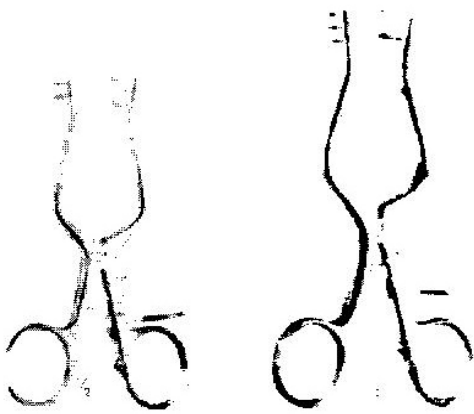

1100/1 10,5 cm 1100/2 13 cm
scharf – sharp – pointes – agudos

Weltaner

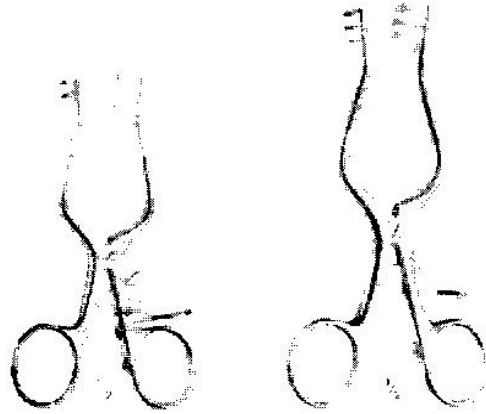

1102/1 10,5 cm 1102/2 13 cm
stumpf – blunt – mousses – romos

Weltaner



1105/11 cm
1105/13 cm
1105/15 cm
Whitehead

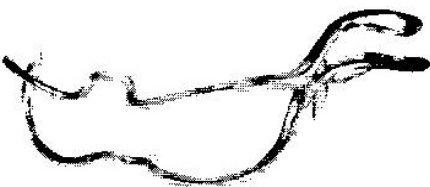

1110/11 cm
1110/13 cm
1110/15 cm
Jemings

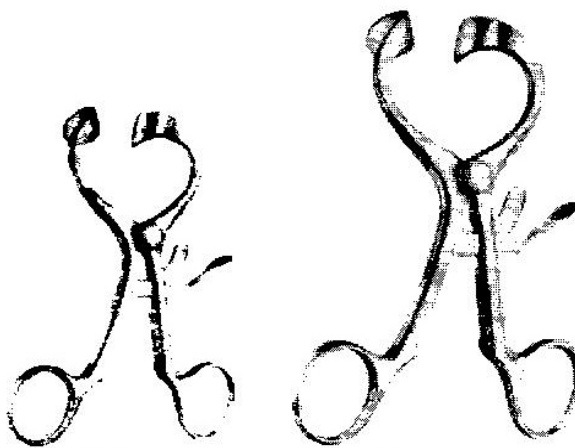

1115/11 cm

1115/14 cm

Moll

Zahnfleischscheren Gum Scissors
Ciseaux à gencives
Tijeras para encías

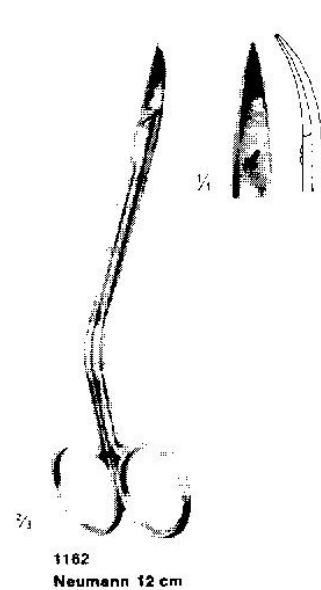
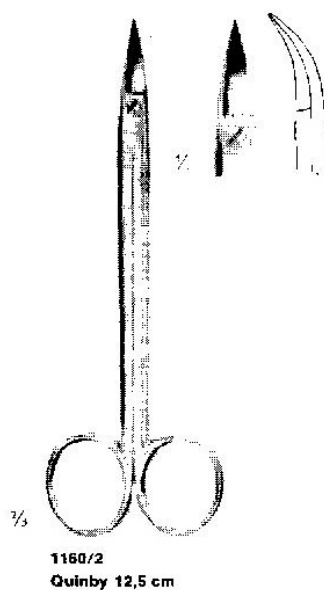
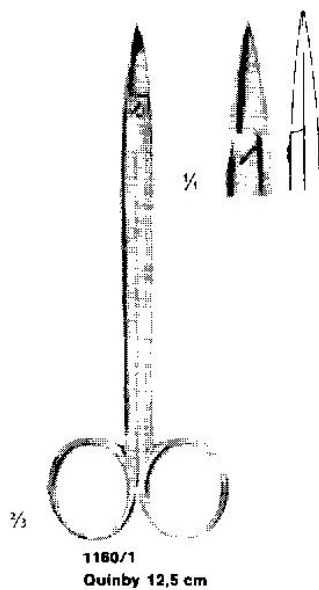
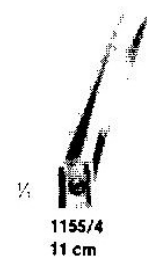
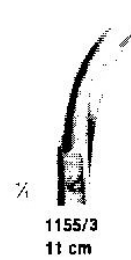
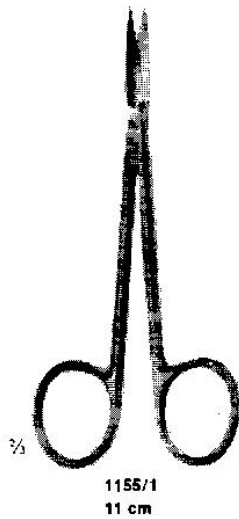



Zahnreiniger Scalers
Instruments à détartrer
Limpiadores de sarro



1200/1



1200/2



1200/3



1200/4



1200/6



1200/7



1200/32

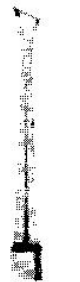

1200/33



1200/34



1200/35
33 1/2



1200/36
34 1/2

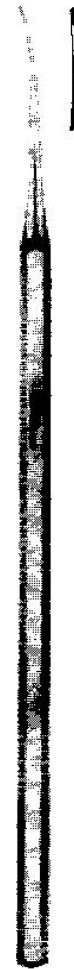

1205/1
Darby-Perry



1205/4
Darby-Perry



1205/5



1205/6

- Darby-Perry -



1205/11
Darby-Perry



Zahnreiniger Scalers
Instruments à détartrer
Limpiadores de sarro

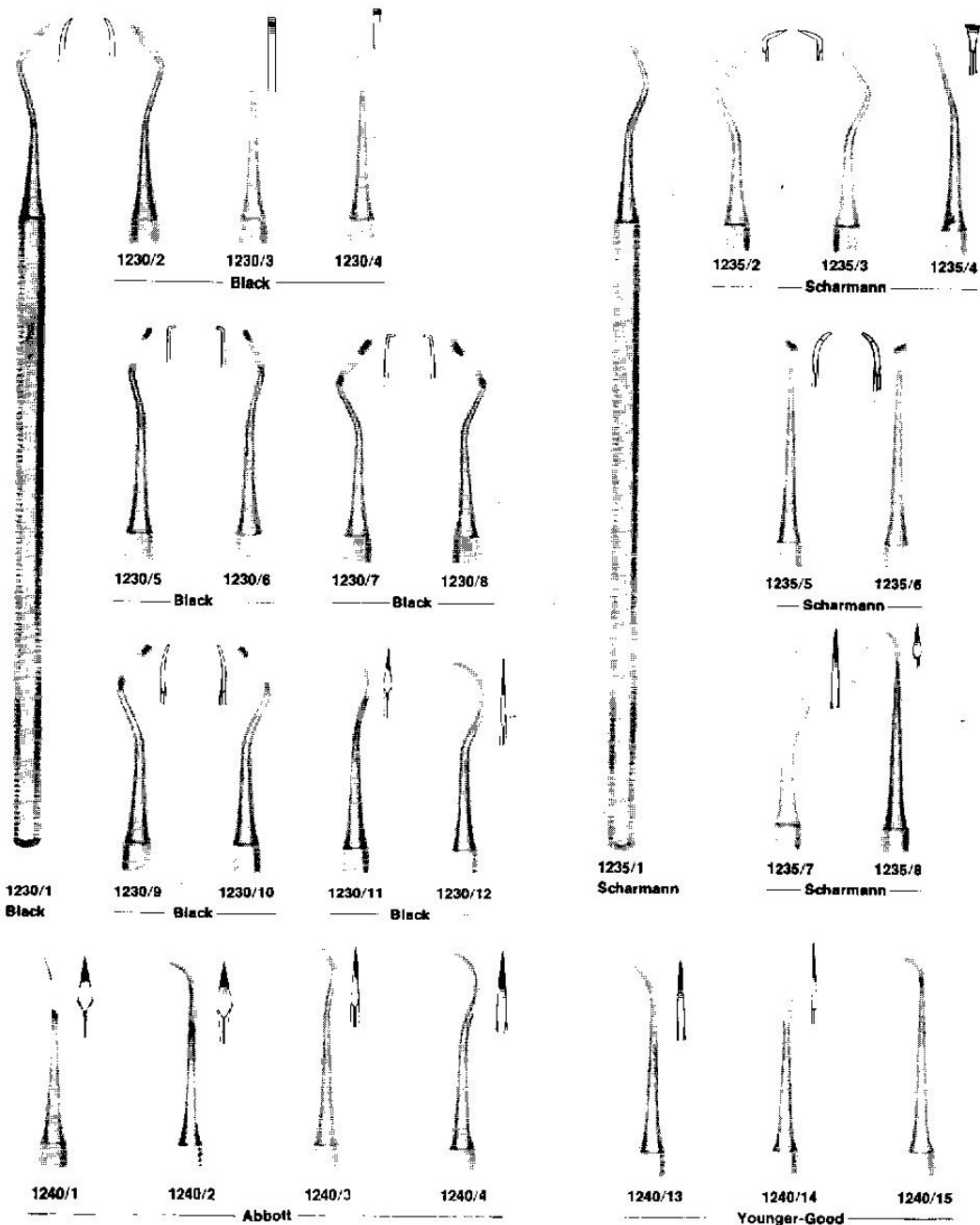



Excavatoren Excavators
Excavateurs
Excavadores

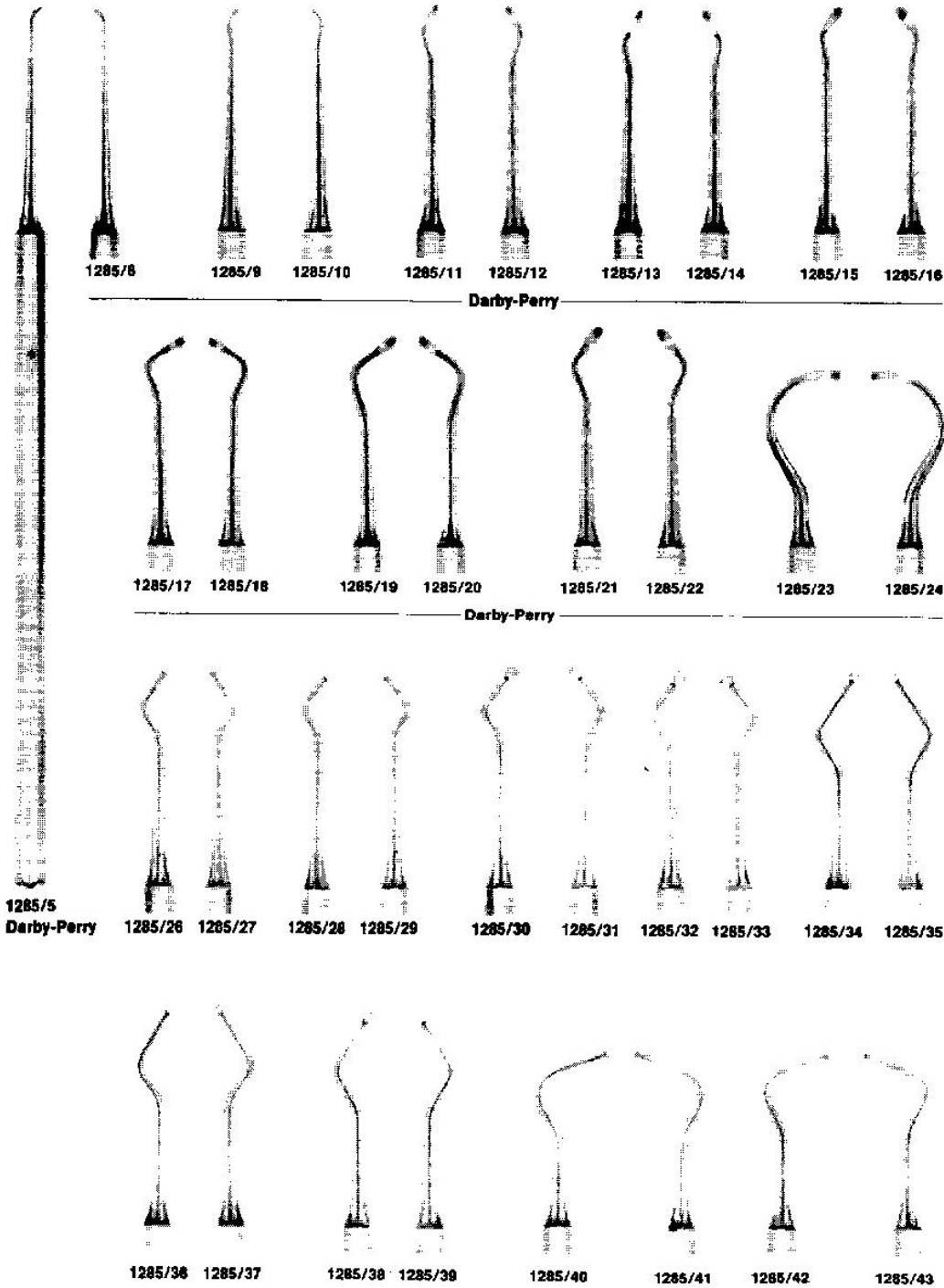



Excavatoren
Excavators
Excavateurs
Excavadores

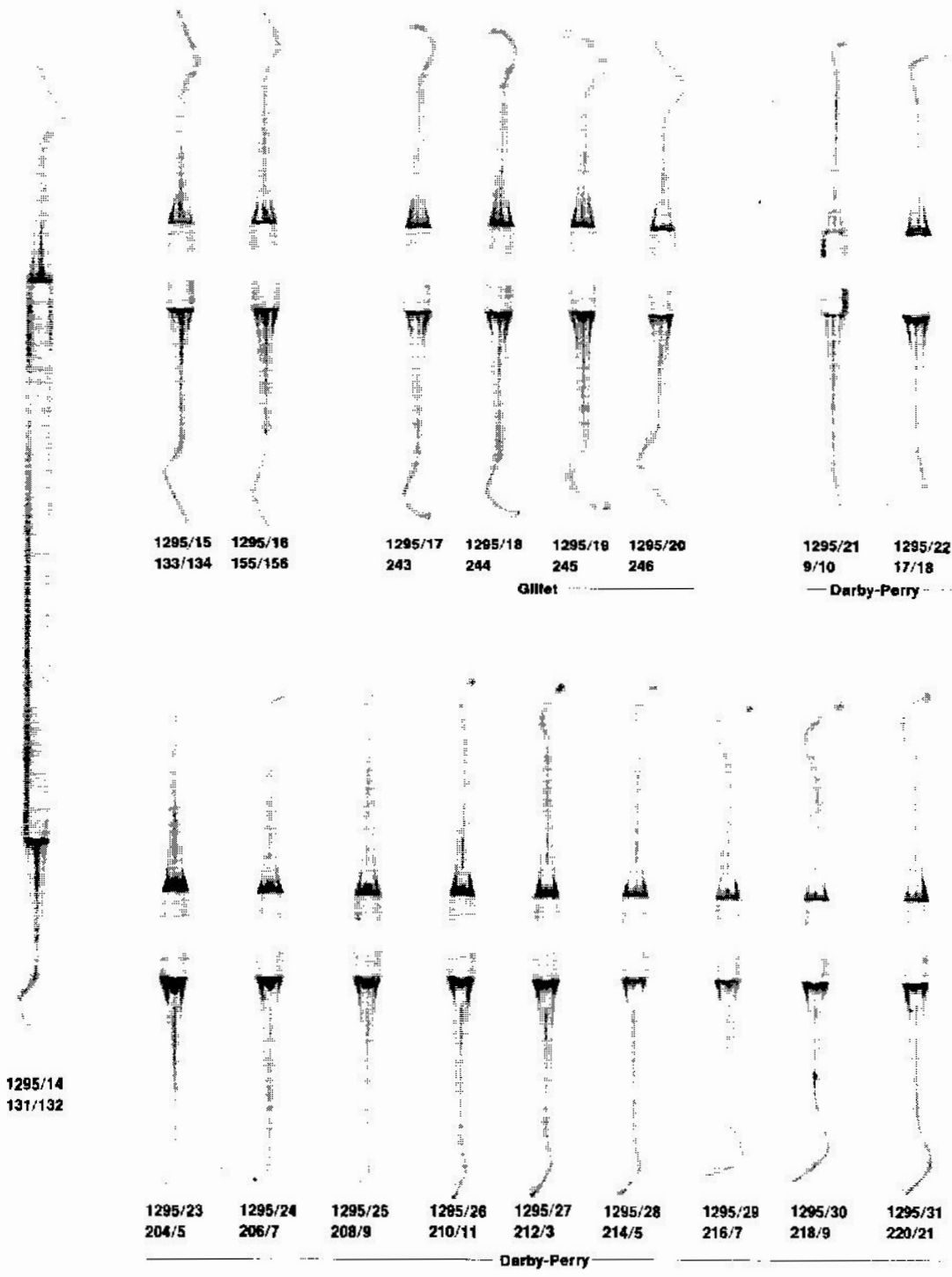



Schneidende Instrumente Cutting Instruments
Instruments tranchants
Instrumentos cortantes

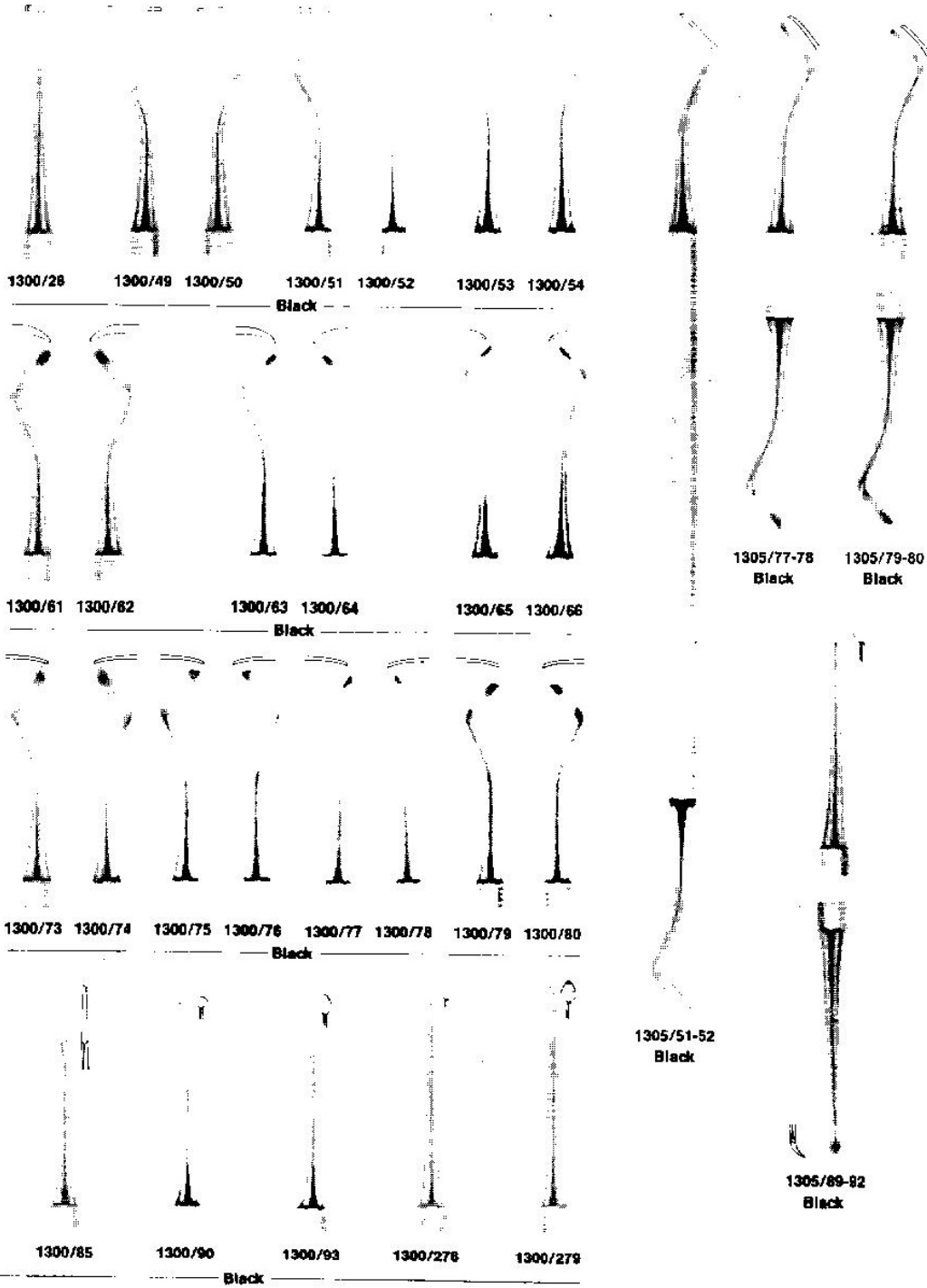



Zahnsonden Probes and Explorers
Sondes et Explorateurs
Sondas y Exploradores

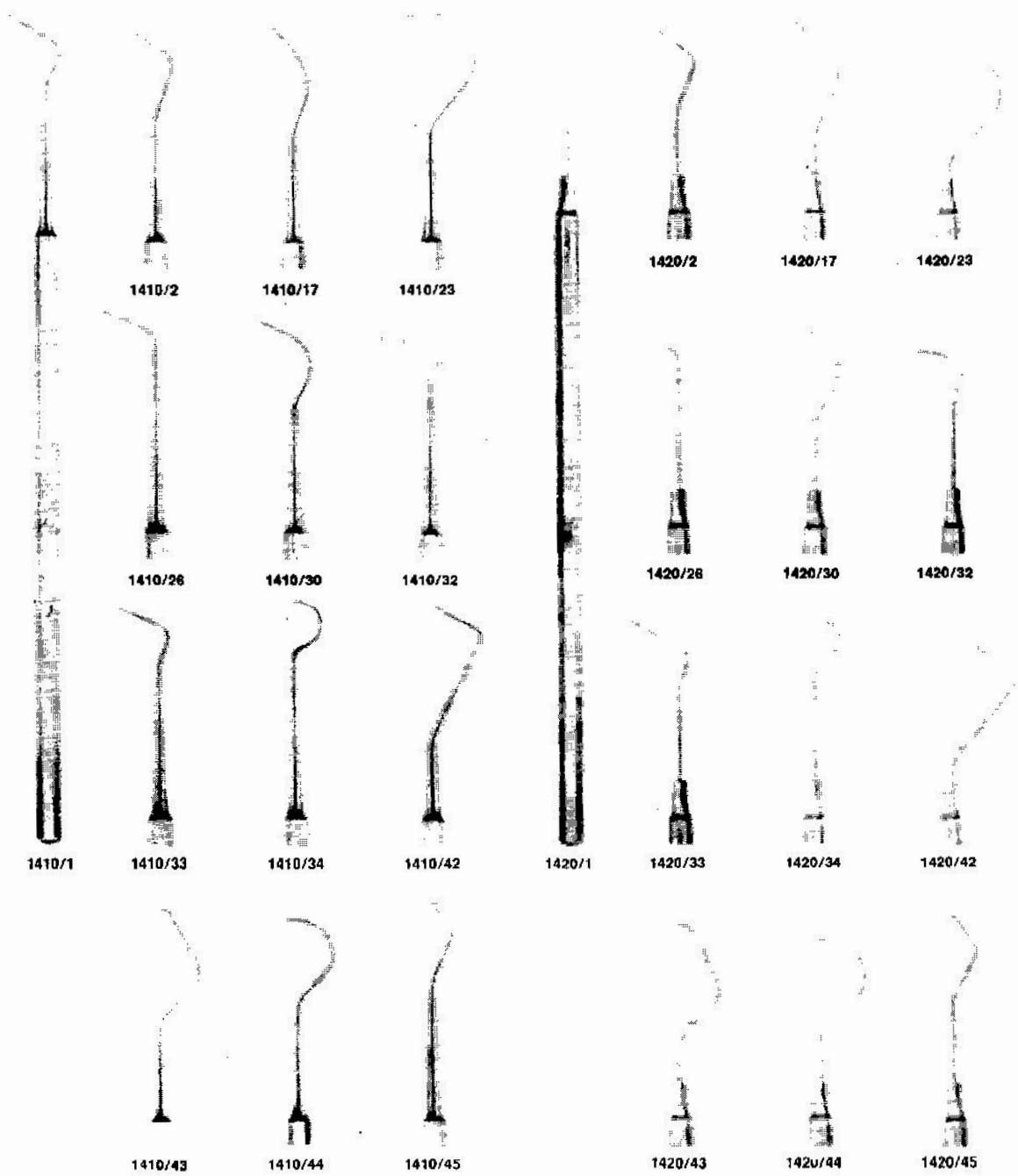



Zahnsonden Probes and Explorers
Sondes et Explorateurs
Sondas y Exploradores

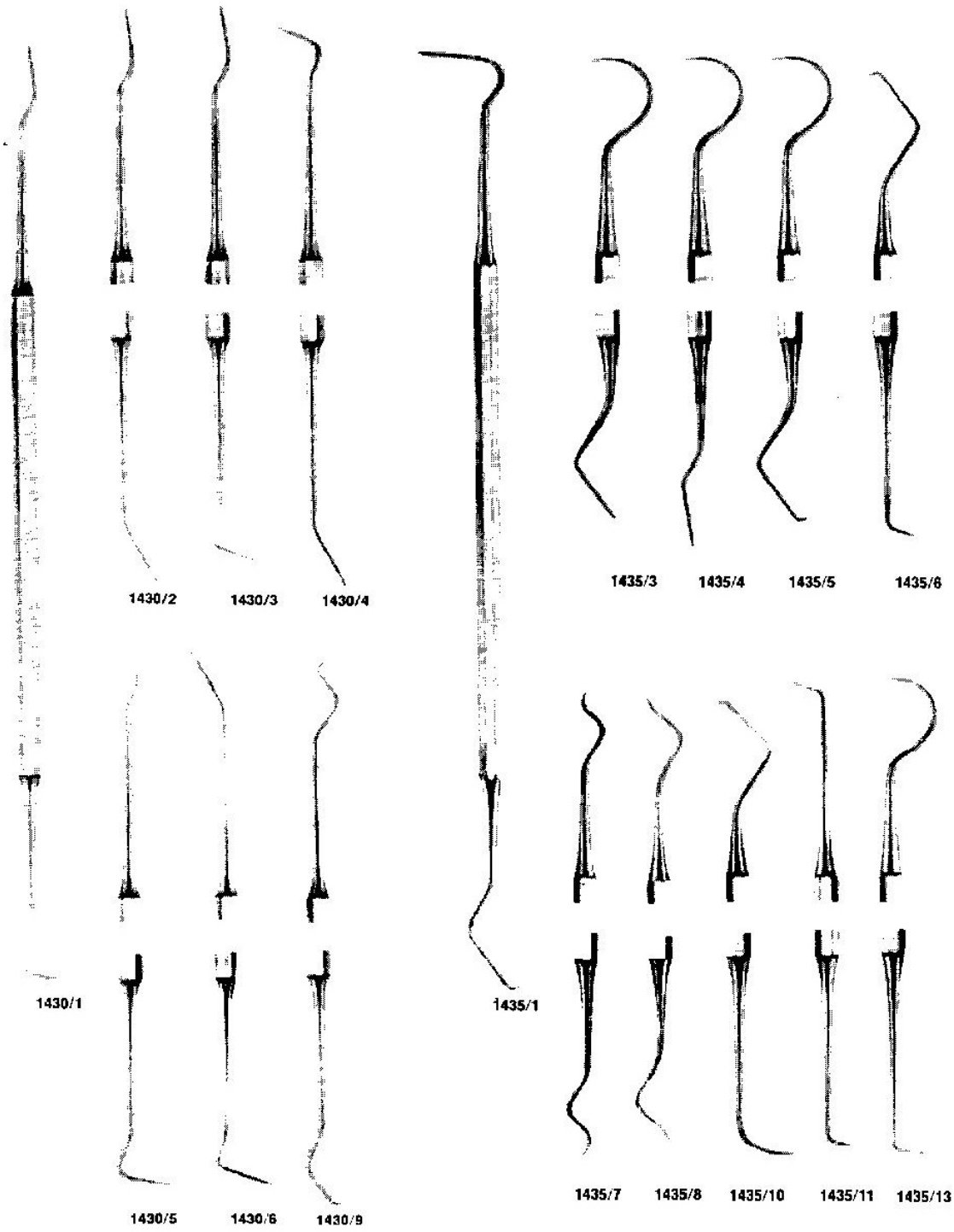



Zementspateln Cement Spatulas
Spatules à ciment
Espátulas para cemento

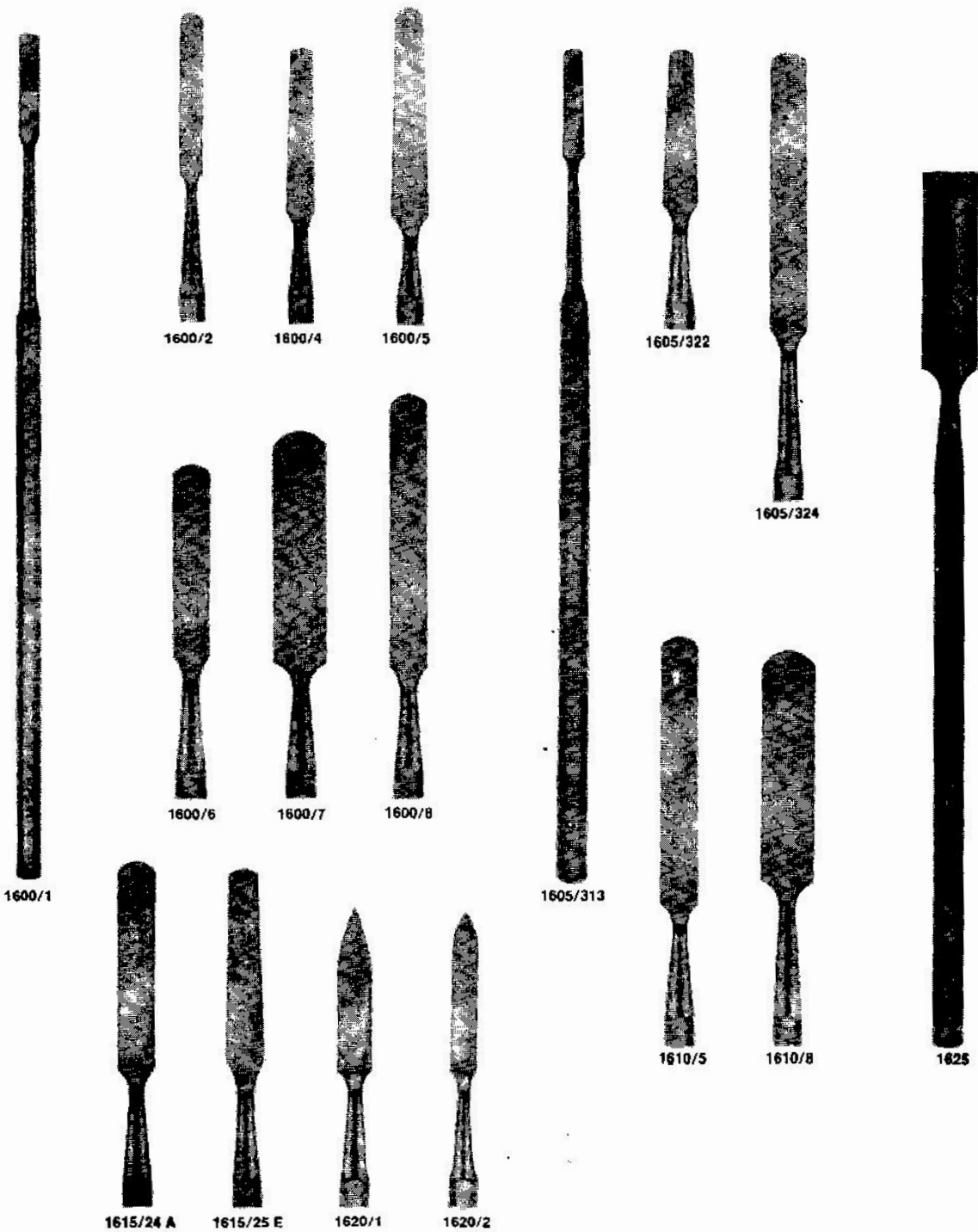

Füllungsinstrumente Filling instruments
 Instruments pour plombage
 Instrumentos para obturaciones

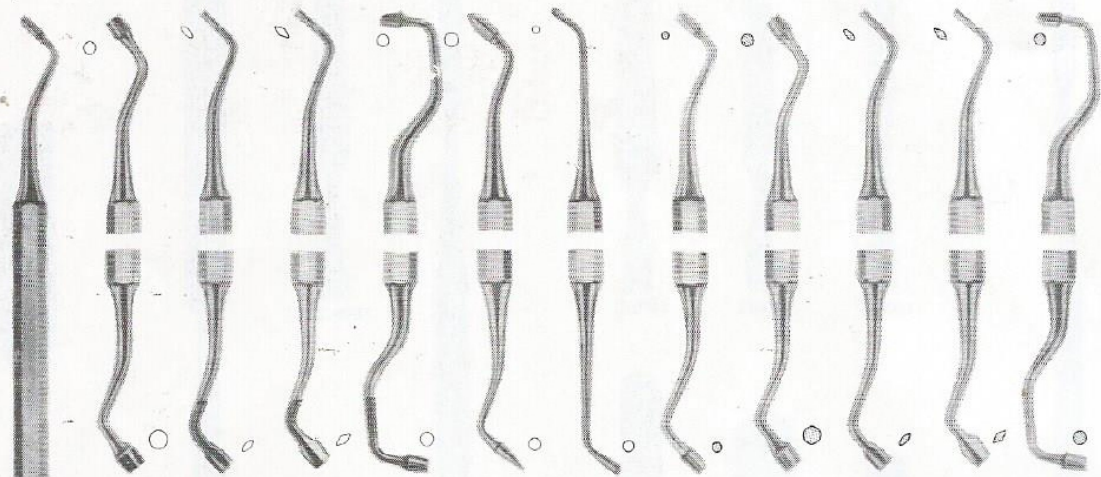

1760/2 1760/3 1760/4 1760/5 1760/6 1760/7 1762/1 1762/2 1762/3 1762/4 1762/5
 ————— Hollenback ————— Hollenback

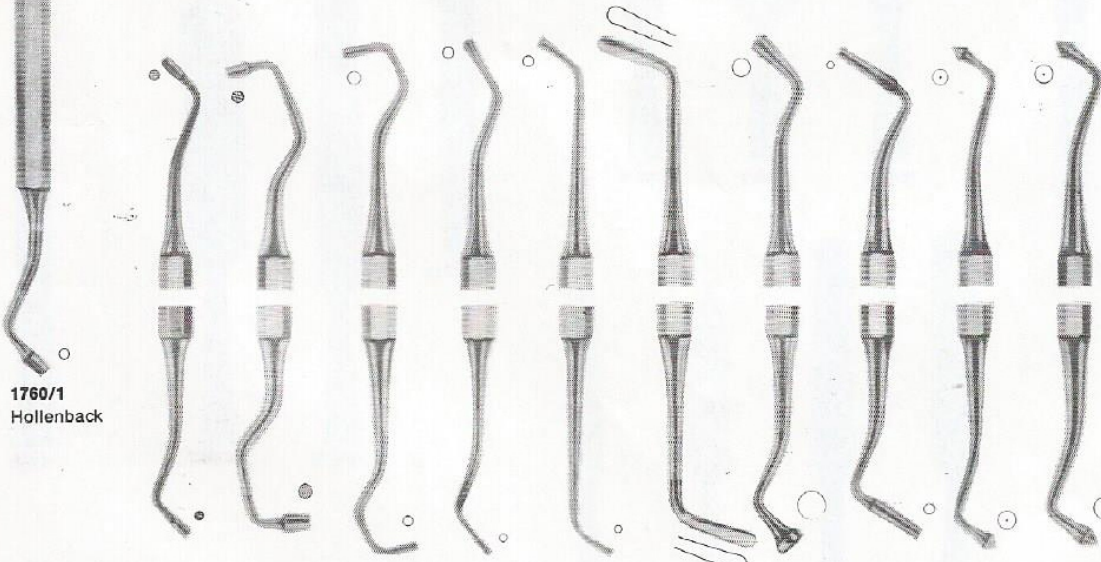

1760/1
Hollenback

1770/1-0 1770/12 1780/1 1780/2 1780/3 1780/5 1780/7 1790/2 1790/21 1790/21B
 ————— Ladmore ————— Mortenson

Füllungsinstrumente

Filling instruments
Instruments pour plombage
Instrumentos para obturaciones

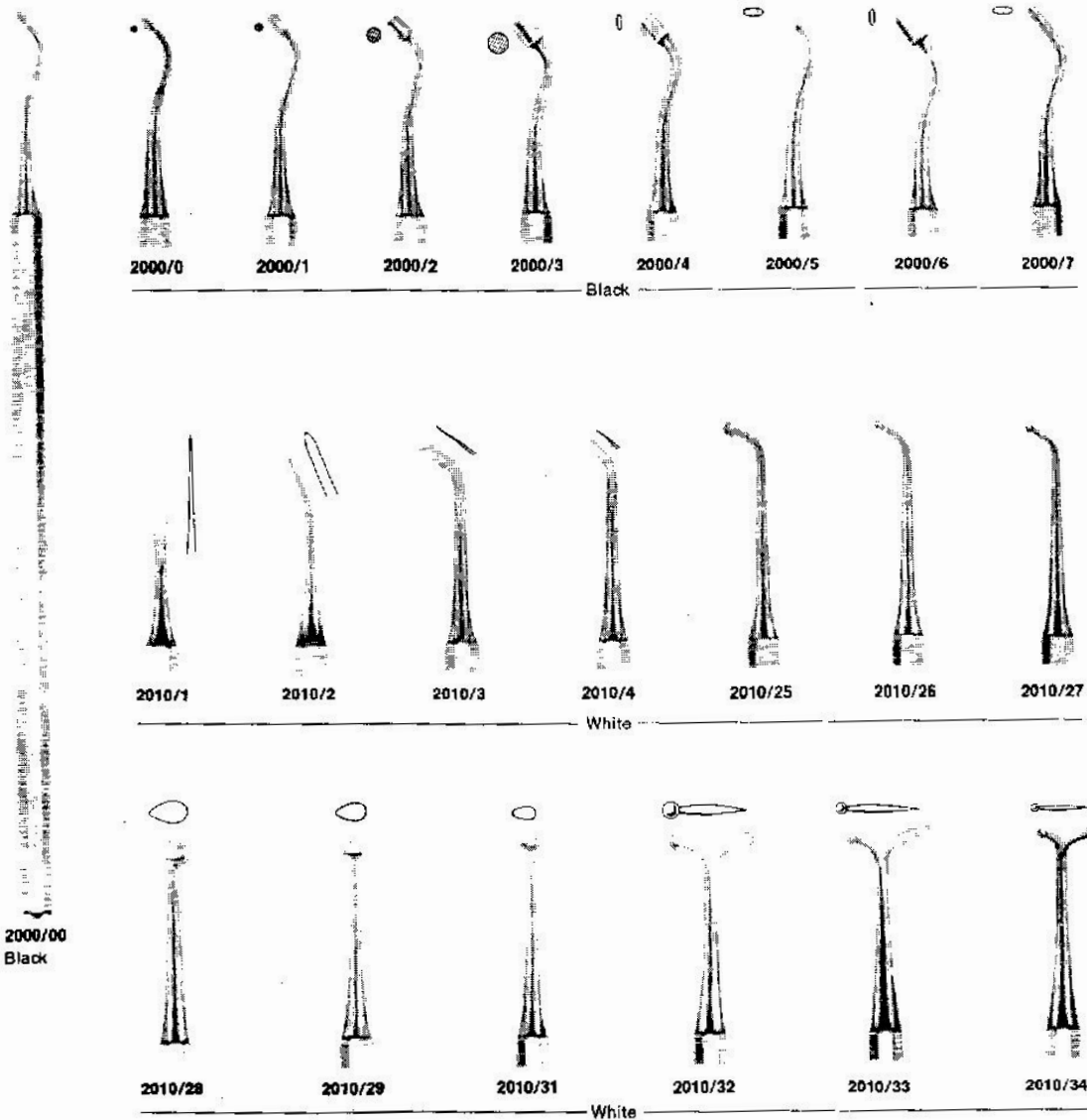

Polierinstrumente – Burnishers – Brunissoirs – Bruñidores

**Wachs- und
Modellierinstrumente**

Wax and Modelling Carvers
Instruments à cire et à modeler
Talladores para cera y para modelar

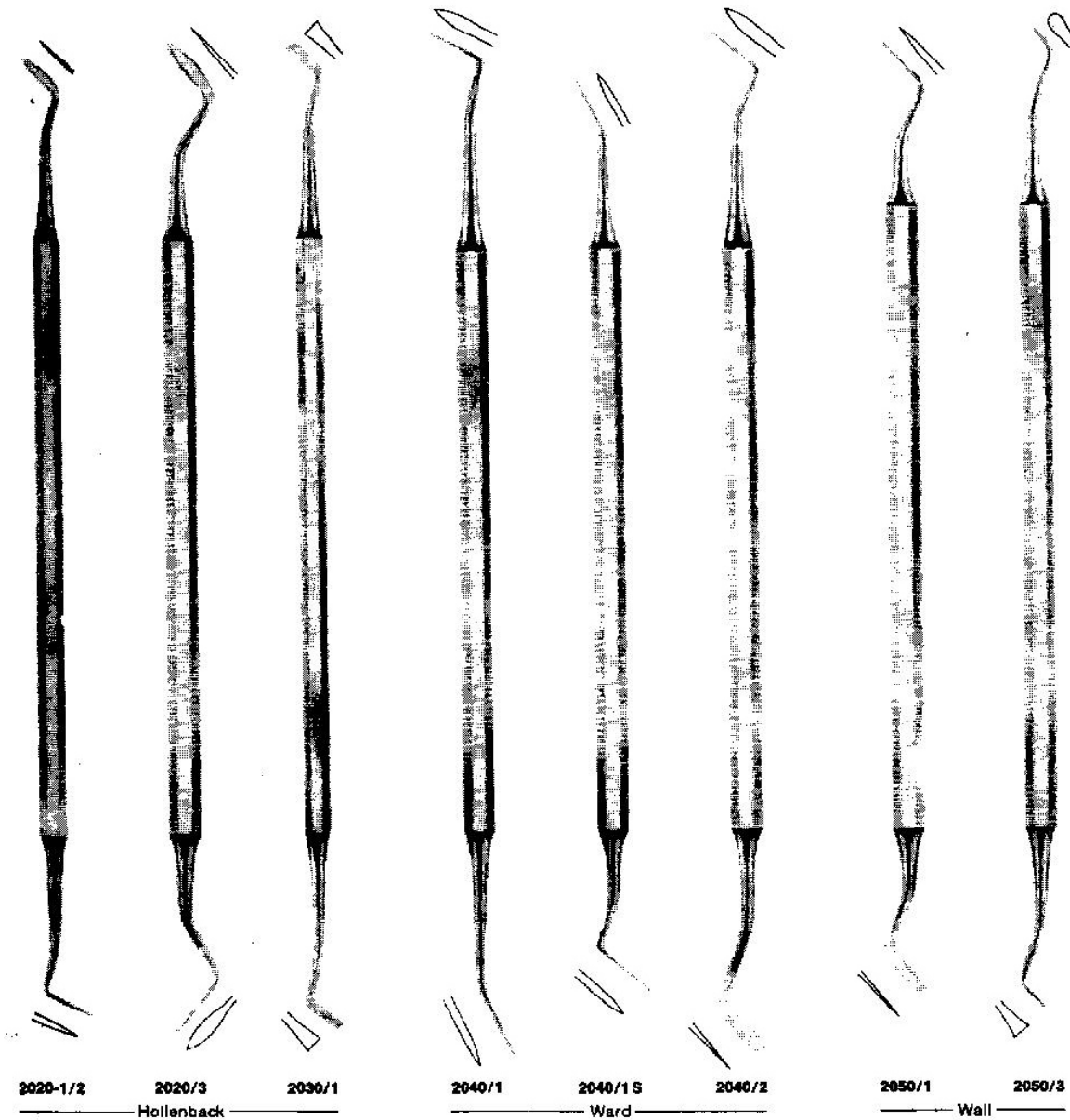



Wachs- und Modellierinstrumente	Wax and Modelling Carvers Instruments à cire et à modeler Talladores para cera y para modelar
--	---



2100/1
Le Cron



2100/2
Le Cron



2110
Roach

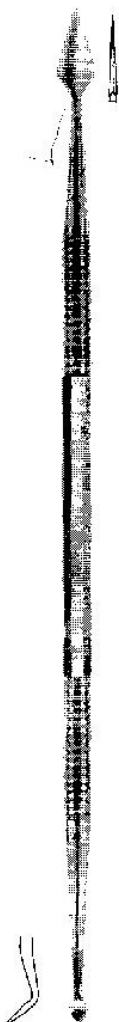

2120
Vehe



2130
Reeves



2140
Fliege

Wachs- und Modellierinstrumente
Wax and Modelling Carvers
Instruments à cire et à modeler
Talladores para cera y para modelar



2150
Gritman 31



2160
Beale



2170
Beale 7 A

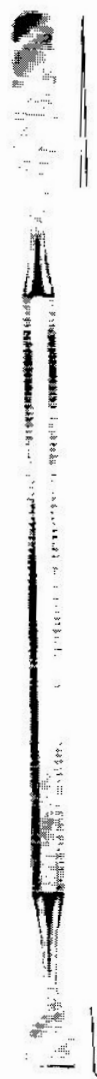

2180
Weston



2190/2



2190/5



Wachsmesser Wax Knives, Silicate Spatulas
Silikatspatel Couteaux à cire, Spatules à silicate
Cuchillos para cera, Espátulas para silicato

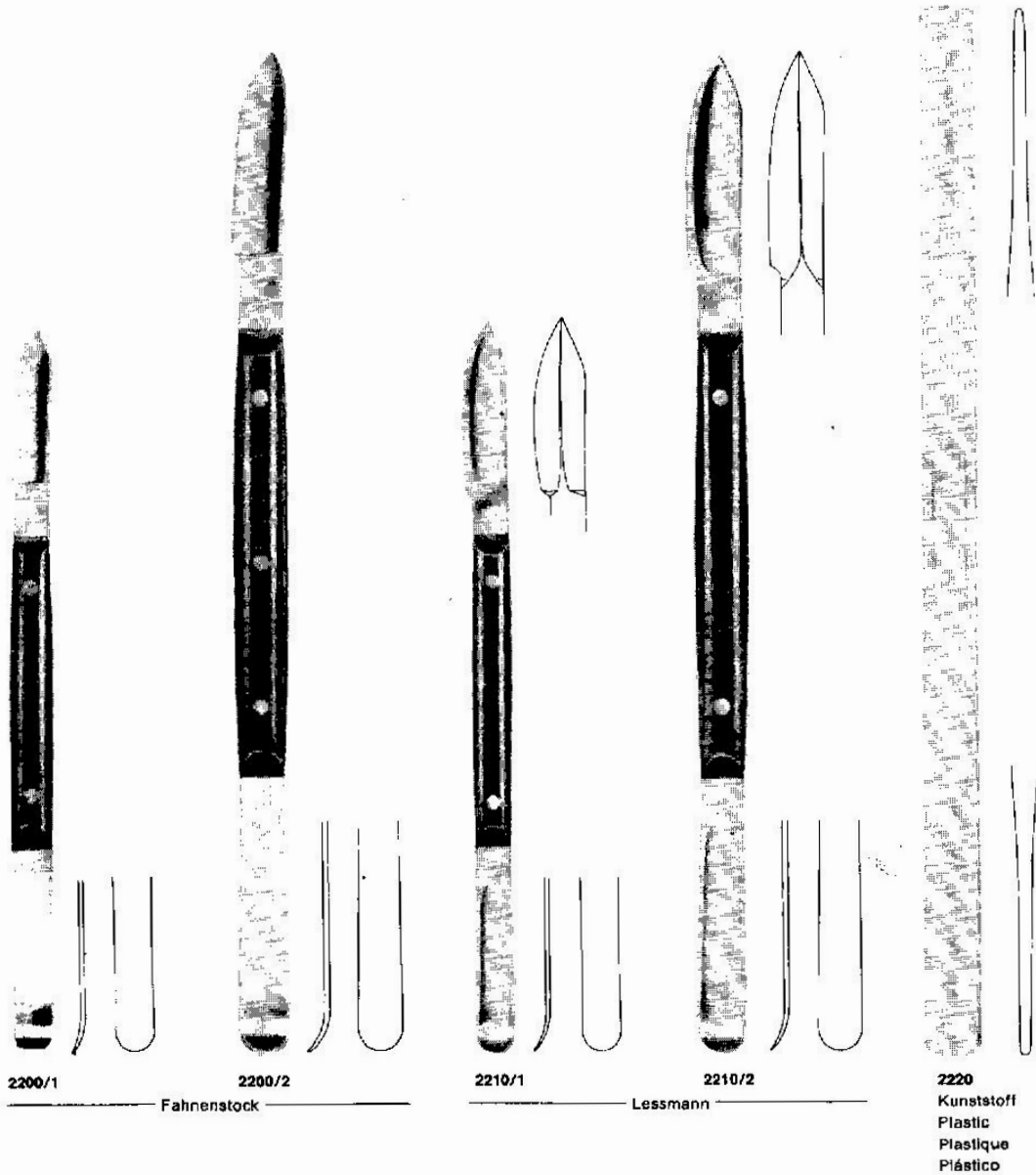

Zahnpinzetten Cotton pliers – Tweezers
Précelles – Brucelles
Pinzas para algodón

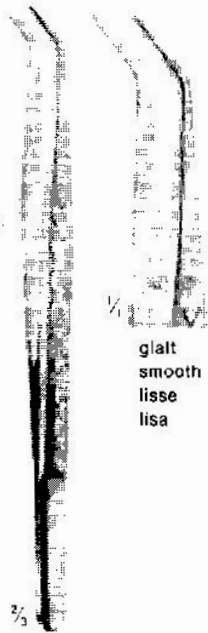

glatt
smooth
lisse
lisa

2250/1
College 15 cm

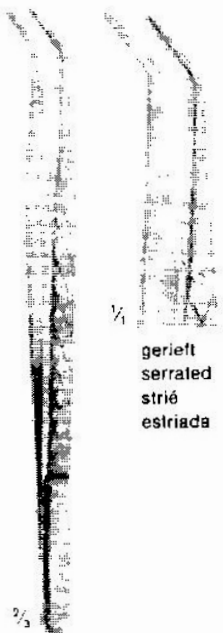

gerieft
serrated
strié
estriada

2250/2
College 15 cm

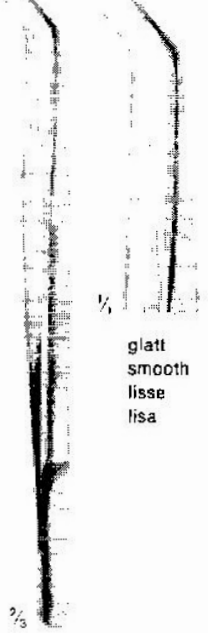

glatt
smooth
lisse
lisa

2255/1
College 15 cm

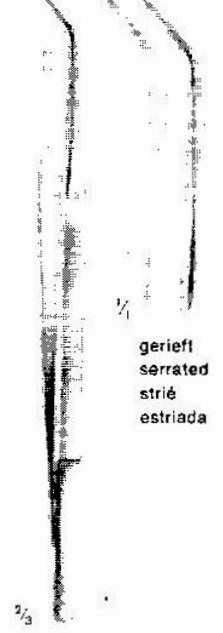

gerieft
serrated
strié
estriada

2255/2
College 15 cm

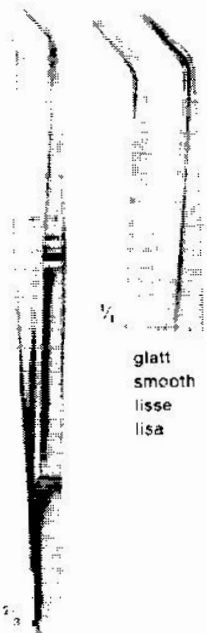

glatt
smooth
lisse
lisa

2260/1
College 15 cm

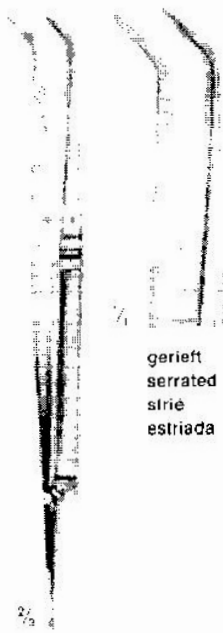

gerieft
serrated
strié
estriada

2260/2
College 15 cm



glatt
smooth
lisse
lisa

2265/1
Meriam 16 cm

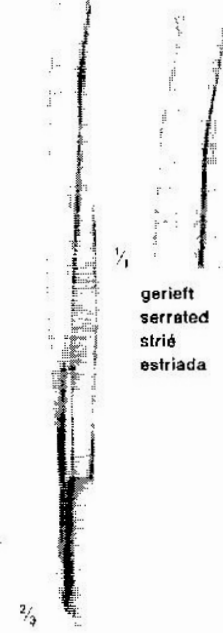

gerieft
serrated
strié
estriada

2265/2
Meriam 16 cm

Zahnpinzetten Cotton pliers – Tweezers
Précelles – Brucelles
Pinzas para algodón

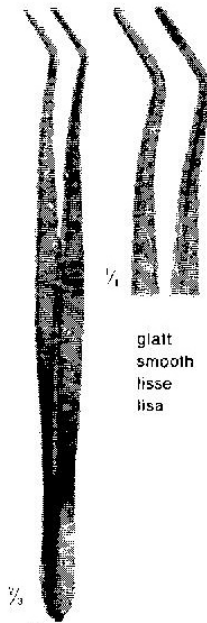

glatt
smooth
lisse
lisa

2270/1
Meriam 16 cm

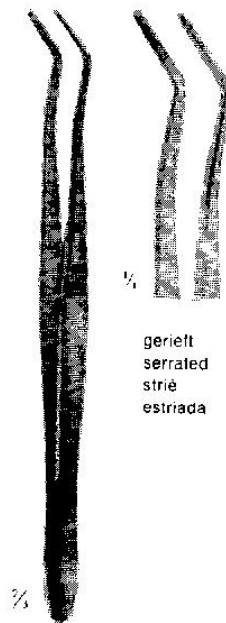

gerieft
serrated
strié
estriada

2270/2
Meriam 16 cm

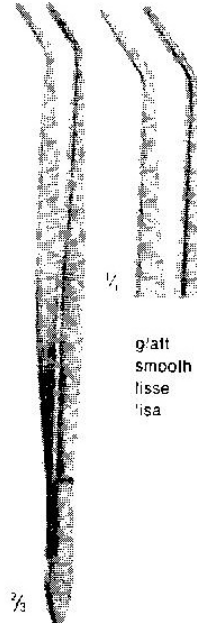

glatt
smooth
lisse
lisa

2275/1
Flagg 16 cm



gerieft
serrated
strié
estriada

2275/2
Flagg 16 cm

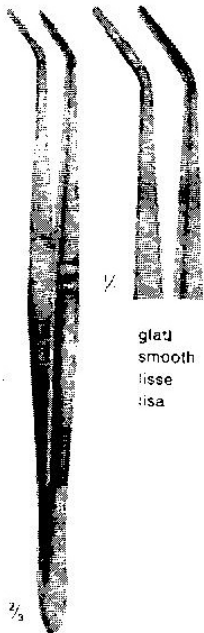

glatt
smooth
lisse
lisa

2280/1
Flagg 16 cm

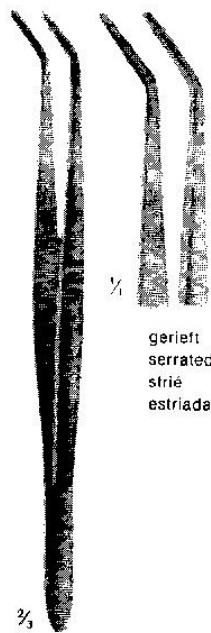

gerieft
serrated
strié
estriada

2280/2
Flagg 16 cm



glatt
smooth
lisse
lisa

2285/1
Perry 13 cm

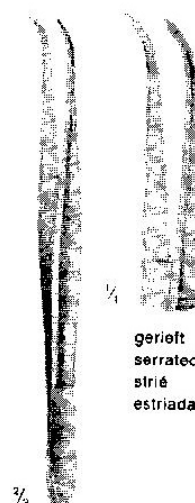

gerieft
serrated
strié
estriada

2285/2
Perry 13 cm

Speichelsauger	Saliva Ejectors – Tubes à salive – Tubos para saliva
Separatoren	Separators – Séparateurs – Separadores
Matrizenspanner	Matrix Retainers – Porte-matrices – Porta-matrices



Speichelsauger aus Metall
Saliva Ejectors (metal)
Tubes à salive (métal)
Tubos para saliva (metal)

2420



2435/3

2435/1

Zungen- und Watterollenhalter mit Kinnstütze, komplett
Tongue Depressor and Cotton Roll Holders with chin support, complete

Abaisse-langue avec abaisse-tampon, avec point d'appui mentonnier, complet
Abaja-lengua con soporte para rollos de algodón y sostén para el mentón, completo

für Erwachsene
for adults
pour adultes
para adultos

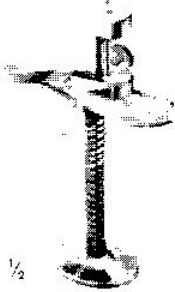

2430
Automaton

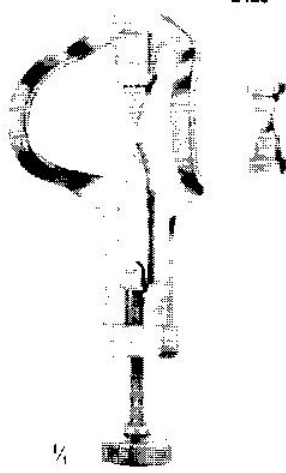

2450 – Ivory 14



2440/1

2440/2

2440/3

für Kinder – for children – pour enfants – para niños

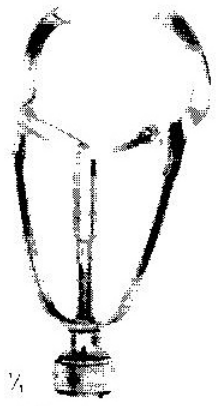

2460 – Ivory 12

Matrizenspanner
Matrix Retainers
Porte-matrices
Porta-matrices

für Molaren
for Molars
pour Molaires
para Molares

für Prämolaren
for Premolars
pour Prémolaires
para Premolares



2465/1

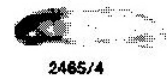

2465/4



2465/2



2465/5



2465/3



2465/6

in Packungen zu 12 Stück
packages of 12 bands
emballages à 12 rubans
paquetes de 12 bandas

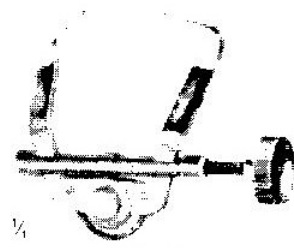

2455 – Elliot 16

Separatoren
Separators
Séparateurs
Separadores



Kofferdam-Lochzangen

Rubber-Dam Punch – Perforateur a digue
Perforador para dique de caucho

Kofferdam-Klammerzangen

Rubber-Dam Clamp Forceps – Pincas porte-crampons à digue
Pinzas de engrapar para dique de caucho

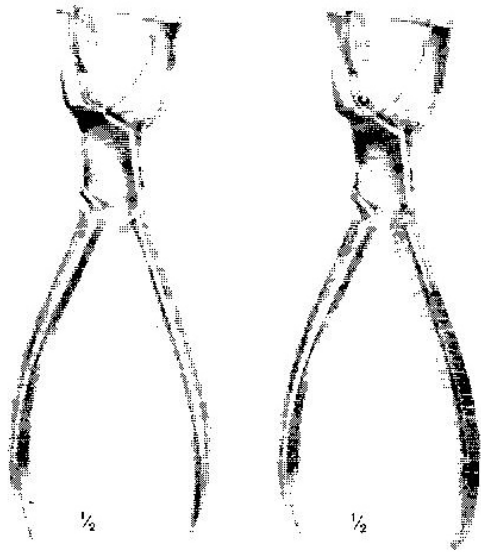

2550/1

2550/2

Ainsworth



2555/1
Ivory

mit einer Lochreihe
with 1 row of holes
avec 1 rangée de trous
con una serie de agujeros

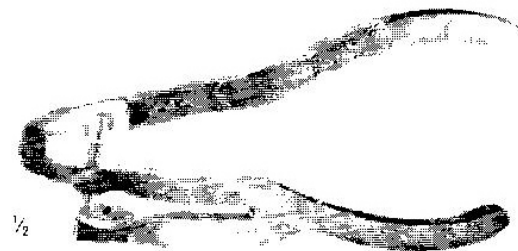
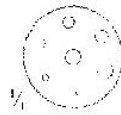

2555/2
Ivory

mit 2 Lochreihen
with 2 rows of holes
avec 2 rangées de trous
con 2 series de agujeros

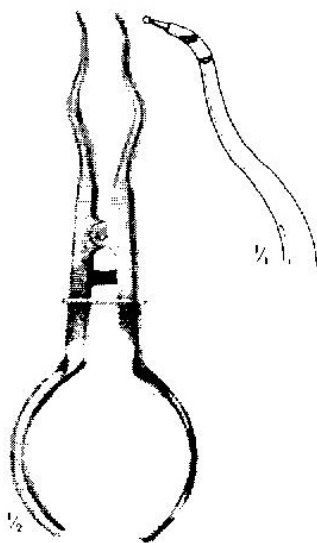

2560/1
Brewer

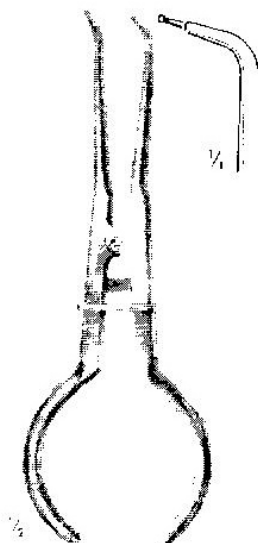

2560/2
Stockes

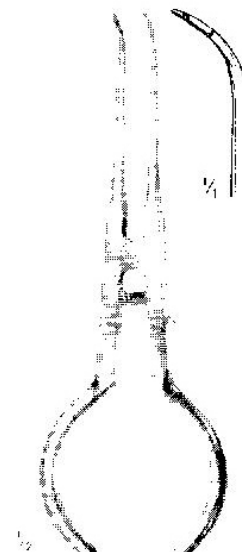

2560/3
Palmer

Kronenscheren Crown Scissors – Ciseaux à couronnes – Tijeras para coronas
Sterilisierzangen Sterilizing Forceps – Pinces à stérilisation –
 Pinzas para esterilización –

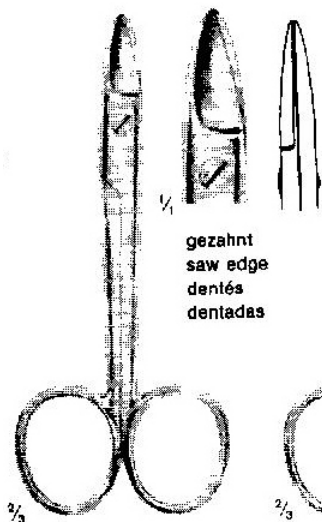

2620/1
12 cm

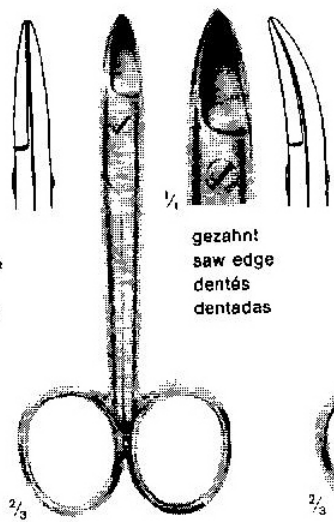

2620/2
12 cm

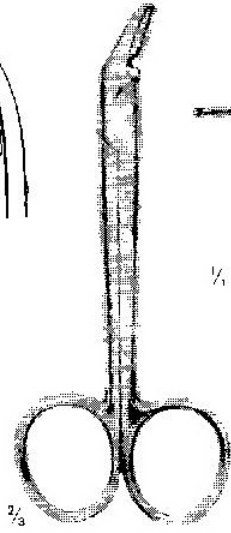

2625
Universal
12 cm

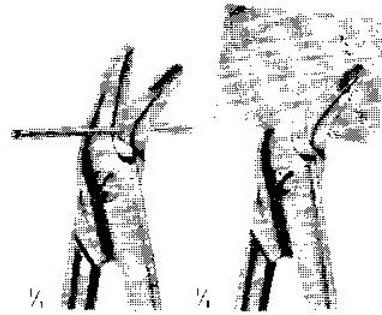

gezahnt
saw edge
dentés
dentadas

gezahnt
saw edge
dentés
dentadas



2630
Rogge
23 cm

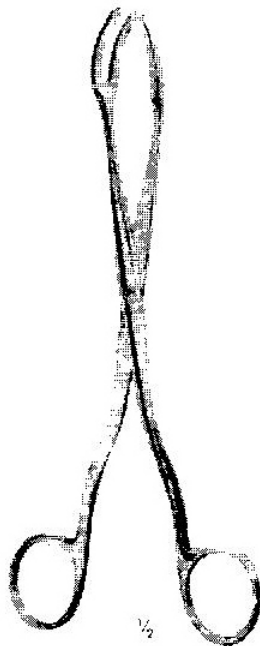

2635/1
20 cm



2635/2
30 cm

Zangen für Kieferorthopädie und Prothetik
 Pliers for orthodontics and prosthetics
 Pinces pour l'orthodontie et la prothèse
 Alicates para ortodoncia y prótesis

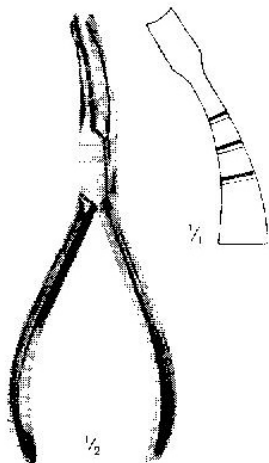

2710
Angle
14.5 cm

Bandformzange
 Band forming plier
 Pince à former les bagues
 Alicata para formar bandas

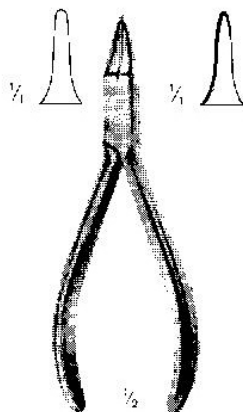

2715
Peeso
13 cm

Kronenbänderzangen
 Collar Pliers
 Pinces pour bandes à couronnes
 Alicates para cuellos

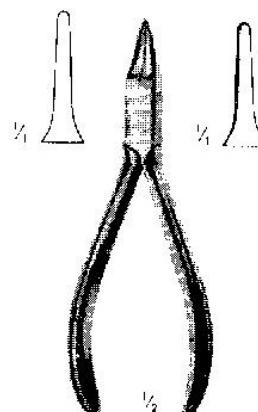

2720
Peeso
13 cm

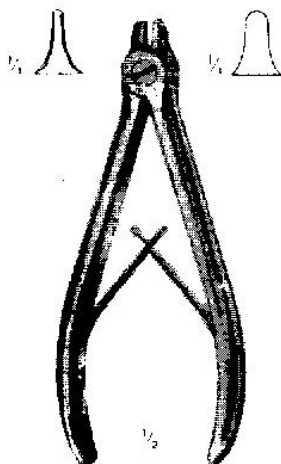

2725
Peeso
14.5 cm

Kronenstreckzangen
 Crown stretching pliers
 Pinces à étendre les couronnes
 Alicates para ensanchar coronas

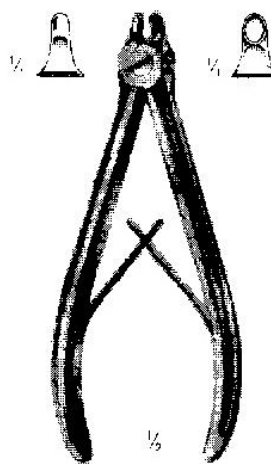

2730
14.5 cm



2735
14.5 cm

Zange flach/rund
 Plier flat and round
 Pince plate et ronde
 Alicata plano y redondo

**Zangen für
Kieferorthopädie
und Prothetik**

Pliers for orthodontics and prosthetics
Pinces pour l'orthodontie et la prothèse
Alicates para ortodoncia y prótesis

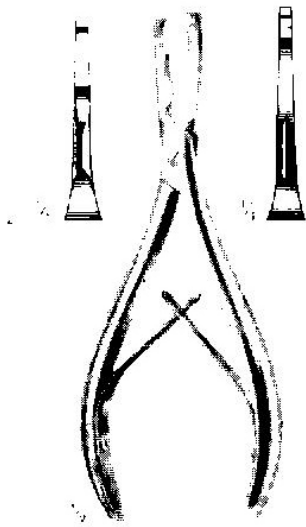

**2770
Tryfus**
16,5 cm

Kronenformzange
Crown Forming Plier
Pince pour former les couronnes
Alicata para formar coronas

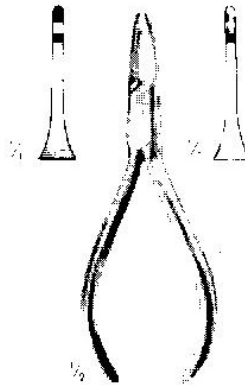

**2775
Johnson**
12 cm

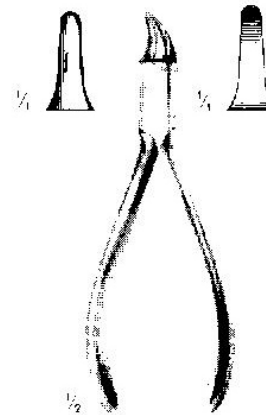

**2780
Reynolds**
23 cm

Konturzangen
Contouring Pliers
Pinces à bouleroller
Alicates para contornear

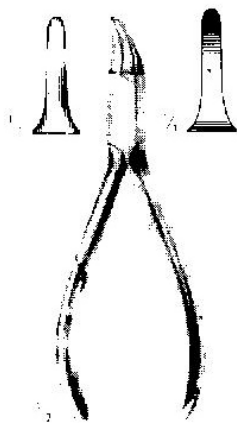

**2785
Gordon**
13,5 cm

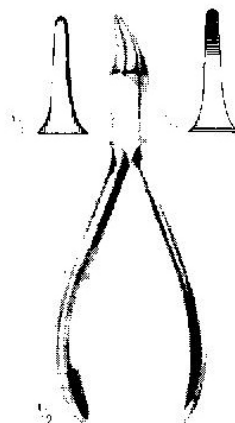

**2790
USA Model**
13,5 cm

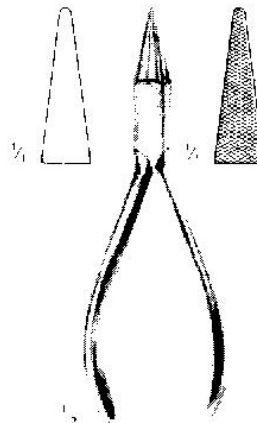

**2795
Goslee**
13,5 cm

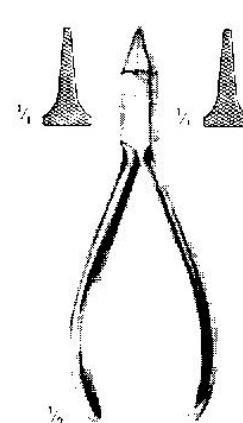

**2800
Frevert**
13 cm

Konturzangen
Contouring Pliers
Pinces à bouleroller
Alicates para contornear

Zangen für Kieferorthopädie und Prothetik
 Pliers for orthodontics and prosthetics
 Pinces pour l'orthodontie et la prothèse
 Alicates para ortodoncia y prótesis

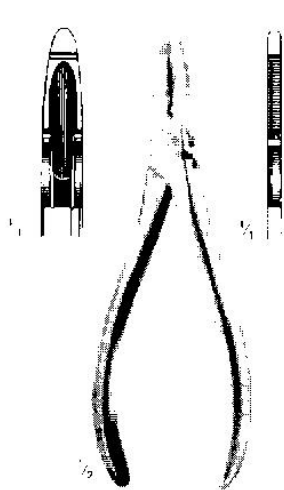

2805
Waldsachs
15 cm

Klammer- und Bügelbiegezange
 Clasp and Bar Bending Plier
 Pince à plier crochets et barres
 Alicates para doblar ganchos y barras



2810
16 cm

Universal-Kramporzangen
 Pin Roughening-Cutting and Bending Pliers
 Pinces universelle pour crampons
 Alicates para poner asperas

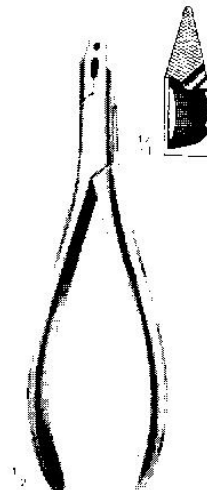

2815
16 cm

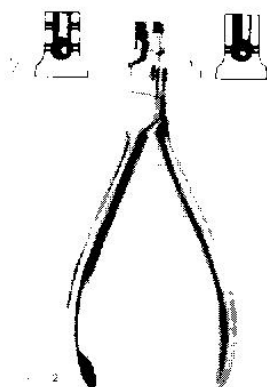

2820
Schwarz
12.5 cm

Pfeilformzange
 Arrow head clasp forming plier
 Pince à former les flèches
 Pinza para formar las flechas

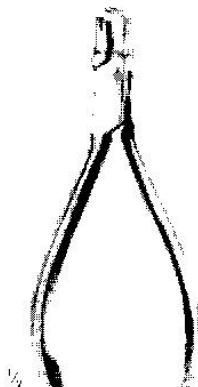

2825
Schwarz
13 cm

Pfeilknickzange
 Arrow head clasp bending plier
 Pince pour plier les flèches
 Pinza para doblar las flechas

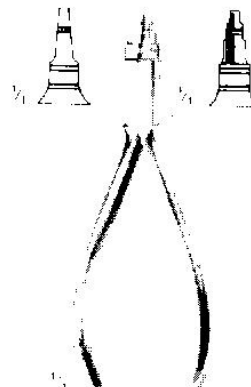

2830
Young
13 cm

Drahtbiegezange
 Wire Bending Plier
 Pince à courber les fils
 Alicates para doblar alambre

**Zangen für
Kieferorthopädie
und Prothetik**

Pliers for orthodontics and prosthetics
Pinces pour l'orthodontie et la prothèse
Alicates para ortodoncia y prótesis

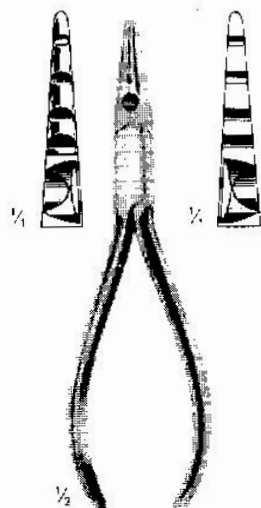

2835
Reichle
16 cm

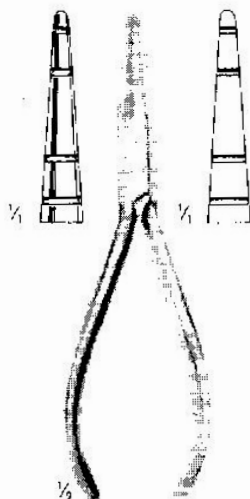

2840
Jelenko
16 cm

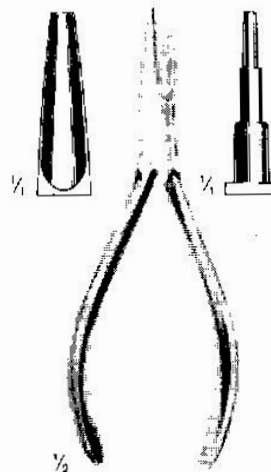

2845
15 cm

Draht- und Klammerbiegezeugen
Wire and Clasp Bending Pliers
Pinces à plier les fils et les crochets
Alicates para doblar alambre y ganchos

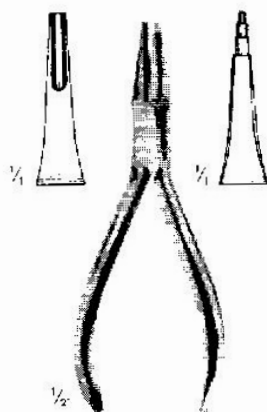

2850
Tweed
13,5 cm

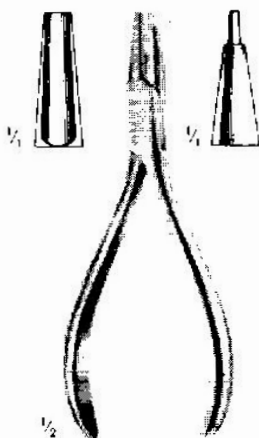

2855
Andresen
14 cm

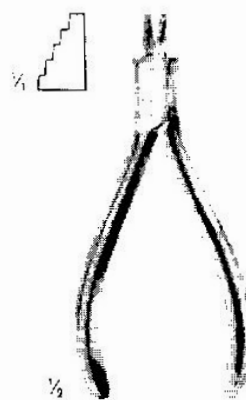

2860
Nence
13 cm

Draht- und Klammerbiegezeugen
Wire and Clasp Bending Pliers
Pinces à plier les fils et les crochets
Alicates para doblar alambre y ganchos

**Zangen für
Kieferorthopädie
und Prothetik**

Pliers for orthodontics and prosthetics
Pincers pour l'orthodontie et la prothèse
Alicates para ortodoncia y prótesis

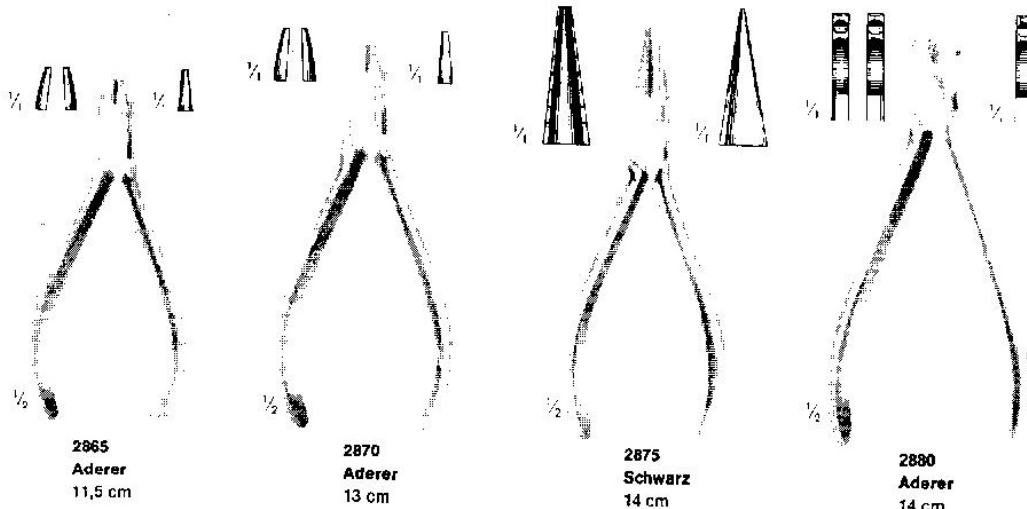

Draht- und Klammerbiegezaugen
Wire and Clasp Bending Pliers
Pincers à plier les fils et les crochets
Alicates para doblar alambre y ganchos

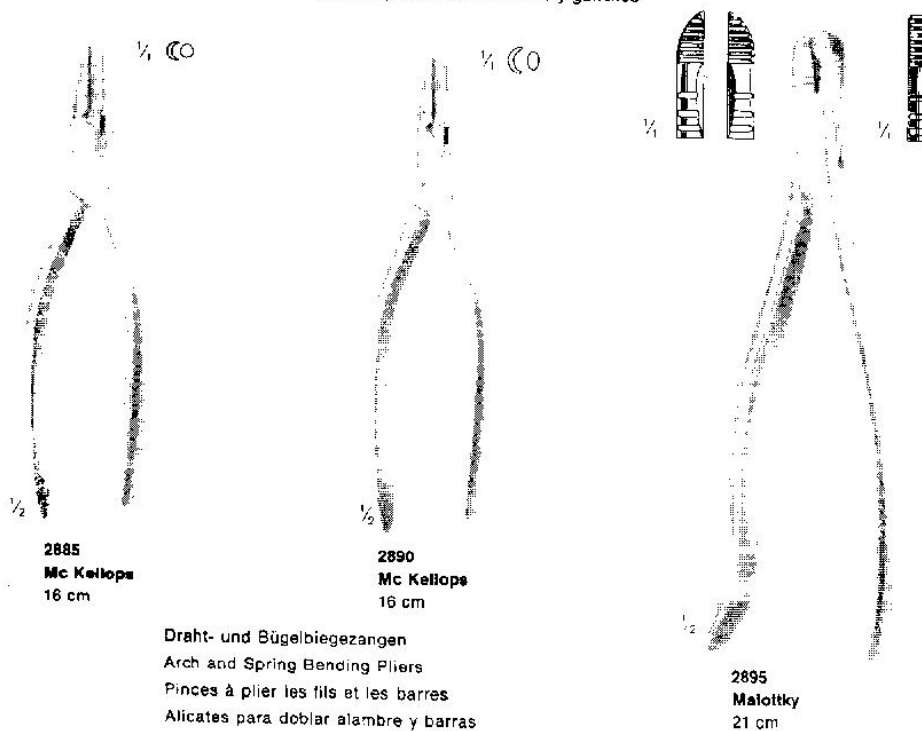

Draht- und Biegelbiegezaugen
Arch and Spring Bending Pliers
Pincers à plier les fils et les barres
Alicates para doblar alambre y barras

Zangen für Kieferorthopädie und Prothetik Pliers for orthodontics and prosthetics
Pincès pour l'orthodontie et la prothèse
Alicates para ortodoncia y prótesis

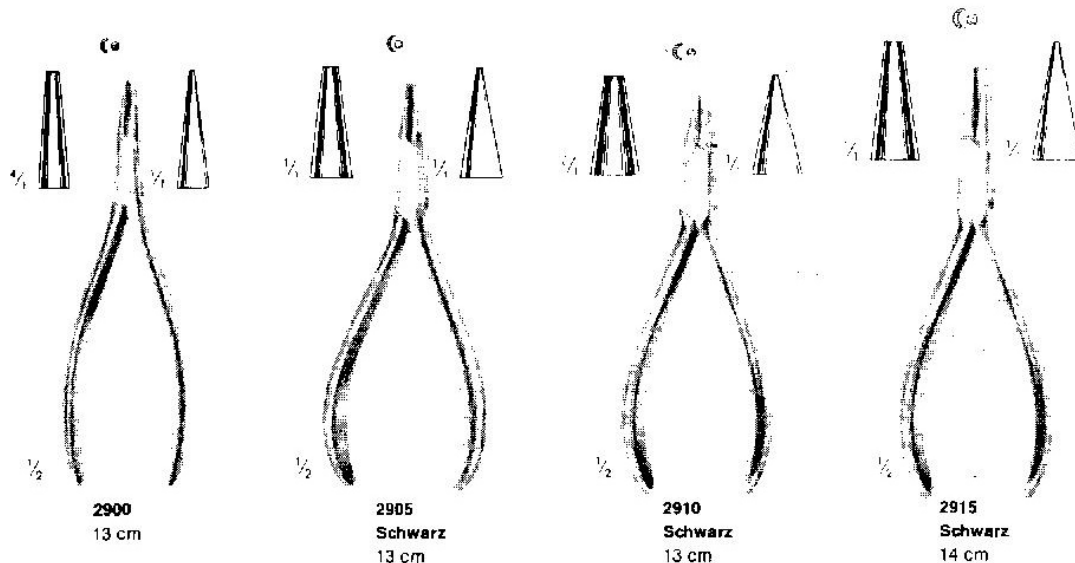

Draht- und Biegelbiegezangen
Arch and Spring Bending Pliers
Pincès à plier les fils et les barres
Alicates para doblar alambre y barras

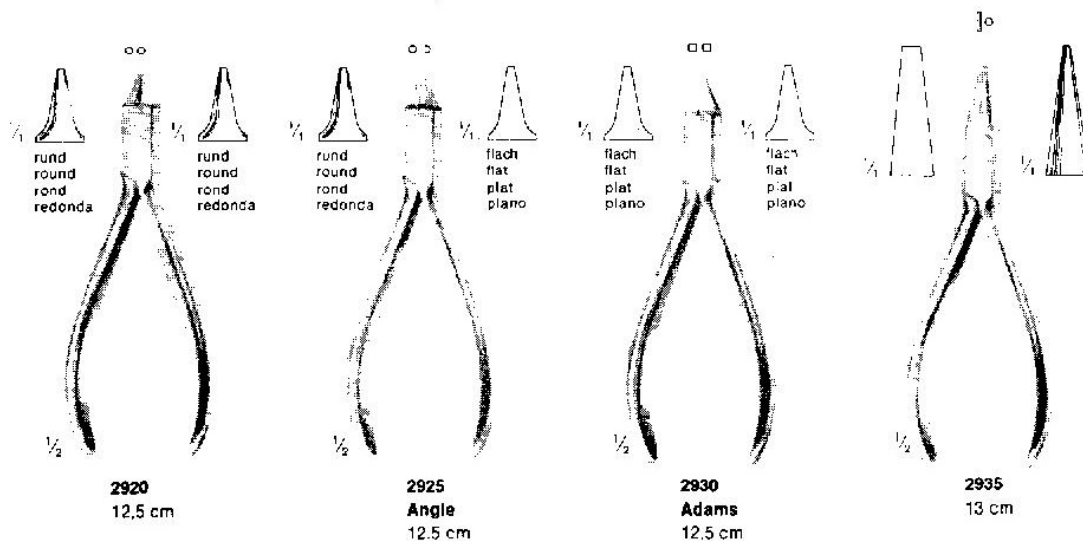

Drahtbiegezangen
Wire Bending Pliers
Pincès à plier les fils
Alicates para doblar alambre



Cavity Preparation Instruments	Schmelzinstrumente Instrumentos Para Esmalte Instruments A Email
---------------------------------------	--

CUTTING INSTRUMENTS
HATCHETS

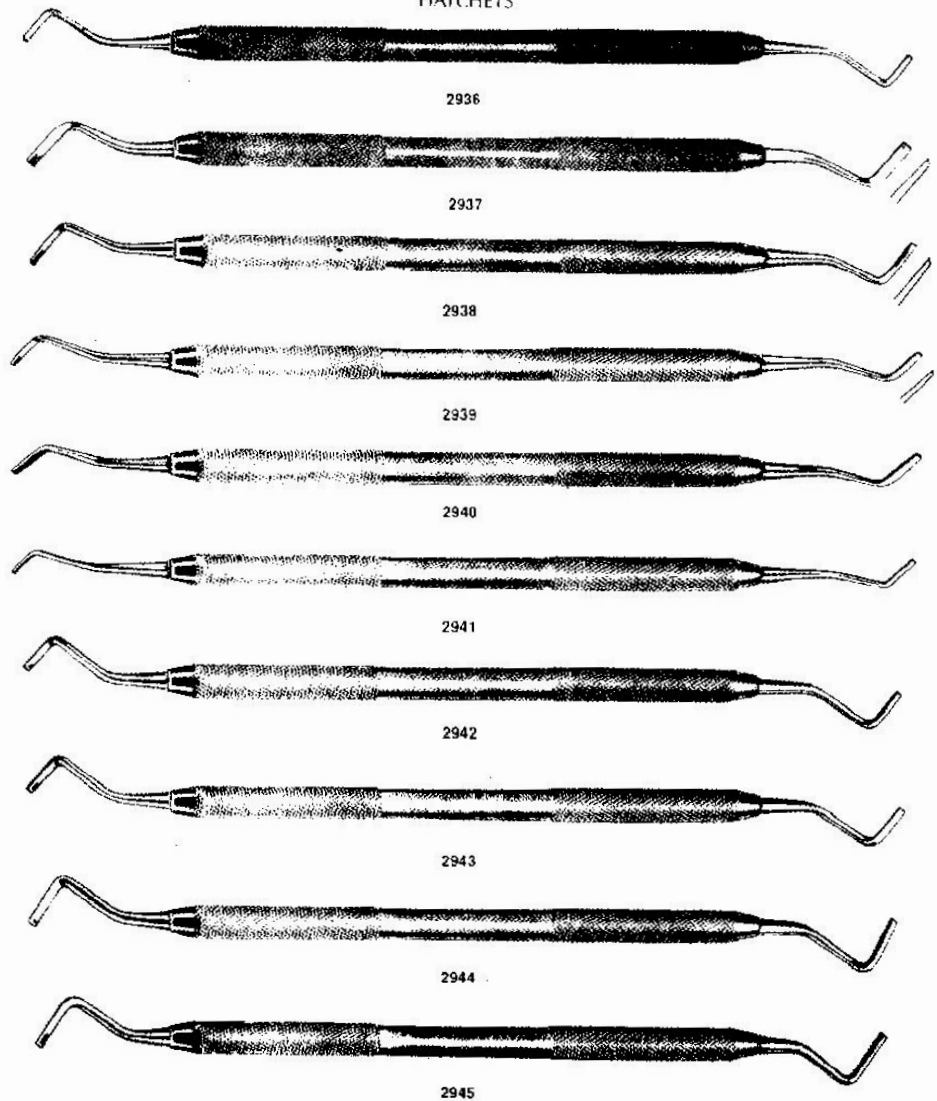

Used primarily to prepare retentive areas, sharpen internal line angles, and remove hard caries

Cavity Preparation Instruments

Schmelzinstrumente
Instrumentos Para Esmalte
Instruments A Email

CUTTING INSTRUMENTS
CHISELS

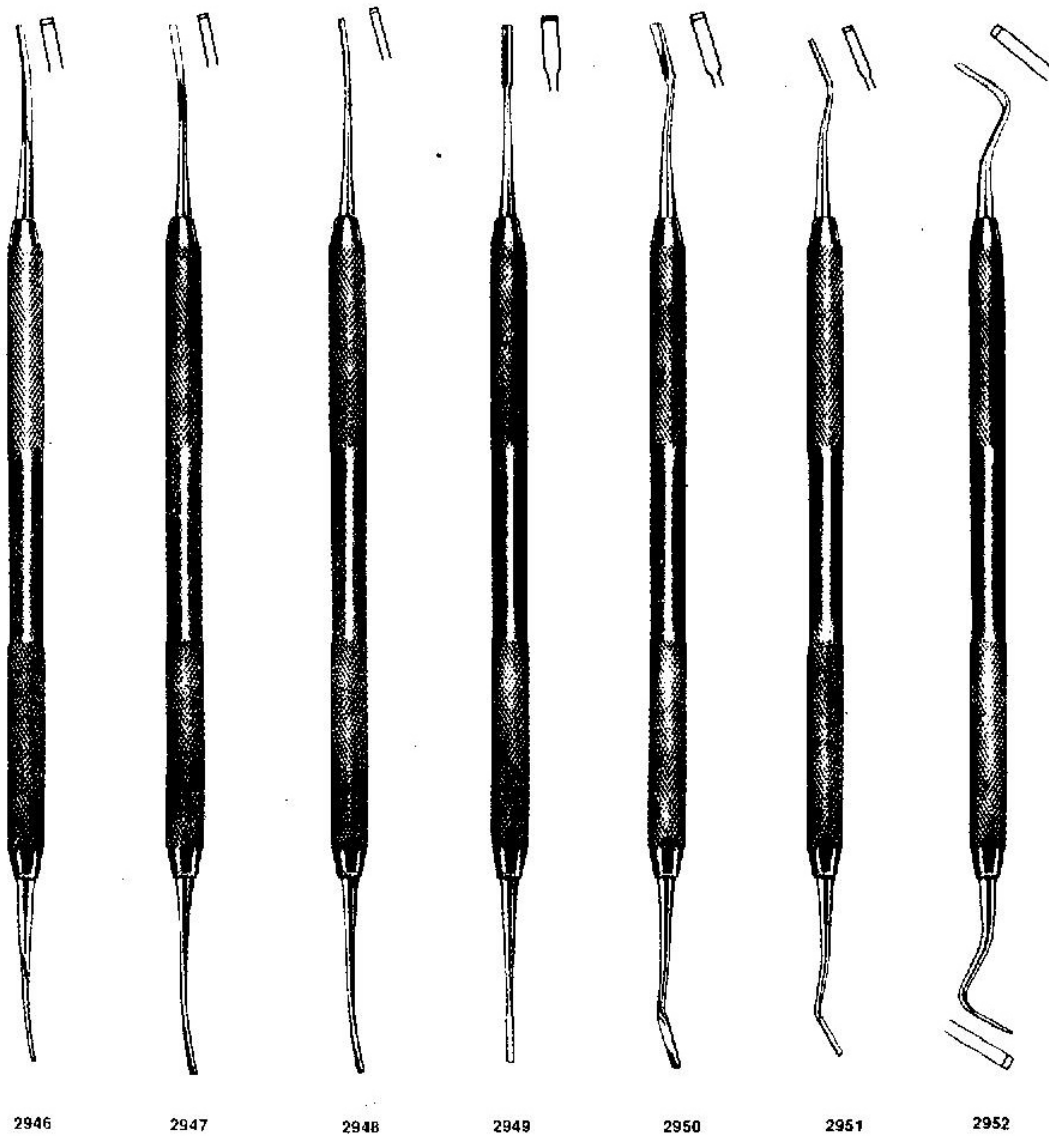

For use in planing and cleaving enamel.

†Available Single-End: 7 Straight [15] [CP7].



DENTAL INSTRUMENTS

Cavity Preparation Instruments
Schmelzinstrumente
Instrumentos Para Esmalte
Instruments A Email

CUTTING INSTRUMENTS

HOES

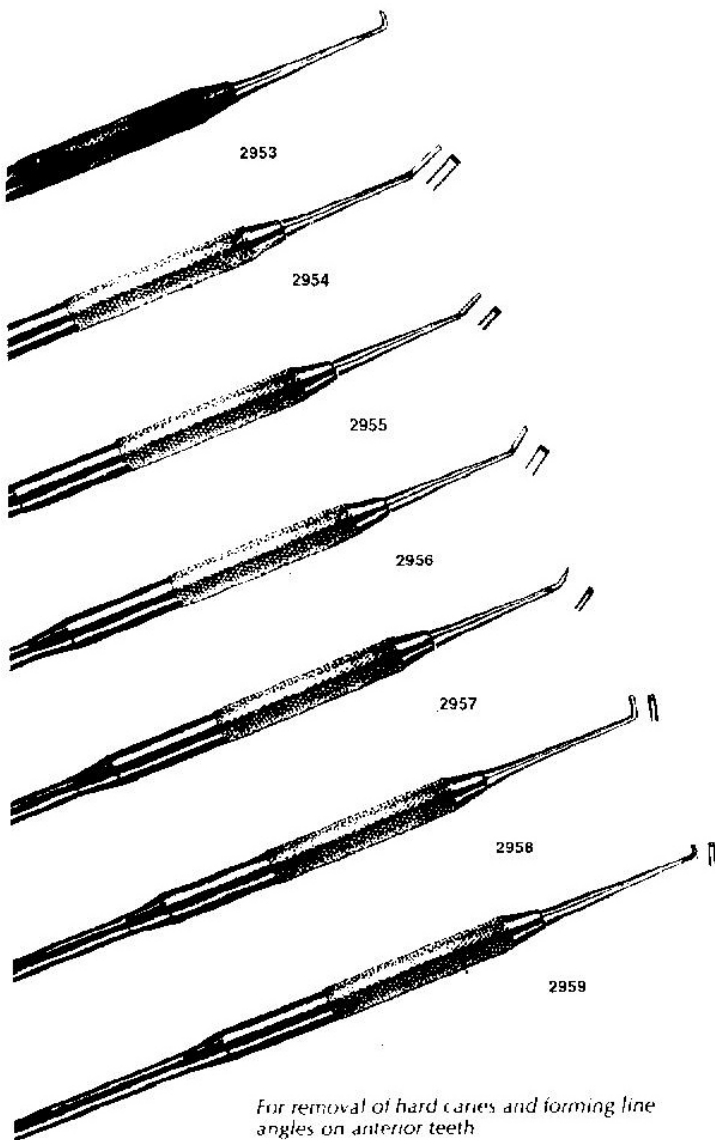

For removal of hard caries and forming line angles on anterior teeth

All Hoes available Double-End.
Specify: 19/19C (CP19/19C), 20/20C (CP20/20C),
21/21C (CP21/21C), 22/22C (CP22/22C),
23/23C (CP23/23C), 24/24C (CP24/24C),
or 25/25C (CP25/25C)

ANGLE FORMERS



For defining line angles, obtaining retentive form in dentin, and placing bevels on enamel margins.



<p>Cavity Preparation Instruments</p>	<p>Schmelzinstrumente Instrumentos Para Esmalte Instruments A Email</p>
--	---

MARGIN TRIMMERS

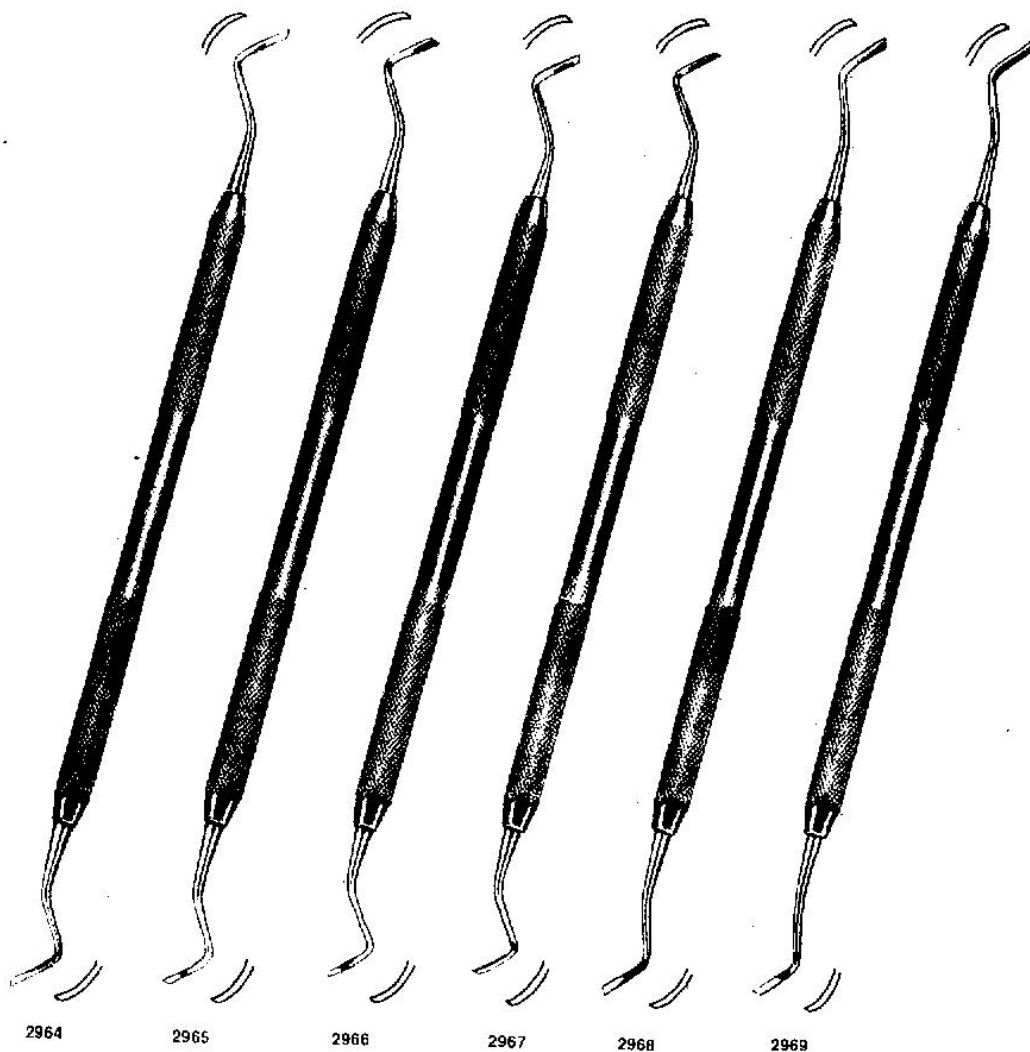

Used primarily to produce proper bevel on gingival enamel margins. Similar to Enamel Hatchet, except blade is curved and cutting edge is at an angle to blade.

Operative Instruments Instrumente Fur Die Konservierende Behandlung
 Instrumentos Para Operatorial
 Instruments Pour D.O.

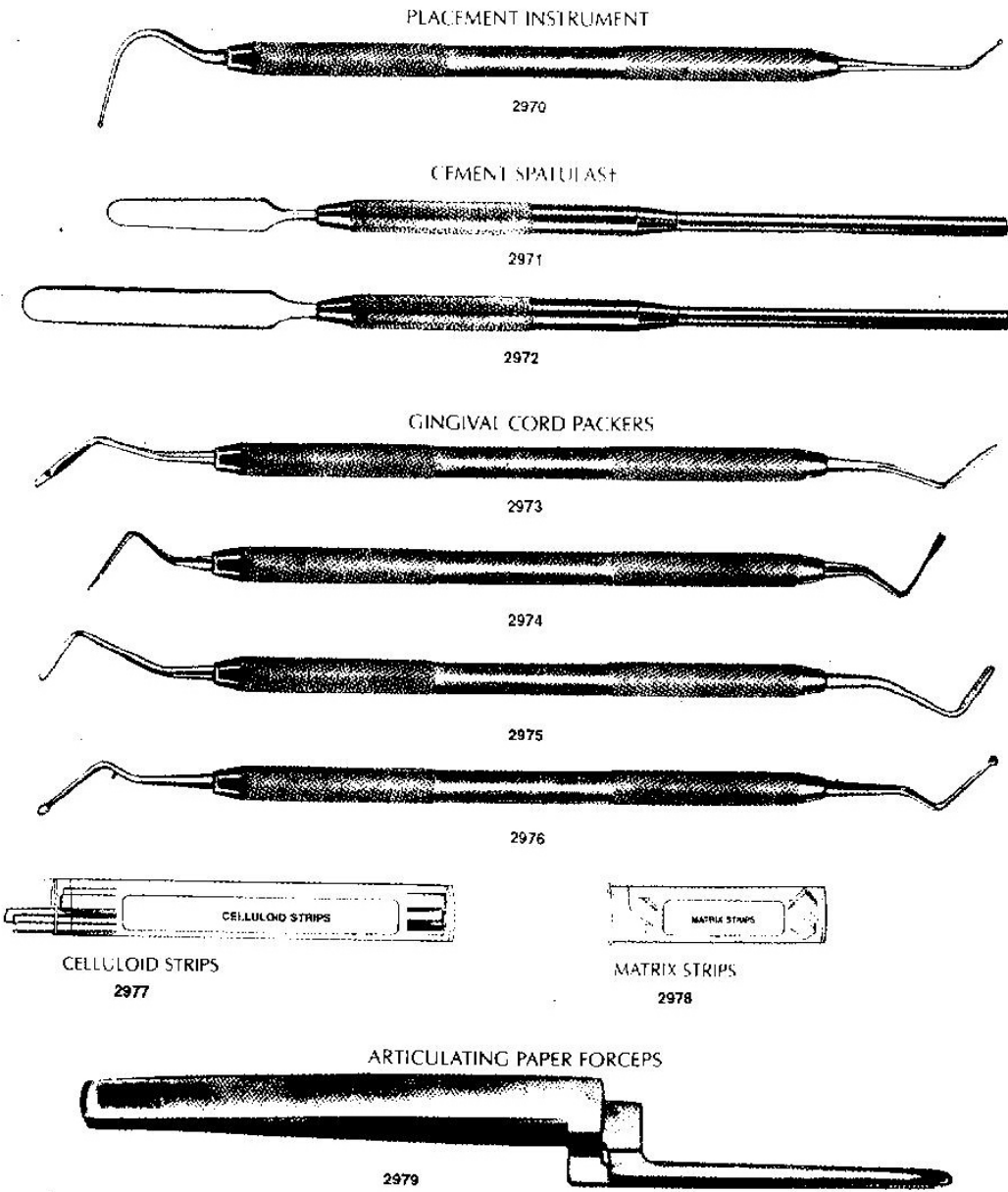

*Also available Non-Serrated

†Also see Laboratory Cement Spatulas at the end of this section

Excavators

Exkavatoren
Excavadores
Excavateurs

EXCAVATORS

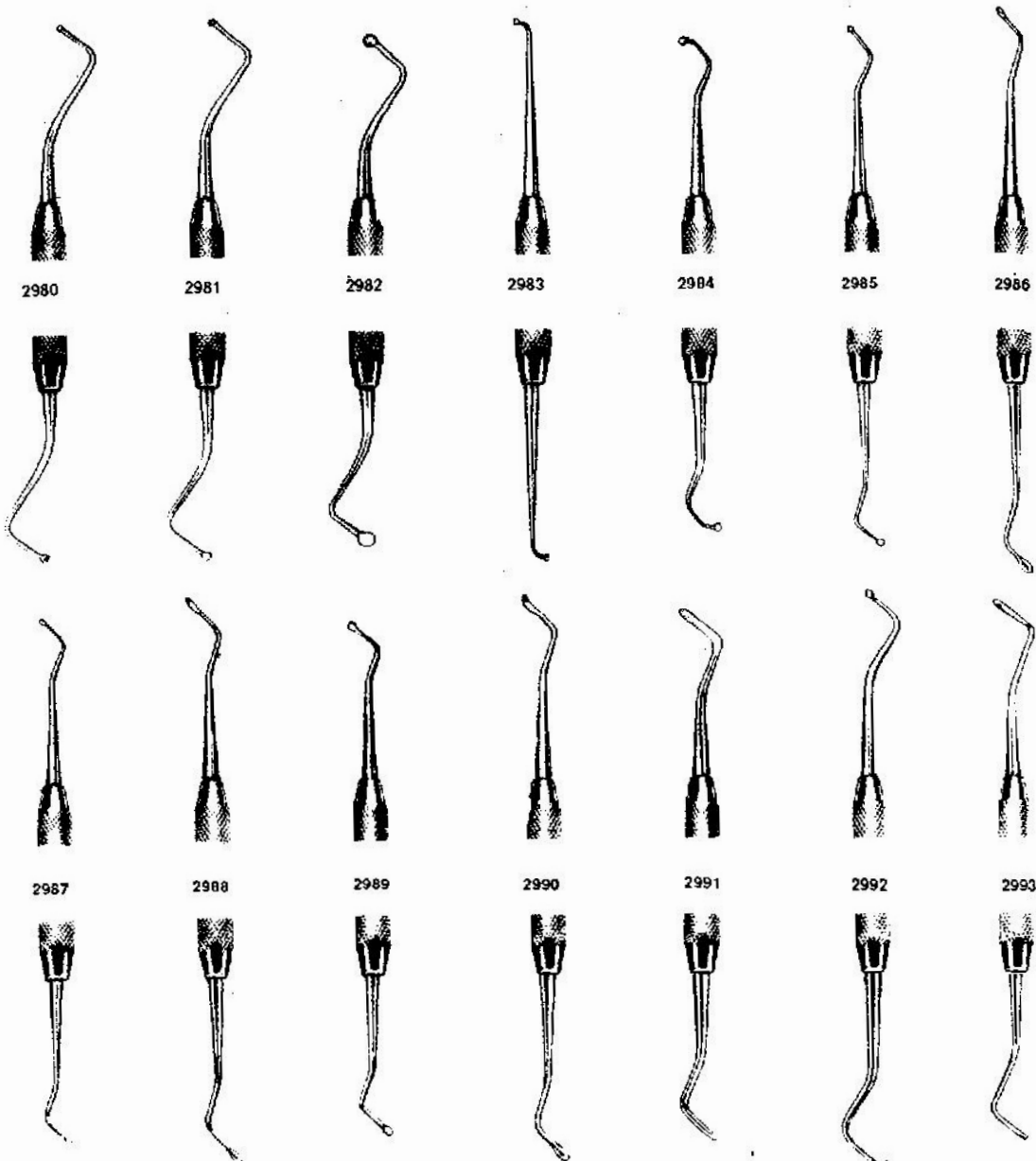

For removal of softer caries. Can also be used in carving amalgam and direct wax patterns.



Excavators
Exkavatoren
Excavadores
Excavateurs

ENGLISH PATTERNS

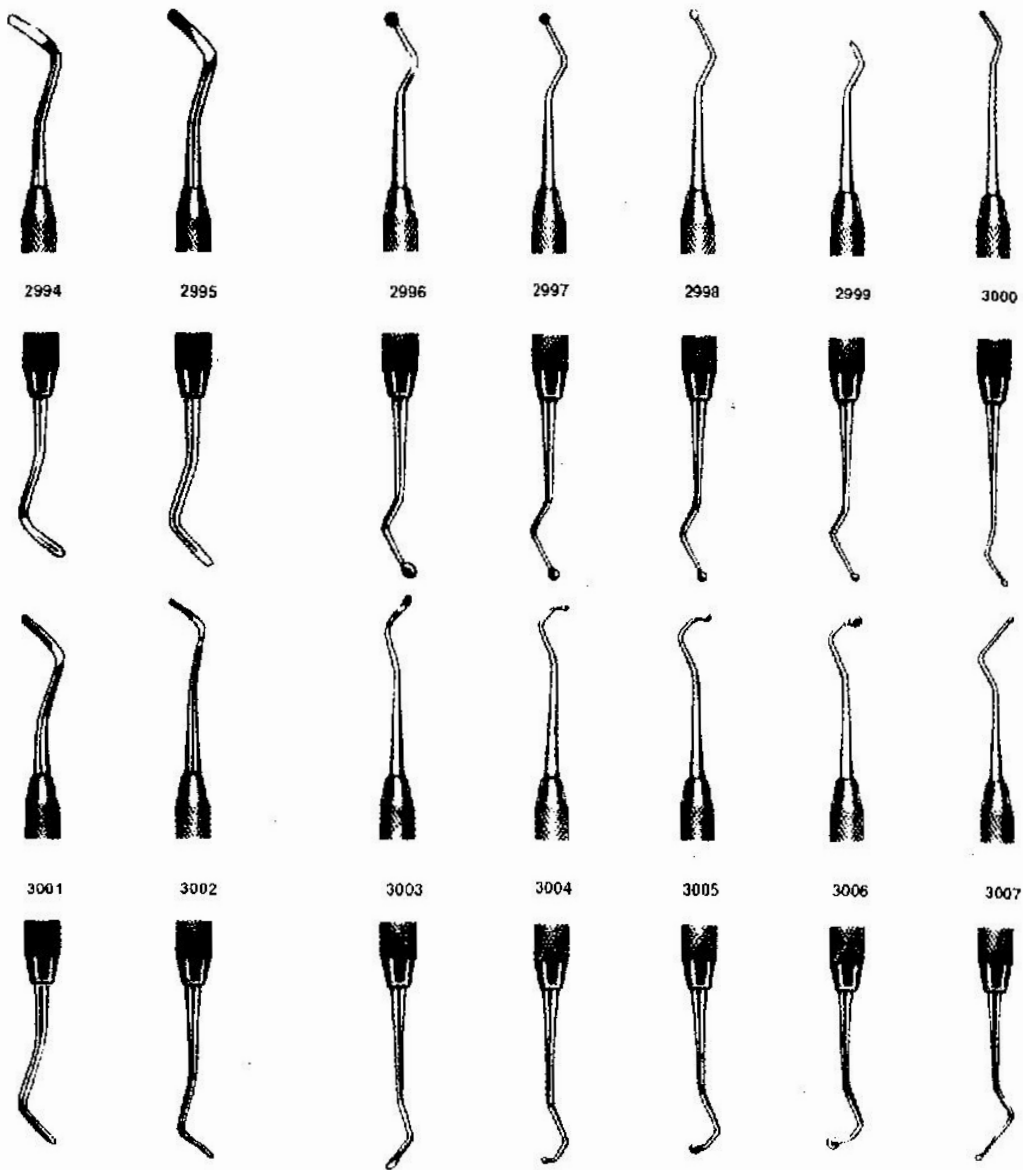



Amalgam Instruments

Amalgam Instrumente
Instrumentos Para Amalgama
Instrumentos A Amalgame

CF-II AMALGAM CARRIERS

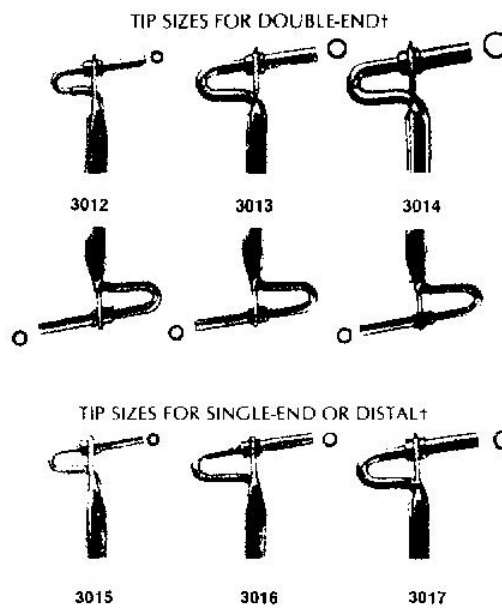
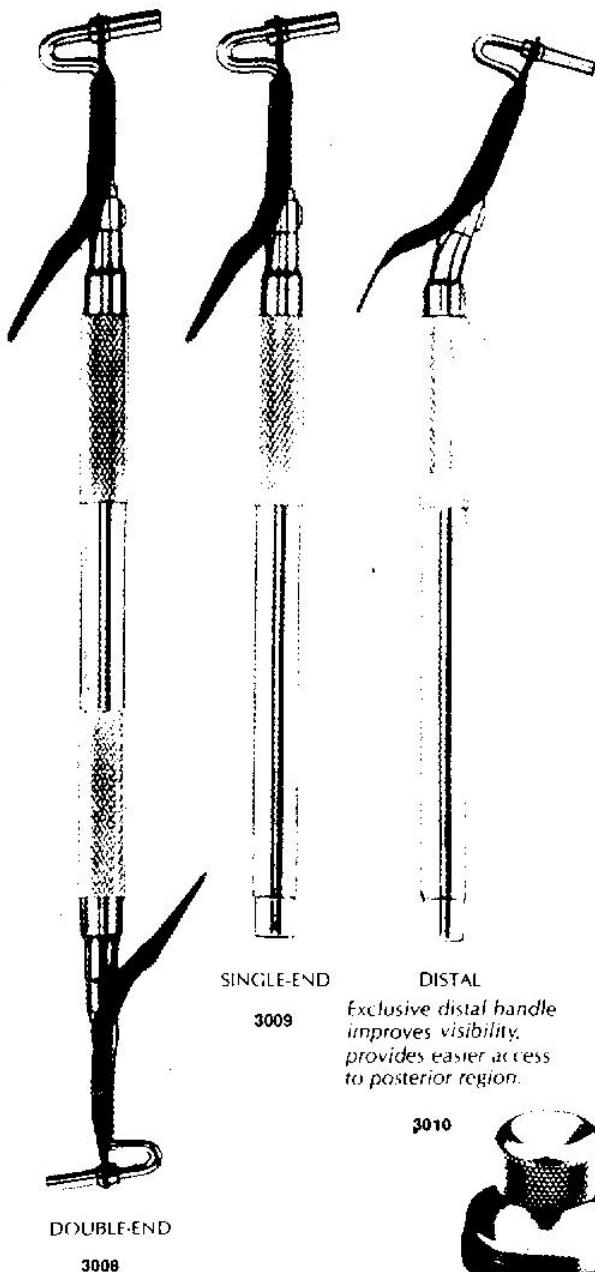

PERMANENT, ABRASION-RESISTANT COATING PREVENTS HARMFUL CLOGGING

SYNCOTE™ coating eliminates damaging wear caused by normal amalgam abrasion during usage (primary cause of carrier failure), prevents amalgam particles from interfering with dispensing action.

Amalgam

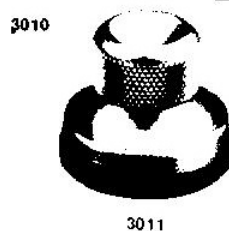

AMALGAM WELL
Stainless steel, with removable non-slip base ring. Designed for easy amalgam handling. (WA)

(Alternate sizes available by special order.)



Amalgam Instruments	Amalgam Instrumente Instrumentos Para Amalgama Instruments A Amalgame
----------------------------	---

BURNISHERS

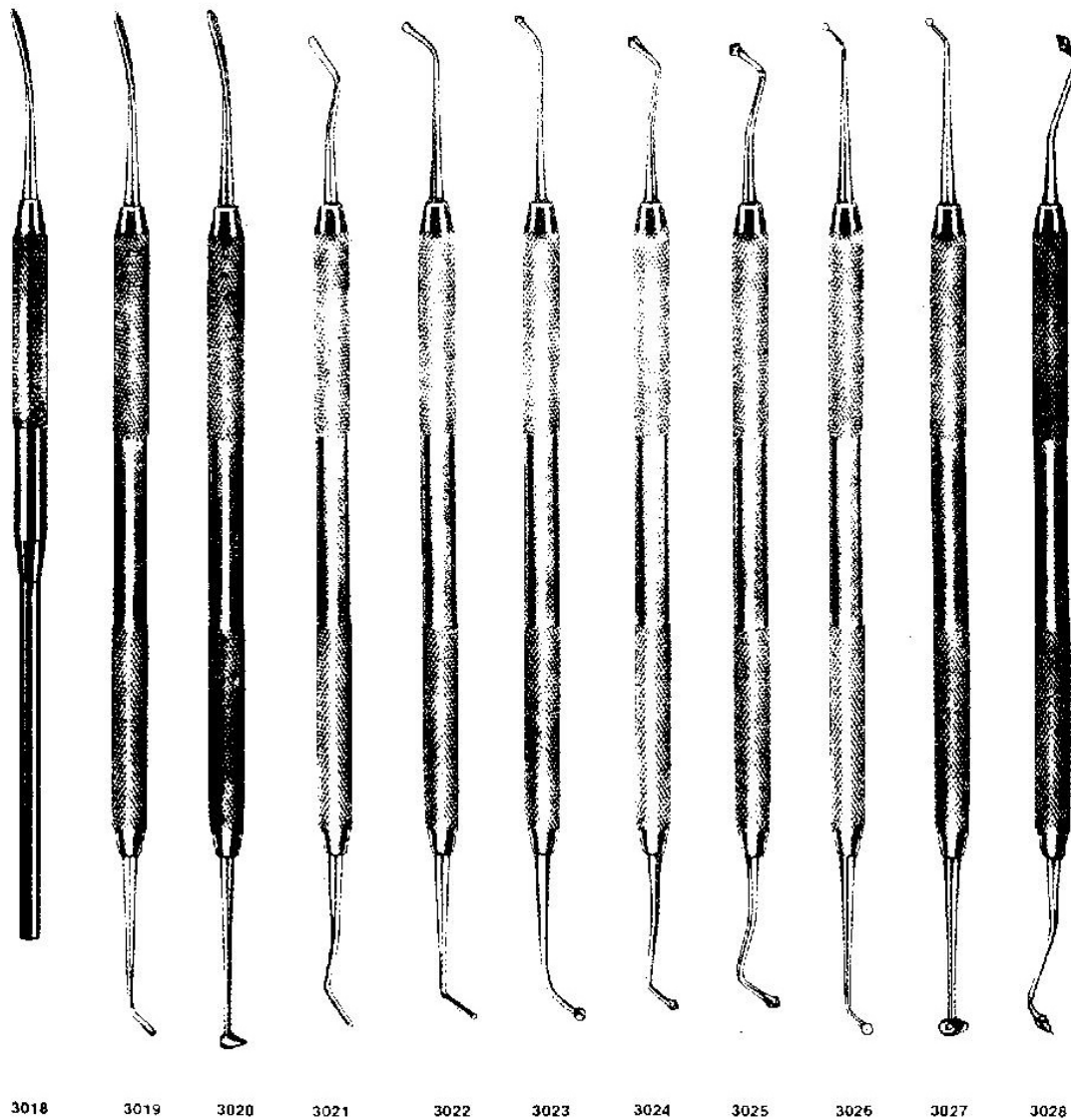

Designed to condense, smooth, and polish amalgam.

**Plastic Filling/
Composite
Instruments**

Instrumente Fur Plastische Fullungen Und Composite
Instrumentos para Obturaciones Plastica Y Composite
Instruments Pour Plombages Plastique Et Composite

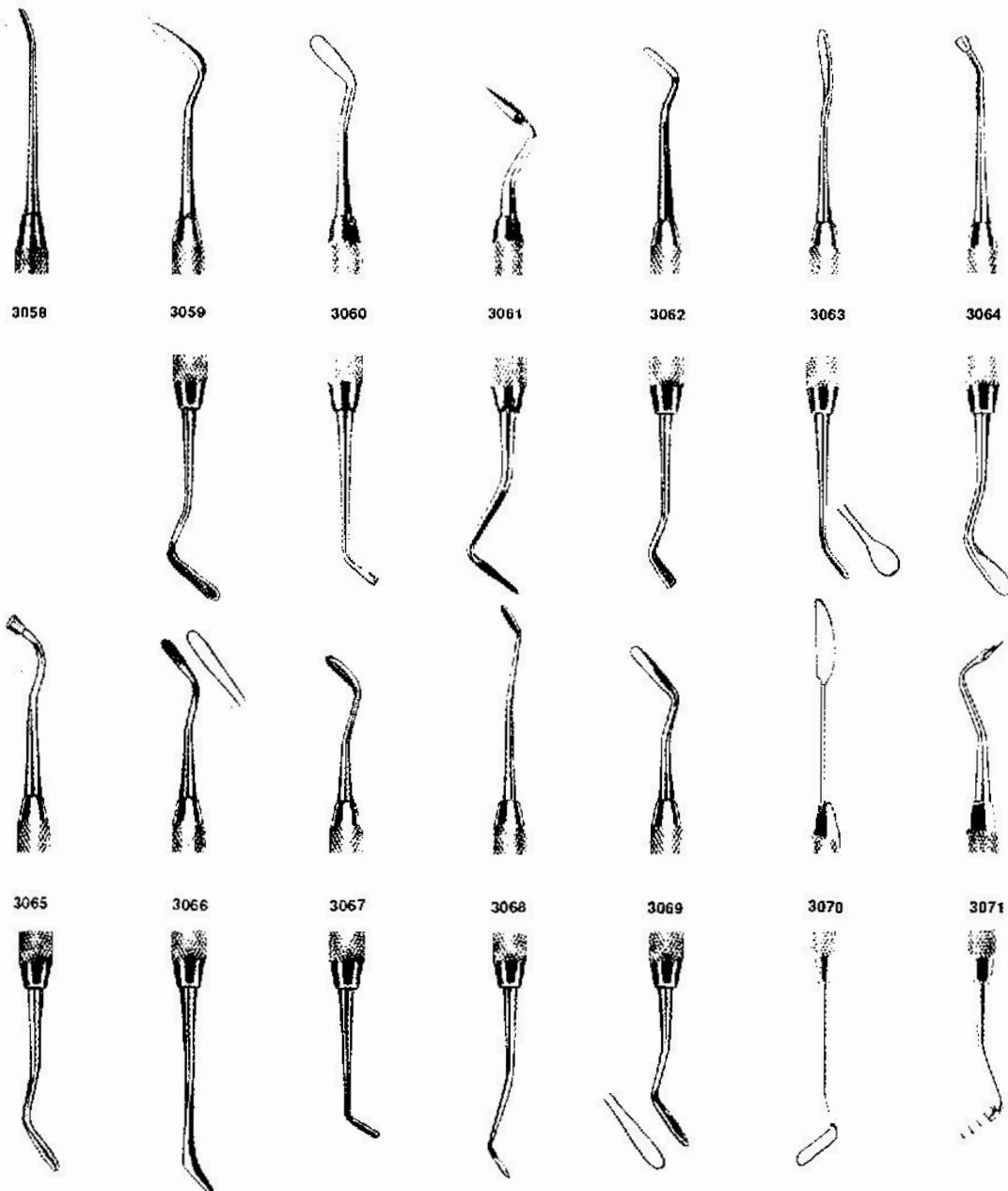

Useful for composite material application, including the newer light-cured composites.

Also see pages 9-C (BB21), 14C (CVIPC, CVIPCOA), 18-C (PKT3R).



Wax, Porcelain, And Modeling Carvers Wachs, Porzellan, Und Modellier Instrumente
 Talladores Y Espatulas Para Cera Porcelana, Y Para Modelar
 Instruments Et Spatules A Cire, A Porcelaine, Et A Sculpter

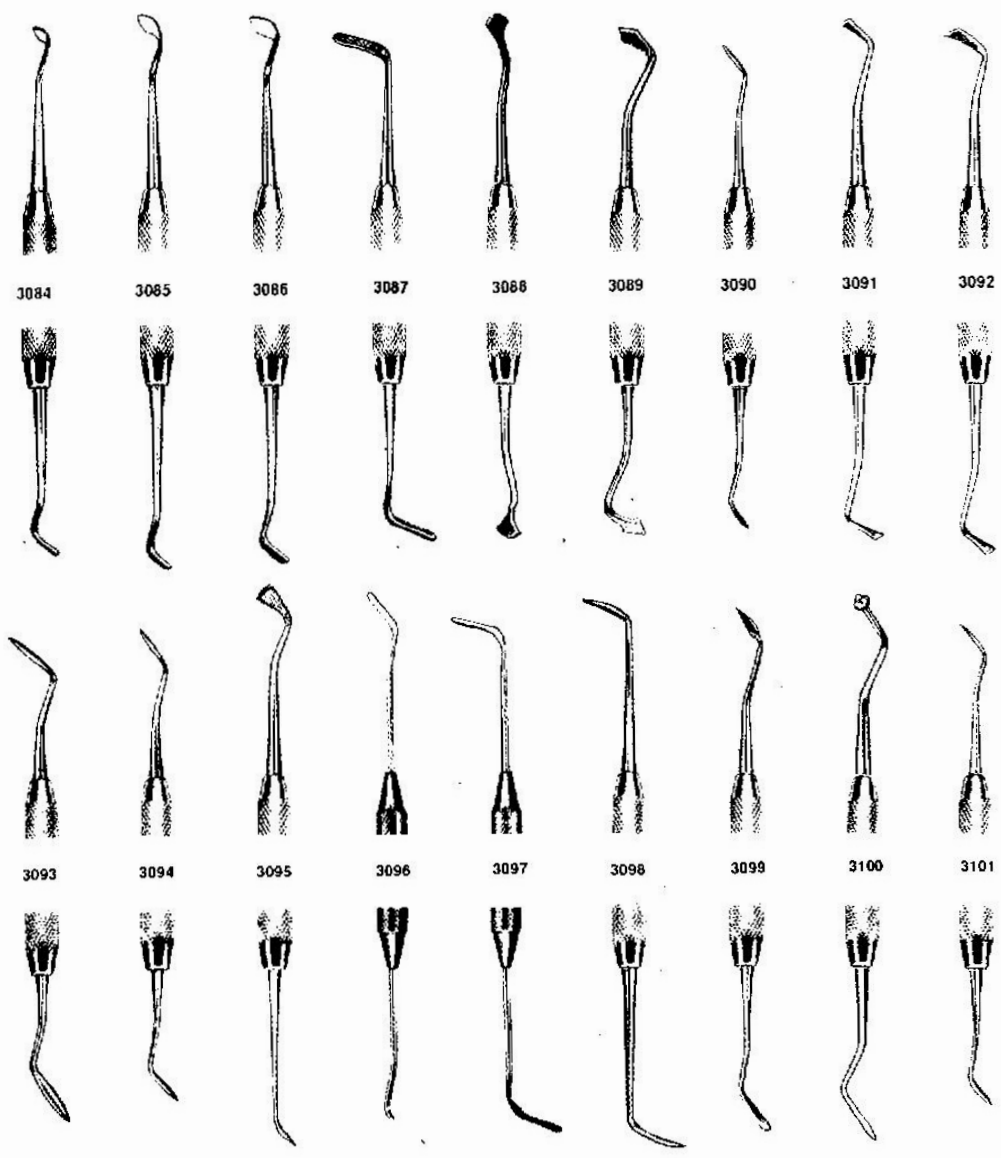

Also see Laboratory Wax Carvers at the end of this section.



**Plastic Filling/
Composite
Instruments**

Instrumente Fur Plastiche Fullungen Und Composite
Instrumentos para Obturaciones Plastica Y Composite
Instruments Pour Plombages Plastique Et Composite



3072



3073



3074



3075



3076



3077



3078



3079



3080



3081



3082



3083



3078



3079



3080



3081



3082



3083



3078



3079



3080



3081



3082



3083

— ENGLISH PATTERNS —



Gold Foil Instruments
Goldfolie Instrumente
Instrumentos Para Oro En Hojo
Instruments A Feuille D'Or

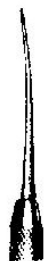

3121



3122



3123



3124



3125



3126



3127



3128



3129



3130



3131



3132



3133



3134



3135



3136



3137



3138



3139

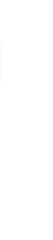

3140



3141



3142



3143

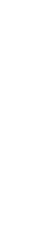

3144



3145



3146



3147



3148

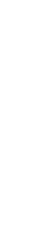

3149



3150

†Also available Left-Handed (please specify).



**Wax, Porcelain,
And Modeling
Carvers**

Wachs, Porzellan, Und Modellier Instrumente
Talladores Y Espatulas Para Cera Porcelana, Y Para Modelar
Instruments Et Spatules A Cire, A Porcelaine, Et A Sculpter

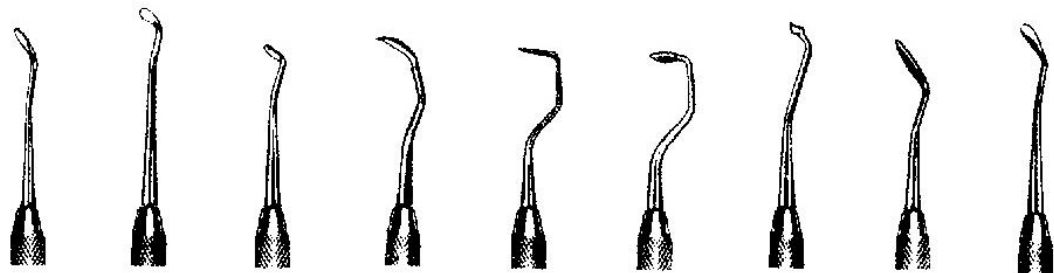

3102 3103 3104 3105 3106 3107 3108 3109 3110

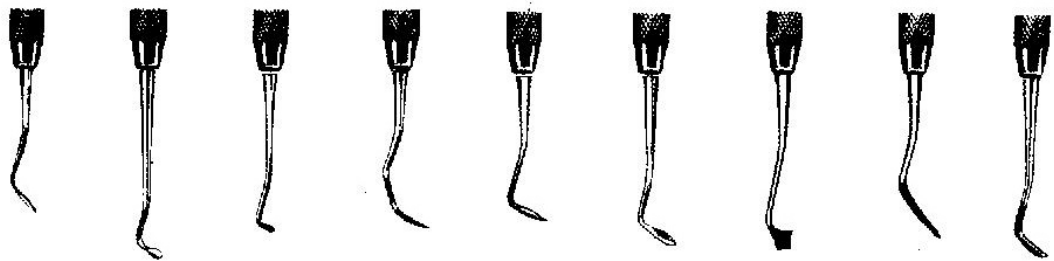

CL EOID-DISCOIDS

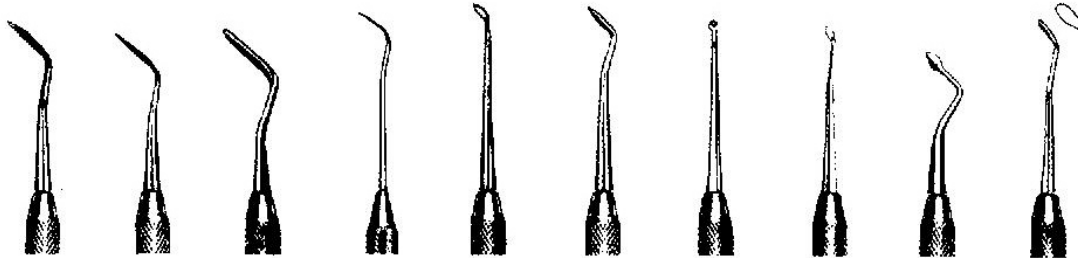

3111 3112 3113 3114 3115 3116 3117 3118 3119 3120

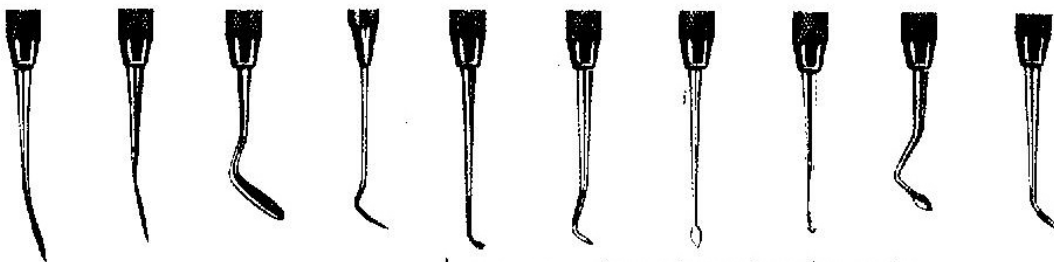

for carving amalgam. May also be used for burnishing inlay margins.



Gold Foil Instruments
Goldfolie Instrumente
Instrumentos Para Oro En Hojo
Instruments A Feuille D'Or

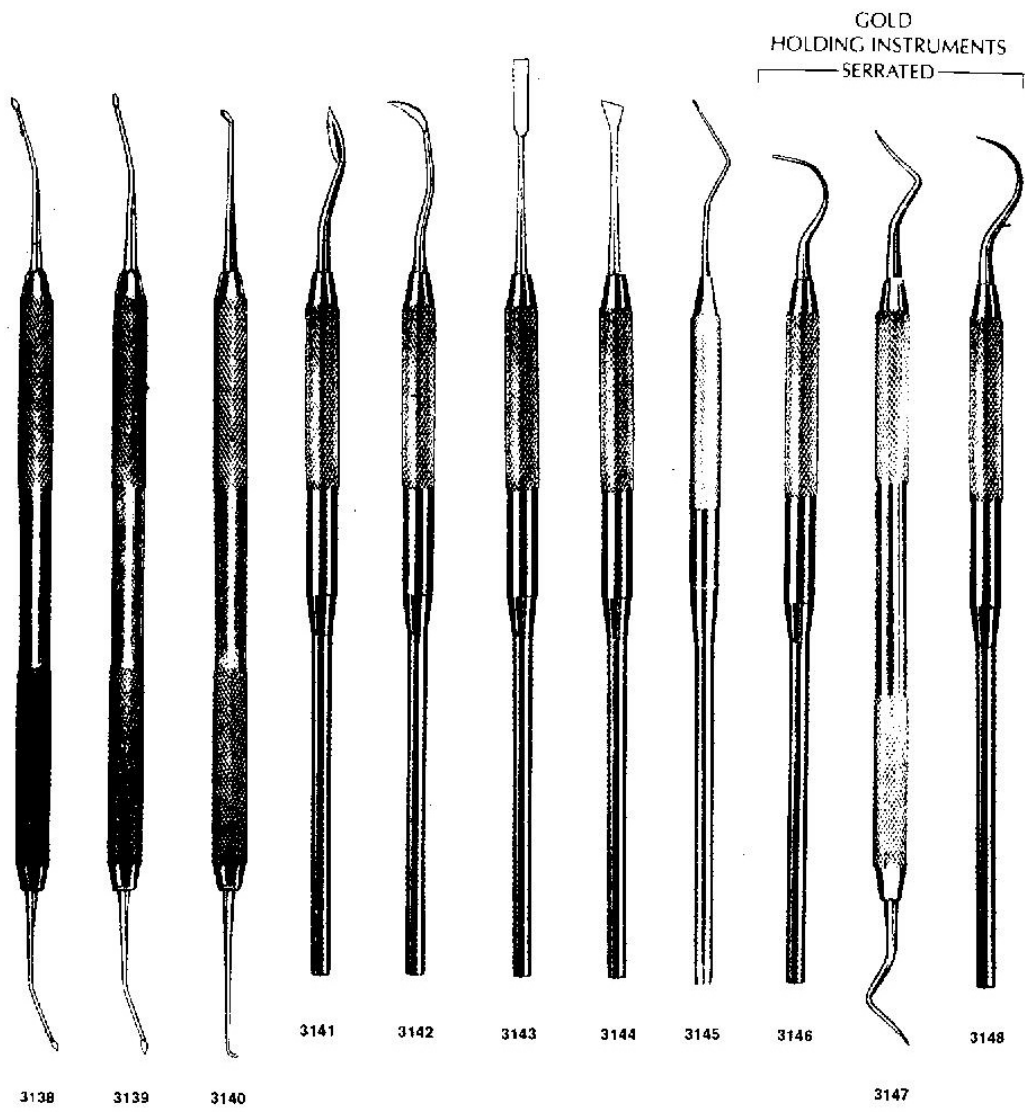



Gold Amalgam, & Composite Instruments
Gold, Amalgam, Und Composite Instrumente
Instrumentos Para Oro, Amalgama, Y Compuesto
Instruments Pour Or, Amalgame, Et Composite

AMALGAM FILES
Useful at gingival margins.

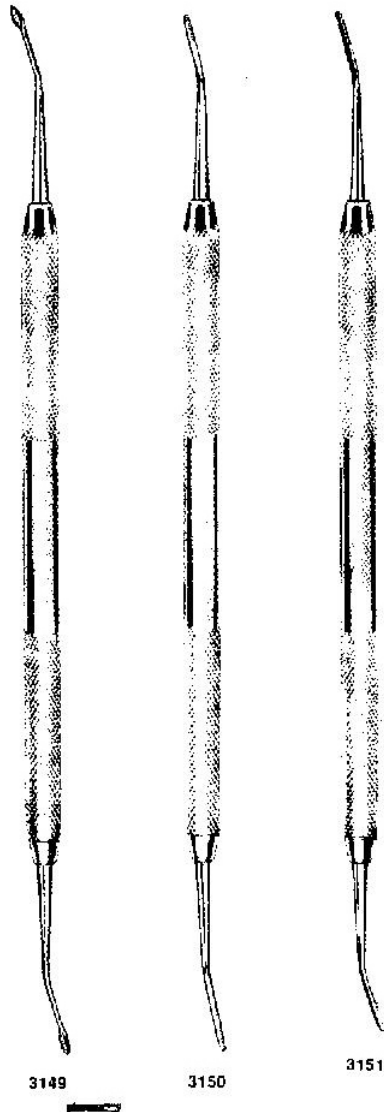

KNIVES
For trimming excess filling material.

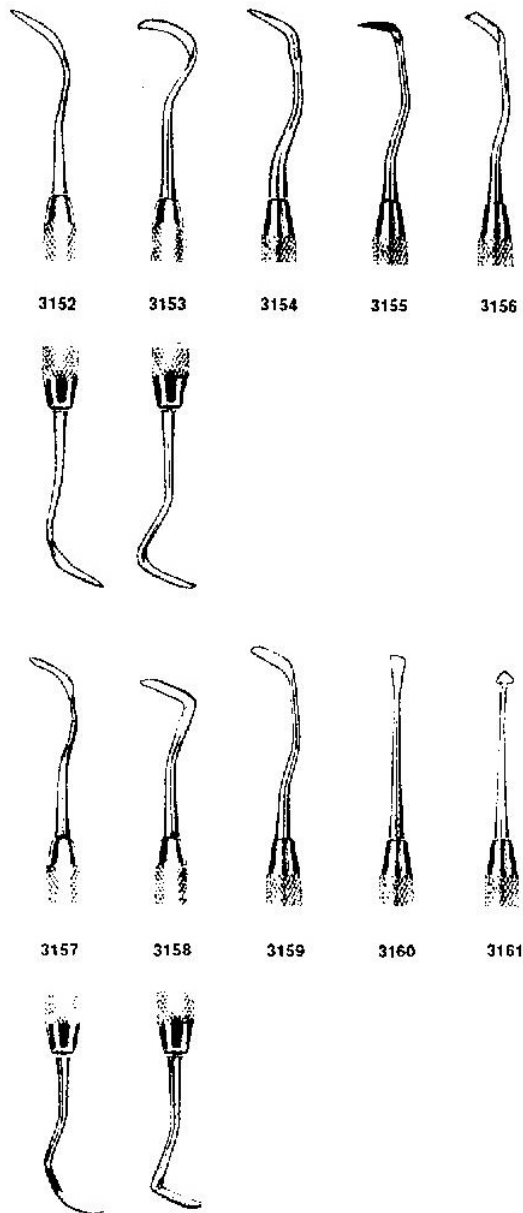



Laboratory Instruments

Labor Instruments
Instrumentos Para Laboratorio
Instruments Pour Techniciens

WAX CARVERS



WAX CARVER
3162

WAX CARVER
3163

WAX CARVER
3164



Used to flow wax on dentures.
3155

WAXING INSTRUMENTS

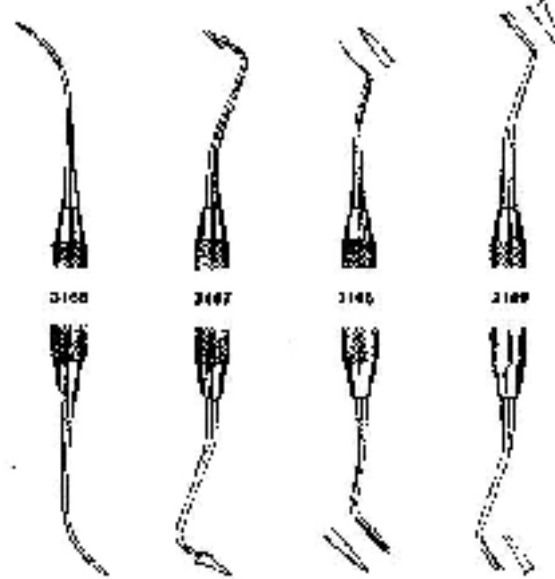

Used to flow wax on dentures.

Used to perfect and enhance eye, orbital and developmental areas.

Used to perfect external contour and remove excess wax at ear and face margins.

Used to finish or retrace wax as deep ridges and shallow grooves as well as form and correct all these ridges.

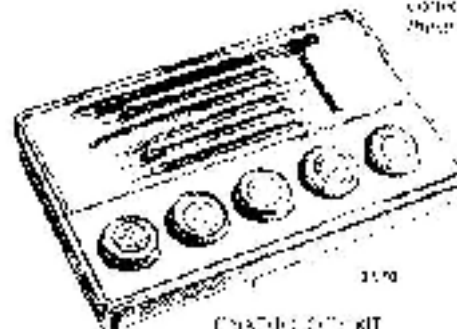

WAXING INSTRUMENT KIT
3170

This ready-to-use kit for finishing wax dentures, impressions, wax, includes waxing instruments for the upper and lower arches, wax, waxing medium, waxing oil, waxing paper, and waxing instrument cleaning solution.



Waxing instrument
3171

Waxing instrument
3172

WAX CARVERS 3162-3164

Laboratory Instruments

Labor Instrumentos
Instrumentos Para Laboratorio
Instruments Pour Techniciens

LABORATORY OPERATORY SPAULS



3173

3174

LABORATORY OPERATORY KNIFE



3175

Gauges & Calipers



3176

Measures thickness of crown's bevels and after casting. In 0.10 millimeter scale. 11 stop points for porcelain and metal (C, P), 11 stops for wax and plastic (C, P, 2).



3177

Wide application in Endodontic, Prosthetic, and Operative procedures. Calibrated in millimeters and 0.10 millimeter scale.

Gauges and calipers never to use.

Not available for the use of
patients and technicians.

Endodontic Instruments
Nervinstrumente
Instrumentos Para Nervios
Instruments A Nerfs

ROOT CANAL PLUGGERS

Used to compact and condense filling material vertically in a root canal.

**RETRO FILLING
[AMALGAM PLUGGERS]**



3178 3179

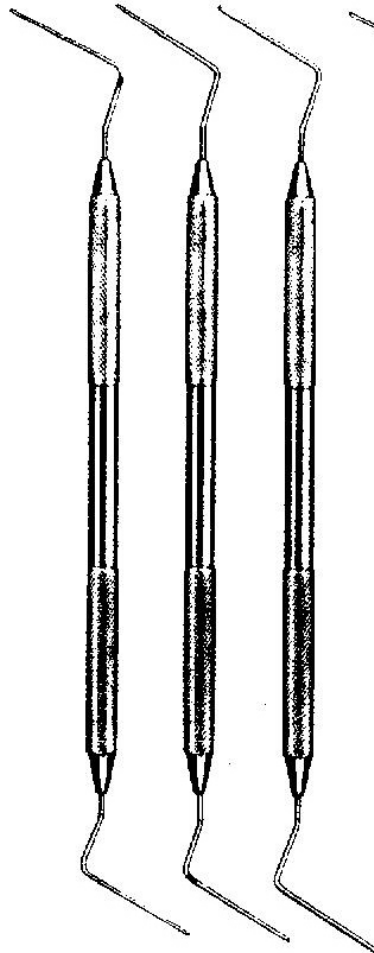

3180 3181 3182

VERTICAL CONDENSERS

Serrations at 5mm intervals for assessment of penetration depth.

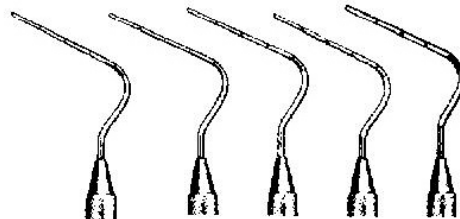

3184 3185 3186 3187

†Available in Anterior or Posterior models and 1/2 sizes. (Please specify.)

LUKS

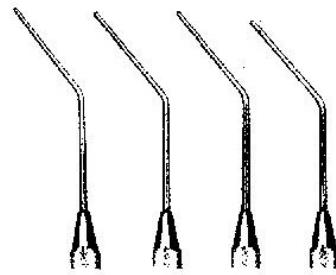

3188 3189 3190 3191

3183

For apical amalgam filling procedures. Small diameter ends allow easy fit into the root apex.



Endodontic Instruments Nervinstrumente
Instrumentos Para Nervios
Instruments A Nerfs

ROOT CANAL SPREADERS

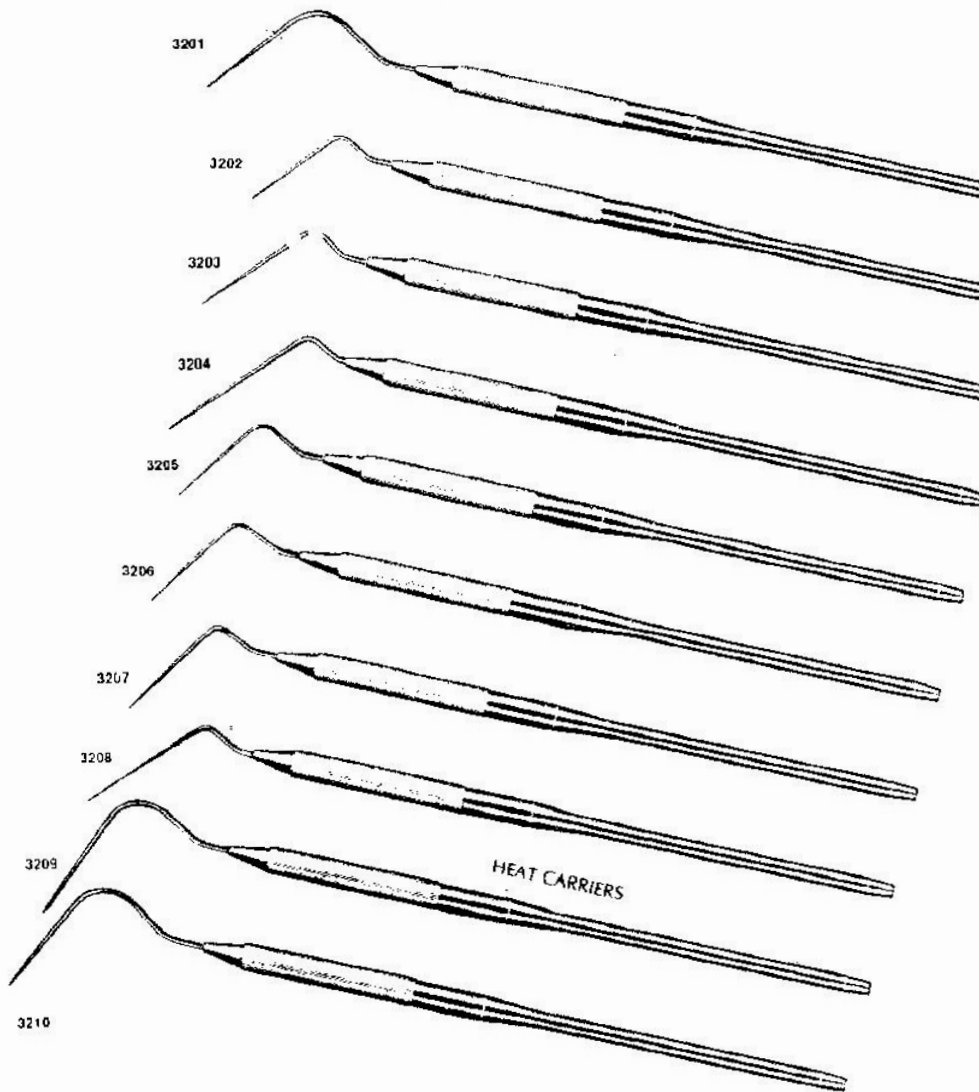

1Also available. Thinner styles. D-115 (RCSD115), D-117 (RCSD117), D-119 (RCSD119).
2Available in Anterior or Posterior models. (Please specify)

**Endodontic
Instruments**

Nervinstrumente
Instrumentos Para Nervios
Instruments A Nerfs

ENDO LOCKING PLIERS

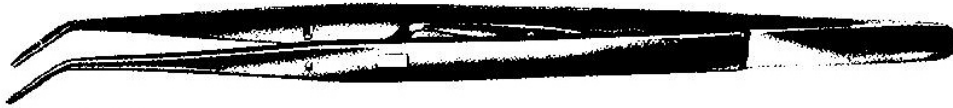

3211



*Horizontal & vertical grooves
for holding points.*

ROOT AND SILVER POINT FORCEPS

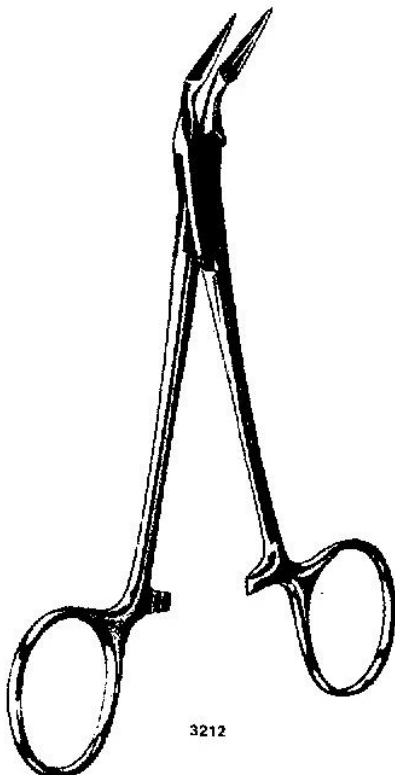

3212



3213



3214

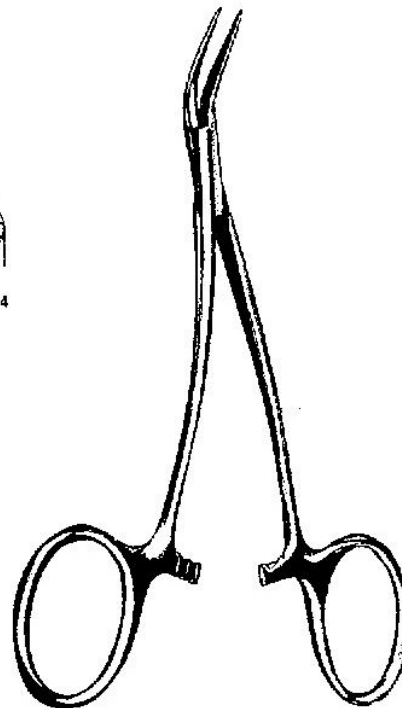

3215



RUBBER DAM INSTRUMENTS
KOFFERDAM INSTRUMENTE
INSTRUMENTOS PARA GOMA DIQUE
CRAMPONS A DIGUE

RUBBER DAM CLAMPS

MOLAR CLAMPS
With Dam-Engaging Projections (winged)

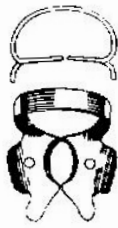

3215

Lower Molars. Small molar clamp. Flat jaws avoid gum impingement.



3217

Upper Molars. Same size as No. 3, but with festooned jaws that conform to the gum line and provide stable contact.



3218

Upper Molars. Large molar clamp. Festooned jaws conform to the curvature of the gum line and resist rotation.



3219

Upper Molars. Festooned jaws conform to the gum line and provide stability.



3220

For molar roots and partially erupted or irregularly-shaped smaller molars. Jaws have a four-point contact at the corners. Also useful as a Pedodontic molar clamp.



3221

Right and Left Molars. Particularly well-suited for third molars, but also useful for all lower molars. Serrated jaws. Offset jaw height provides stability over a wide range of conditions, including partially-erupted teeth.

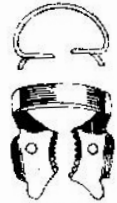

3222



3223

For partially-erupted or irregularly-shaped molars. Jaws are festooned for stable grip.



3224

Large molar clamp. For large partially-erupted or irregularly-shaped molars. Jaws are deeply festooned and have a four-point contact at the corners.



3225

Lower Molars. General purpose clamp. Flat jaws avoid gum impingement.



3226

Upper Molars. Similar to No. 200, but with slightly more rounded jaws. Festooned jaws conform to gum line curvature and provide stability.



3227

Lower Molars. Large molar clamp. Similar to No. 200, but with larger jaws. Flat jaws avoid gum impingement.



3228

Right and Left Molars. For all small molars, but particularly recommended for lower molars. Also well-suited for Pedodontic application. Low bow.



3229



3230

Upper Molars. Large molar clamp. Stiff spring for firm hold on large molars. Moderately-festooned jaws conform to gum line and provide stability.



RUBBER DAM INSTRUMENTS KOFFERDAM INSTRUMENTE INSTRUMENTOS PARA GOMA DIQUE CRAMPONS A DIGUE

RUBBER DAM CLAMPS

MOLAR CLAMPS

Without Dam-Engaging Projections (wingless)



3231

For molar roots and partially-erupted or irregularly-shaped smaller molars. Jaws have a four-point contact at the corners. Also useful as a Pedodontic molar clamp.



3232

For partially-erupted or irregularly-shaped molars. Jaws are festooned for stable grip.



3233

Large molar clamp. For partially-erupted or irregularly-shaped large molars. Jaws are deeply festooned and have a four-point contact at the corners.



3234

Lower Molars. Large molar clamp. Large bow and jaws. Flat jaws avoid gum impingement.



3235

Delos Palmer molar clamp. Stiff bow.



3236

Left and Right Molars. For subgingival cavities on the buccal or lingual surfaces.



3237



3238

Upper Molars. Festooned jaws conform to gum curvature and provide stability.



3239

Lower Molars. Broad flange jaws provide increased clearance between dam surface and tooth crown. Flat jaws and reverse jaw bevel avoid gum impingement.



3240



3241

Festooned jaws conform to gum line curvature. Both flanges are beaked for stable grip.



3242

Left and Right Molars. Especially well-suited for third molars. Also useful for molar buccal cavities that extend below gingival line. Serrated jaws. Offset jaw height provides stability over a wide range of conditions, including partially-erupted teeth.

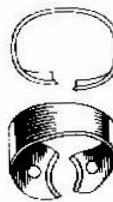

3243



3244

Left and Right Molars. Beaked and festooned jaws provide stability.



RUBBER DAM INSTRUMENTS
KOFFERDAM INSTRUMENTE
INSTRUMENTOS PARA GOMA DIQUE
CRAMPONS A DIGUE

RUBBER DAM CLAMPS

BICUSPID CLAMPS

With Dam-Engaging Projections (winged)



3245

Narrow jaws for small bicuspids. High bow for extra clearance.



3246

For upper and lower bicuspids. Festooned jaws fit gum line curvature and provide stability.



3247

For upper and lower bicuspids. Same as No. 206, but with flat jaws that avoid gum impingement.



3248

Similar to No. 207 (flat jaws), but with larger jaws that adapt to large bicuspids.



3249

Primarily for lower bicuspids. Small, flat jaws for small bicuspids. Stiff bow.

BICUSPID CLAMPS

Without Dam-Engaging Projections (wingless)



3250

For upper and lower bicuspids. Flat jaws avoid gum impingement.



3251

For upper and lower bicuspids. Festooned jaws conform to curvature at gum line and provide stability.

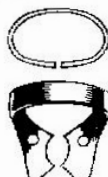

3252

Primarily for lower bicuspids. Broad flange jaws provide increased clearance between dam surface and tooth crown. Flat jaws and reverse jaw bevel avoid gum impingement.

LABIAL CLAMPS

With Dam-Engaging Projections (winged)



3253

For labial cavities on centrals and cuspids. Also useful in some cases for bicuspids.



3254

Universal clamp for labial cavities on anterior teeth and bicuspids.

CERVICAL CLAMPS



3255

For labial cavities on anterior teeth.



3256

Soft tension formable modification.



3257

Offset jaw modification provides extra margin of protection for lingual tissues.



DENTAL INSTRUMENTS

**MATERIAL
STAINLESS
STEEL
or
CHROME
PLATED**



3258



3259



3260

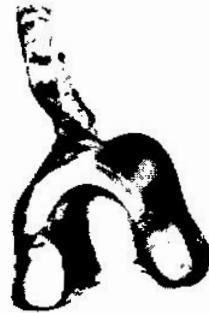

3261



3262



3263



3264



3265



3266

IMPRESSION TRAYS PLAIN



3267



3268



3269

PERFORATED



3270



3271



3272



DENTAL INSTRUMENTS



3273
No.3



3274
No.7



3275
No.4



3276
SECCO



3277



3278

1/2

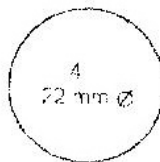

4
22 mm Ø



5
24 mm Ø



3279
plane, simple thread
size 22 mm.
size 24 mm.



3280
magnifying, simple thread
size 22 mm.
size 24 mm.



AMALGAM CARRIERS DOUBLE, SINGLE & DOUBLE REMOVER

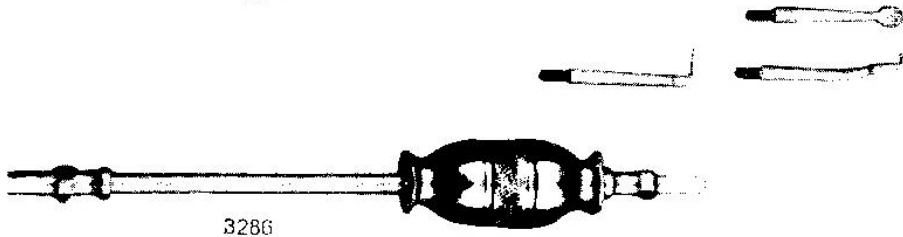
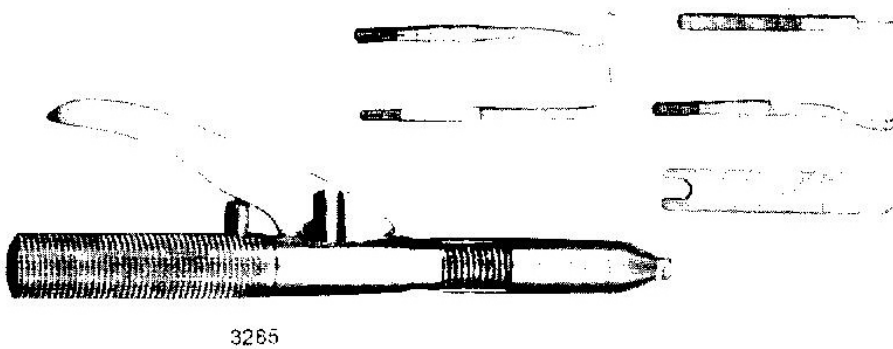
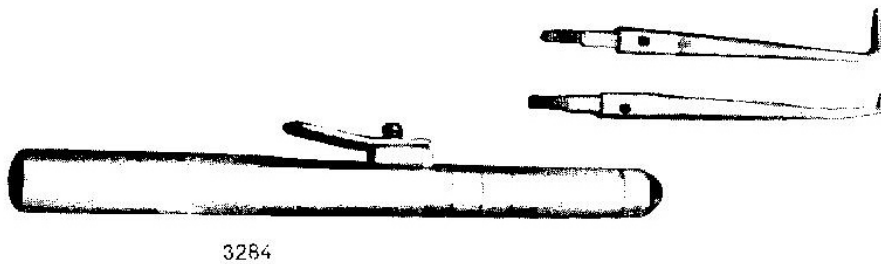
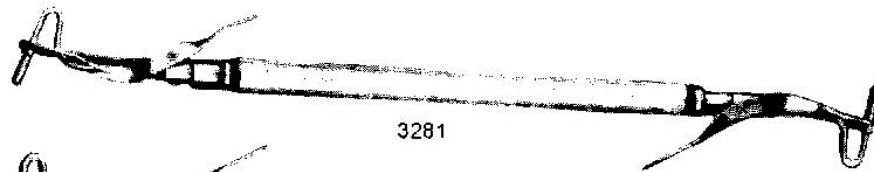



ASPIRATING SYRINGES & AMALGAM CARRIER SINGLE

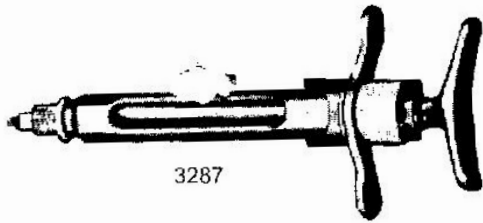

3287

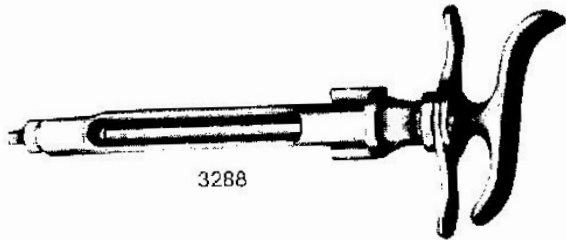

3288

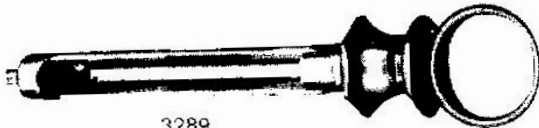

3289

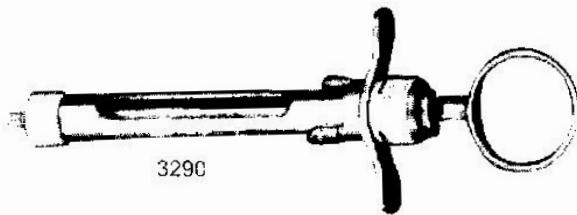

3290

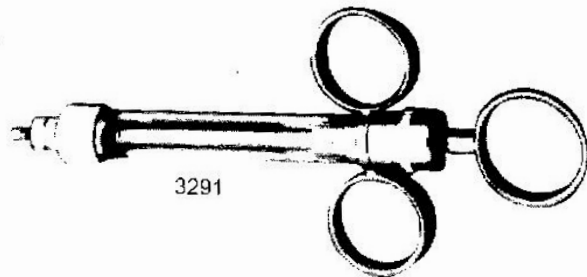

3291



3292



3293



3294



3297



MEASURING INSTRUMENTS & MATRIX RETAINERS

